

42 Stringybark Avenue

Ground Floor

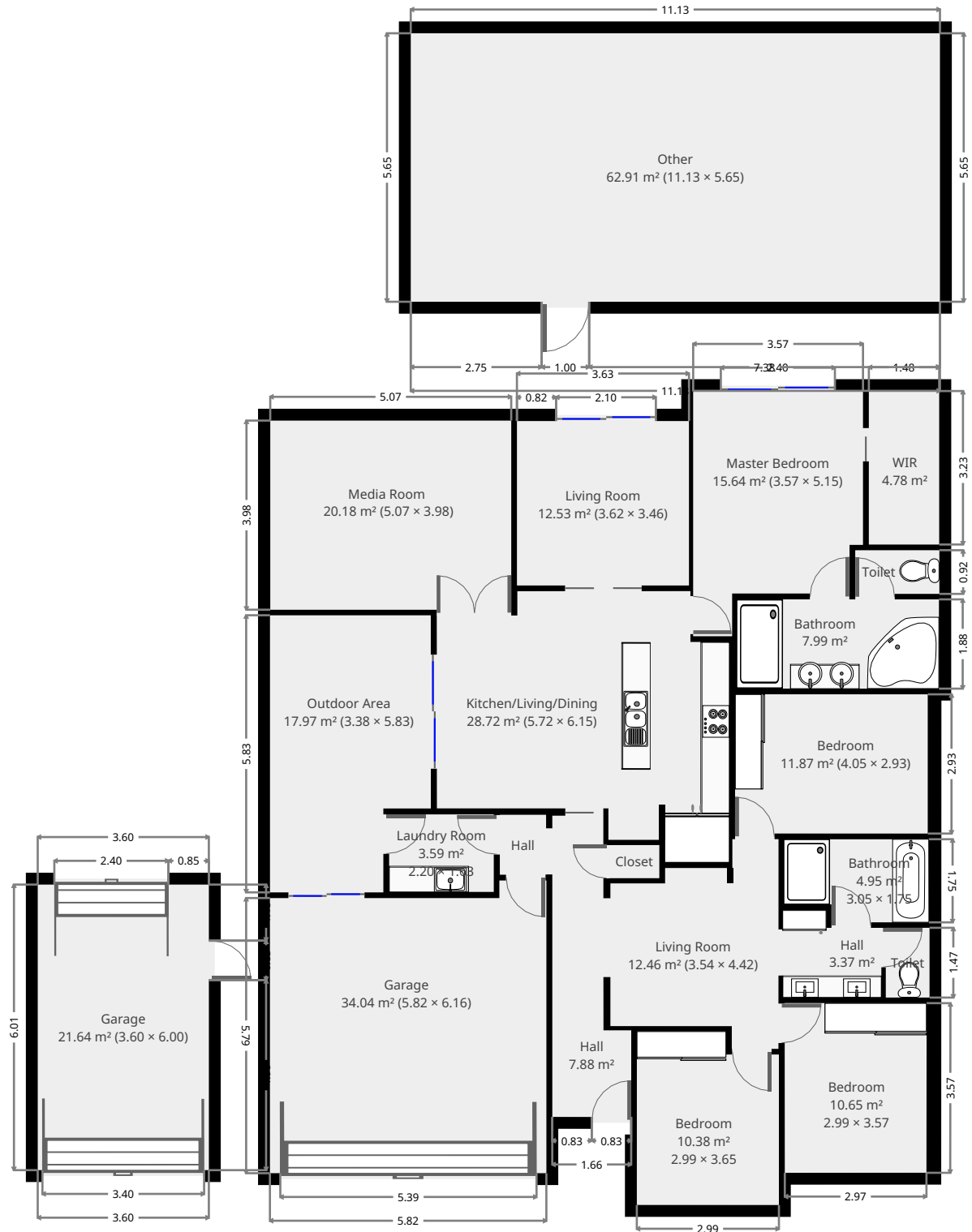

THIS FLOORPLAN IS PROVIDED WITHOUT WARRANTY OF ANY KIND. SENSOPIA DISCLAIMS ANY WARRANTY INCLUDING, WITHOUT LIMITATION, SATISFACTORY QUALITY OR ACCURACY OF DIMENSIONS.



42 Stringybark Avenue

Garage

Width: 5.82 m
Length: 6.16 m
Area: 34.04 m²
Perimeter: 23.95 m

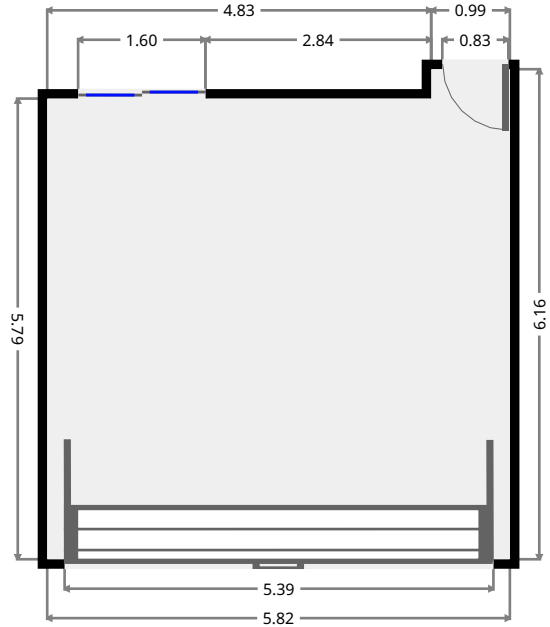
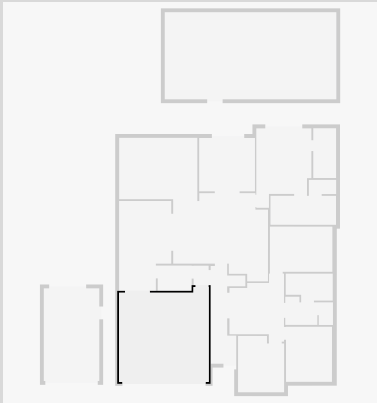

Other

Width: 5.65 m
Length: 11.13 m
Area: 62.91 m²
Perimeter: 33.57 m

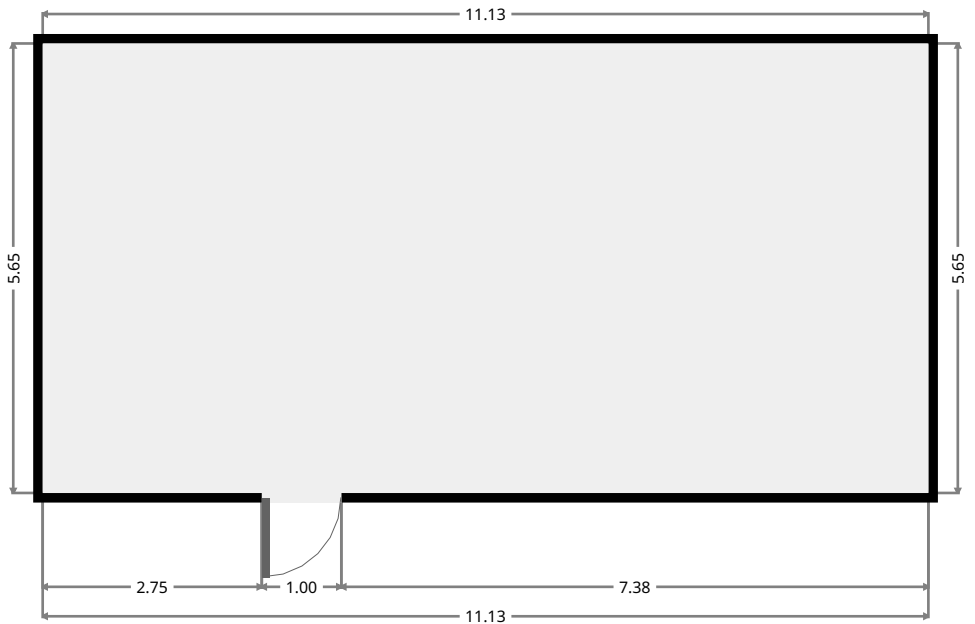
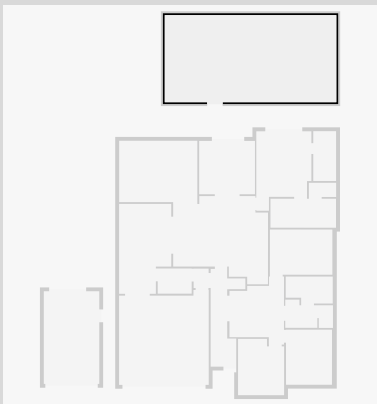

42 Stringybark Avenue

Garage

Width: 3.60 m
 Length: 6.00 m
 Area: 21.64 m²
 Perimeter: 19.22 m

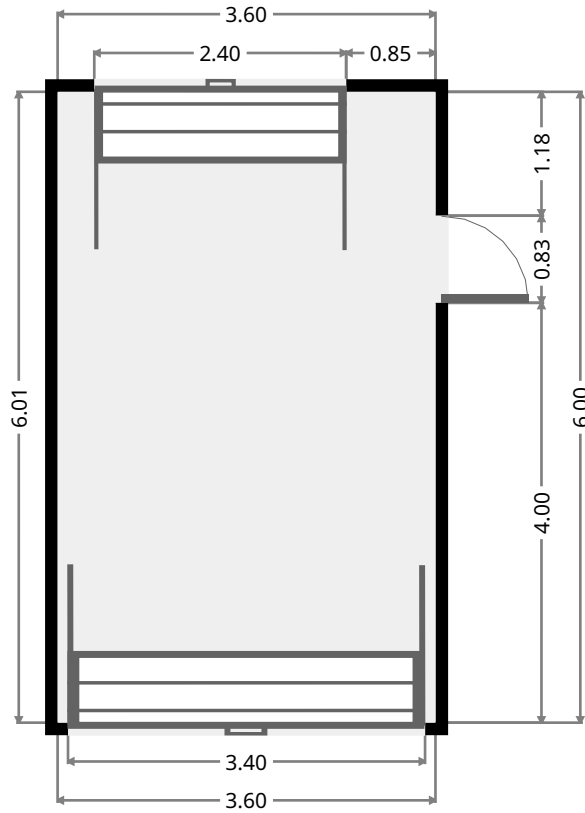
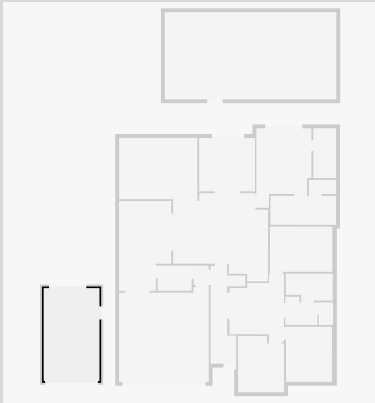

Outdoor Area

Width: 3.38 m
 Length: 5.83 m
 Area: 17.97 m²
 Perimeter: 18.43 m

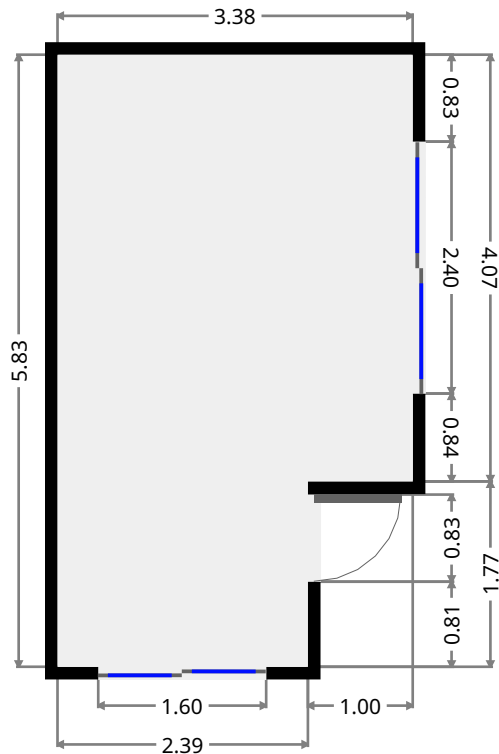
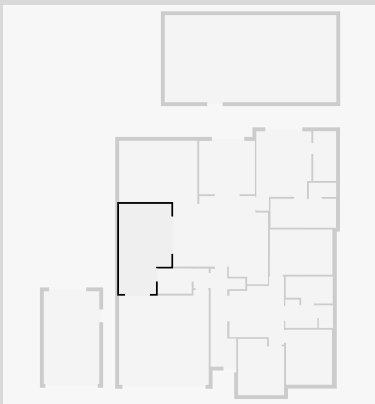

THIS FLOORPLAN IS PROVIDED WITHOUT WARRANTY OF ANY KIND. SENSOPIA DISCLAIMS ANY WARRANTY INCLUDING, WITHOUT LIMITATION, SATISFACTORY QUALITY OR ACCURACY OF DIMENSIONS.

42 Stringybark Avenue

Living Room

Width: 3.46 m
 Length: 3.62 m
 Area: 12.53 m²
 Perimeter: 14.16 m

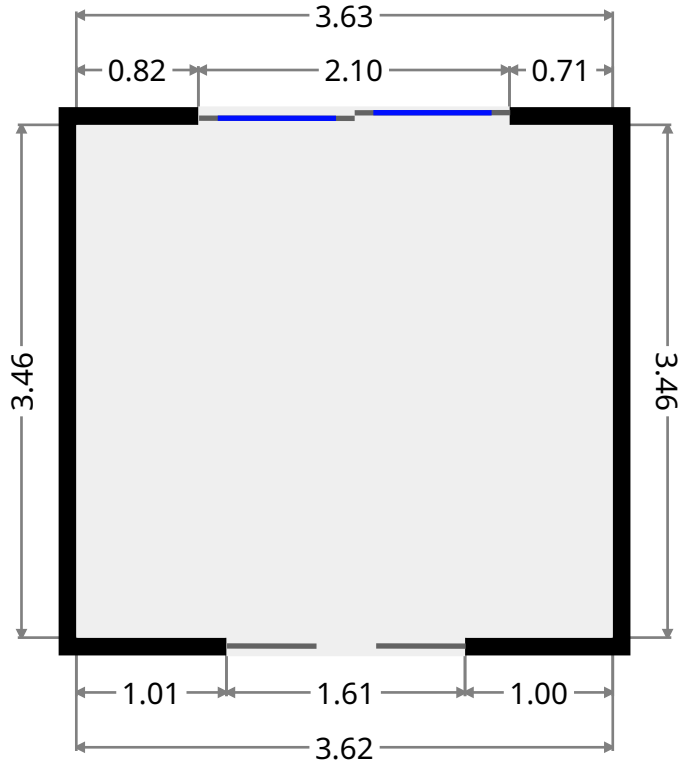
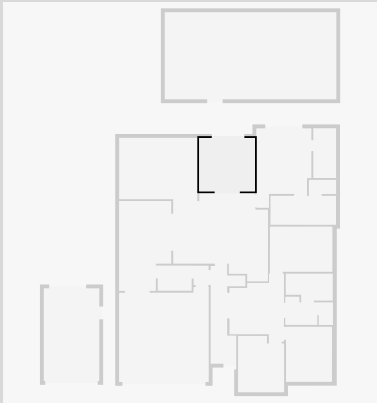

Media Room

Width: 3.98 m
 Length: 5.07 m
 Area: 20.18 m²
 Perimeter: 18.10 m

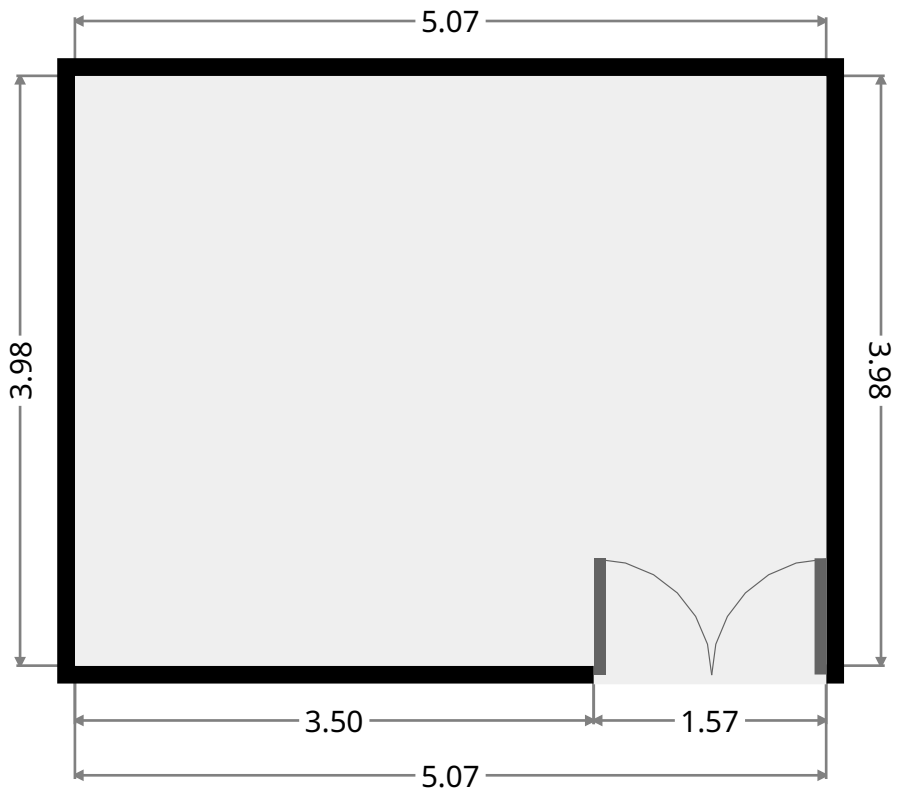
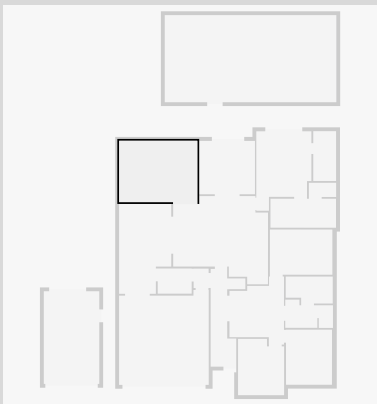

THIS FLOORPLAN IS PROVIDED WITHOUT WARRANTY OF ANY KIND. SENSOPIA DISCLAIMS ANY WARRANTY INCLUDING, WITHOUT LIMITATION, SATISFACTORY QUALITY OR ACCURACY OF DIMENSIONS.

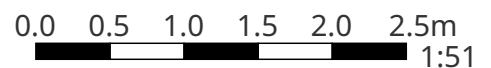

42 Stringybark Avenue

Toilet

Width: 0.92 m
Length: 1.77 m
Area: 1.63 m²
Perimeter: 5.38 m

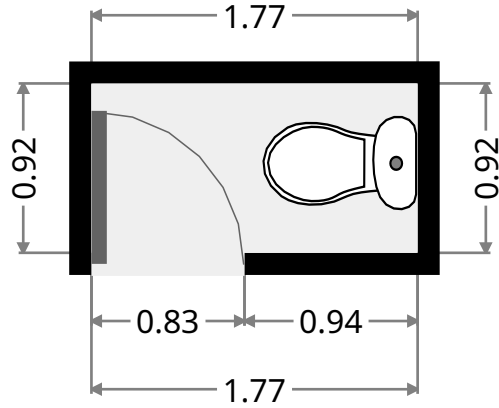
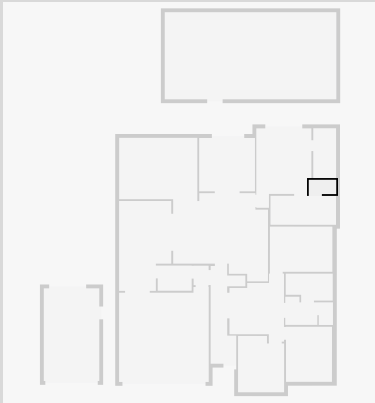

WIR

Width: 1.48 m
Length: 3.23 m
Area: 4.78 m²
Perimeter: 9.42 m

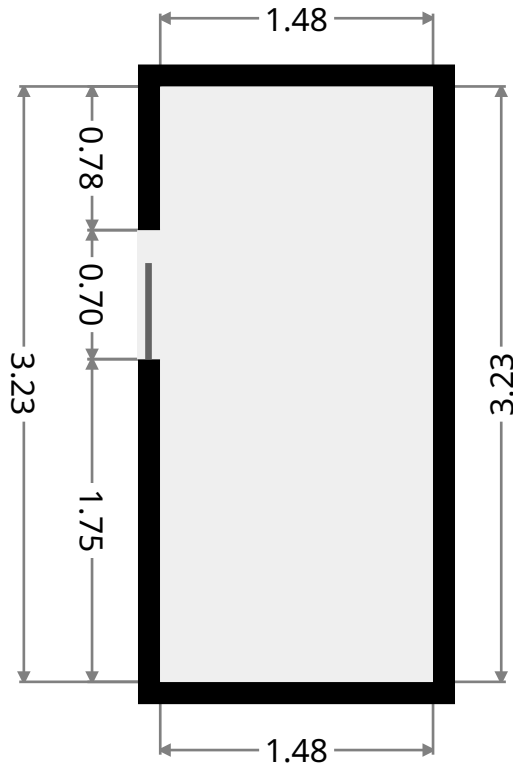
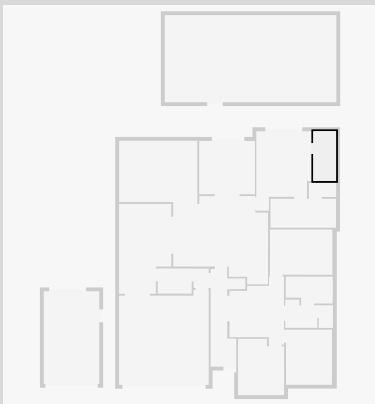

42 Stringybark Avenue

Bathroom

Width: 1.88 m
 Length: 4.25 m
 Area: 7.99 m²
 Perimeter: 12.26 m

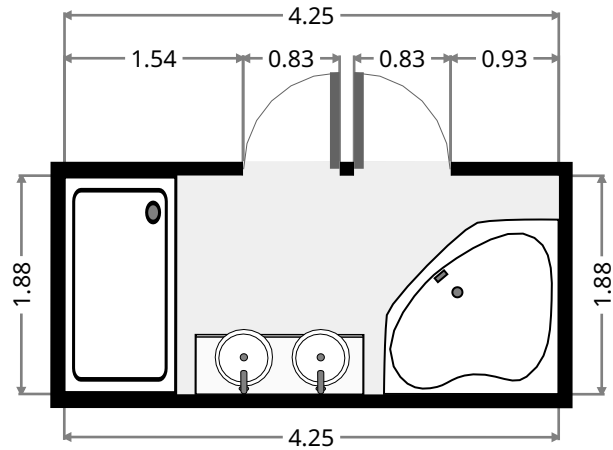
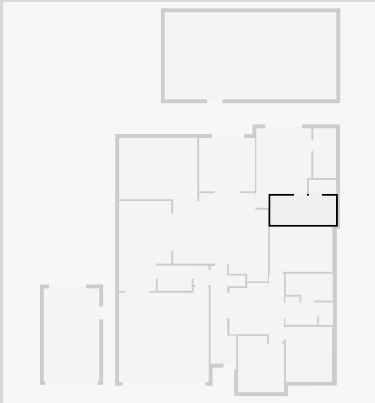

Master Bedroom

Width: 3.57 m
 Length: 5.15 m
 Area: 15.64 m²
 Perimeter: 17.45 m
 Ceiling Height: 1.05 m

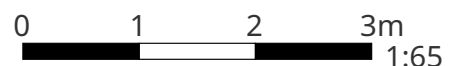
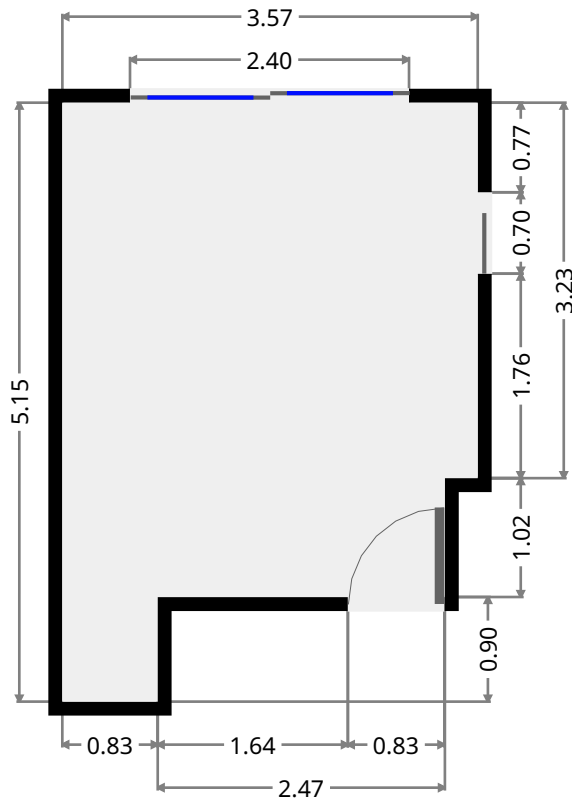
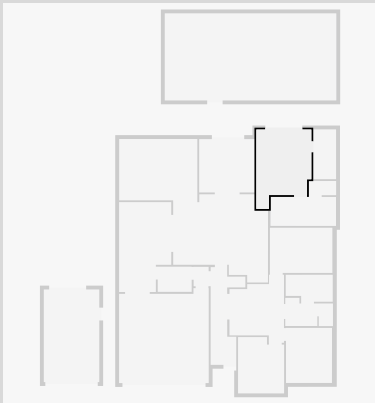

THIS FLOORPLAN IS PROVIDED WITHOUT WARRANTY OF ANY KIND. SENSOPIA DISCLAIMS ANY WARRANTY INCLUDING, WITHOUT LIMITATION, SATISFACTORY QUALITY OR ACCURACY OF DIMENSIONS.

42 Stringybark Avenue

Kitchen/Living/Dining

Width: 5.72 m
 Length: 6.15 m
 Area: 28.72 m²
 Perimeter: 23.75 m

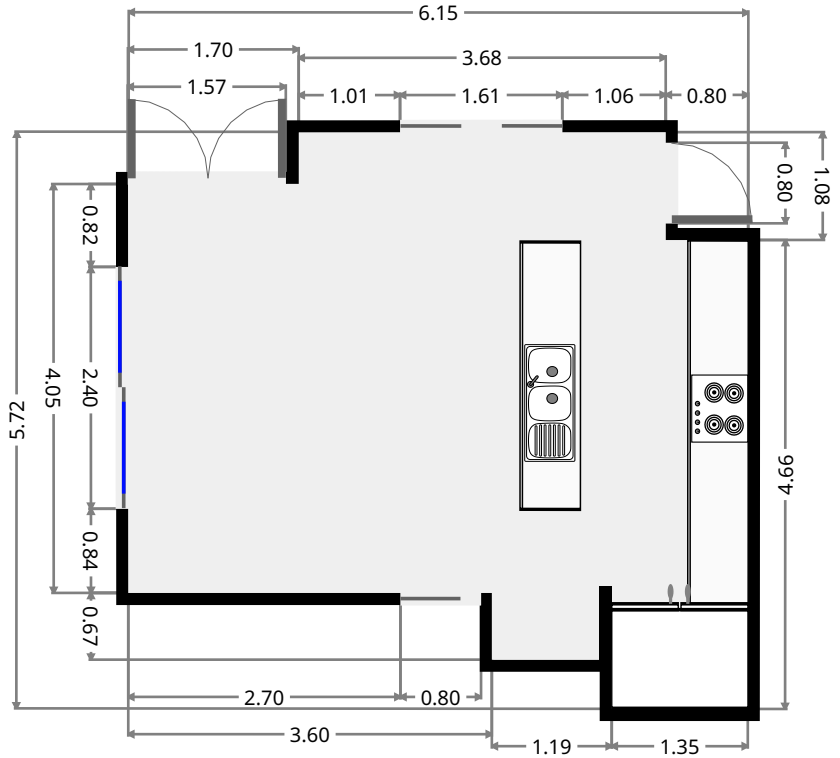
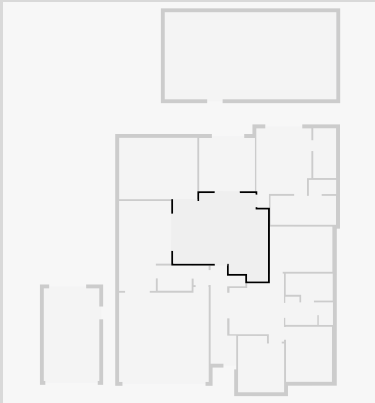

Hall

Width: 1.66 m
 Length: 6.33 m
 Area: 7.88 m²
 Perimeter: 16.00 m

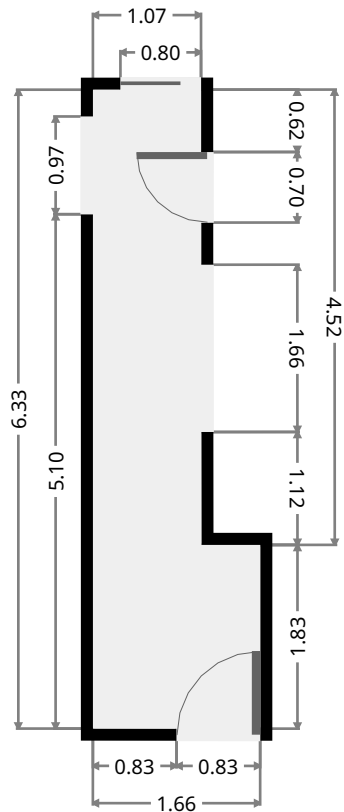
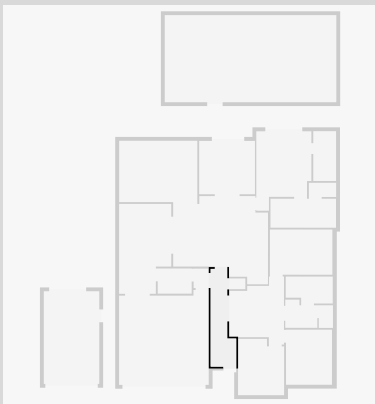

THIS FLOORPLAN IS PROVIDED WITHOUT WARRANTY OF ANY KIND. SENSOPIA DISCLAIMS ANY WARRANTY INCLUDING, WITHOUT LIMITATION, SATISFACTORY QUALITY OR ACCURACY OF DIMENSIONS.

42 Stringybark Avenue

Laundry Room

Width: 1.63 m
 Length: 2.20 m
 Area: 3.59 m²
 Perimeter: 7.66 m

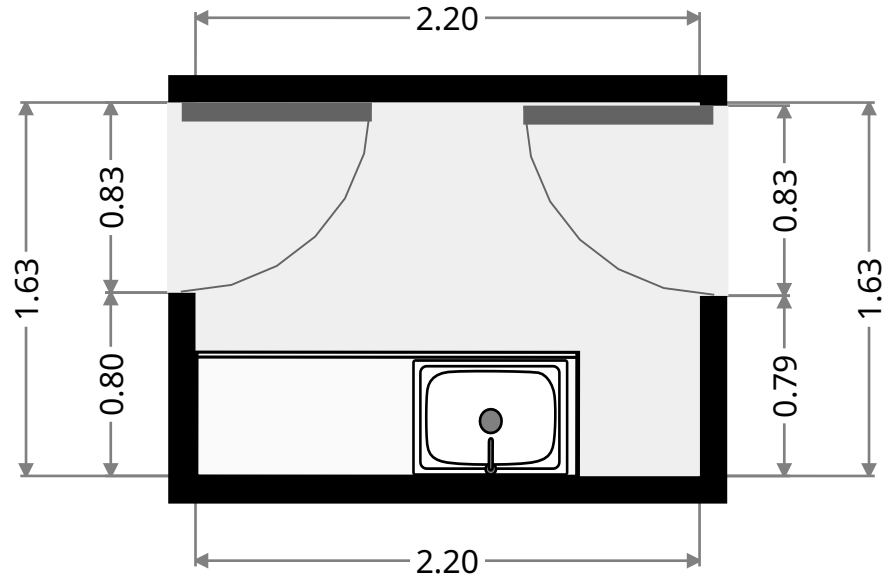
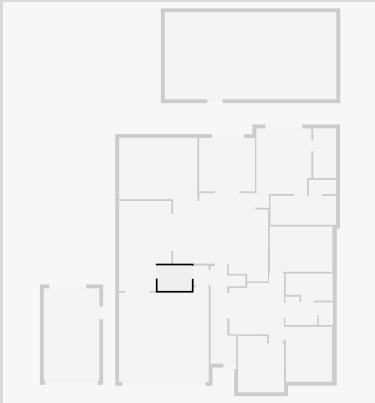

Hall

Width: 0.97 m
 Length: 1.26 m
 Area: 1.23 m²
 Perimeter: 4.47 m

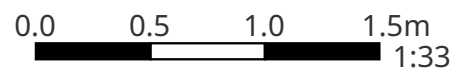
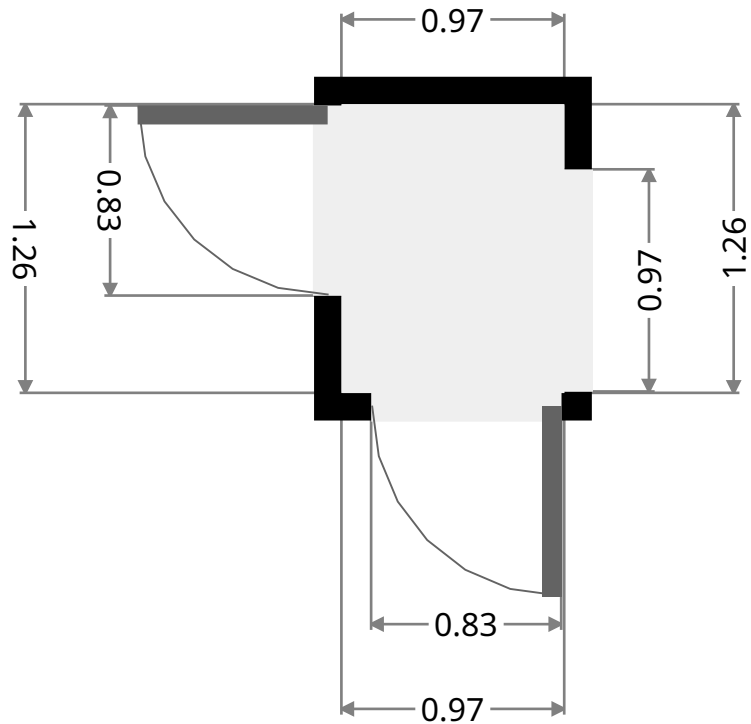
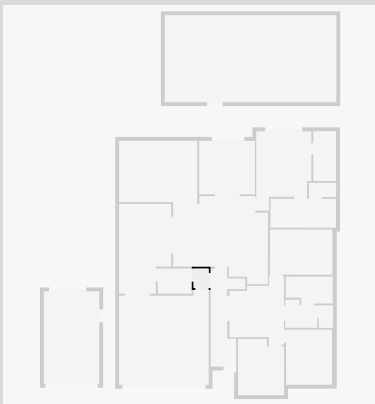

THIS FLOORPLAN IS PROVIDED WITHOUT WARRANTY OF ANY KIND. SENSOPIA DISCLAIMS ANY WARRANTY INCLUDING, WITHOUT LIMITATION, SATISFACTORY QUALITY OR ACCURACY OF DIMENSIONS.

42 Stringybark Avenue

Closet

Width: 0.70 m
Length: 1.05 m
Area: 0.73 m²
Perimeter: 3.50 m

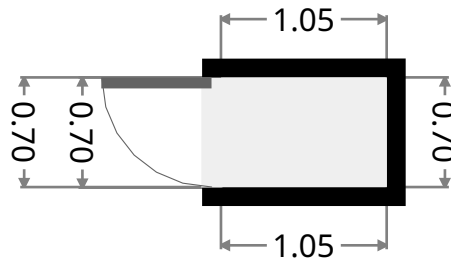
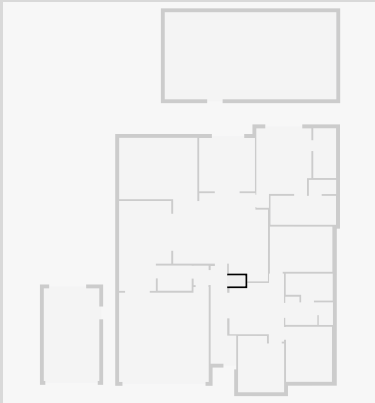

Bedroom

Width: 2.99 m
Length: 3.65 m
Area: 10.38 m²
Perimeter: 13.29 m

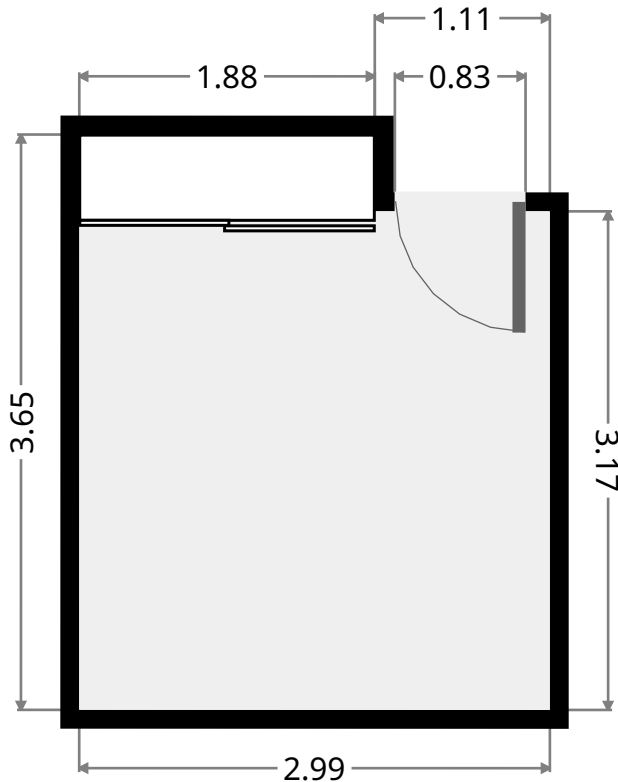
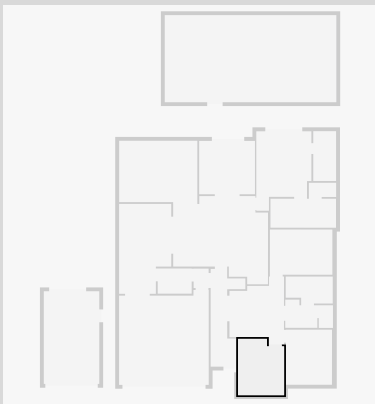

42 Stringybark Avenue

Bedroom

Width: 2.99 m
 Length: 3.57 m
 Area: 10.65 m²
 Perimeter: 13.11 m

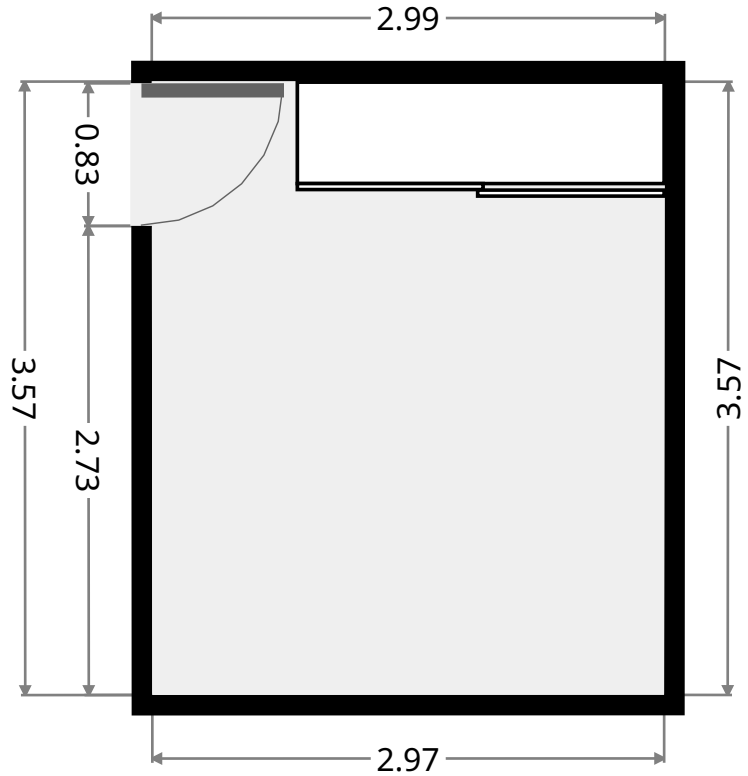
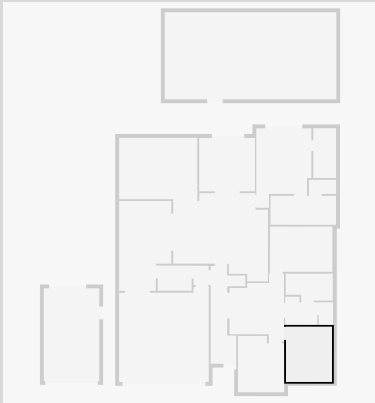

Bathroom

Width: 1.75 m
 Length: 3.05 m
 Area: 4.95 m²
 Perimeter: 9.60 m

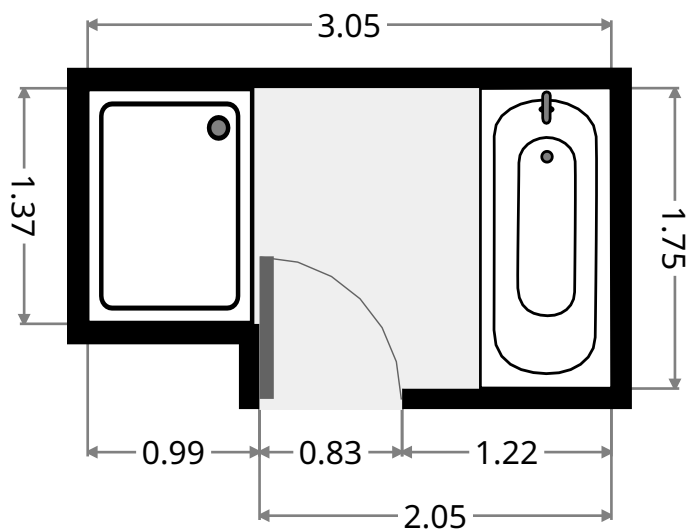
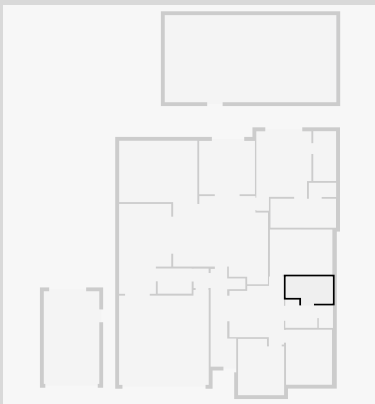

42 Stringybark Avenue

Toilet

Width: 0.92 m
 Length: 1.47 m
 Area: 1.35 m²
 Perimeter: 4.78 m

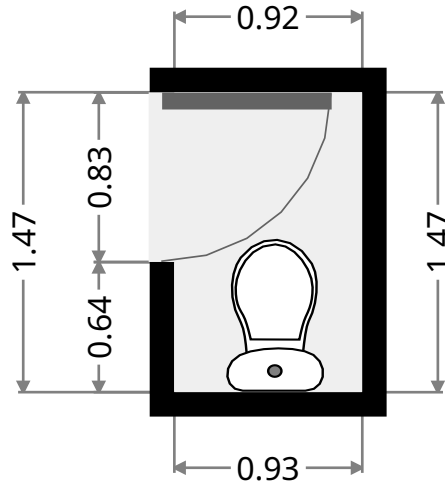
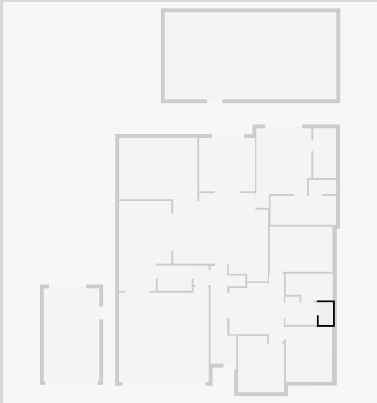

Hall

Width: 1.83 m
 Length: 2.09 m
 Area: 3.37 m²
 Perimeter: 7.81 m

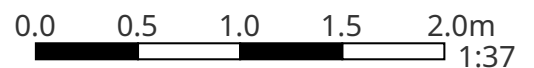
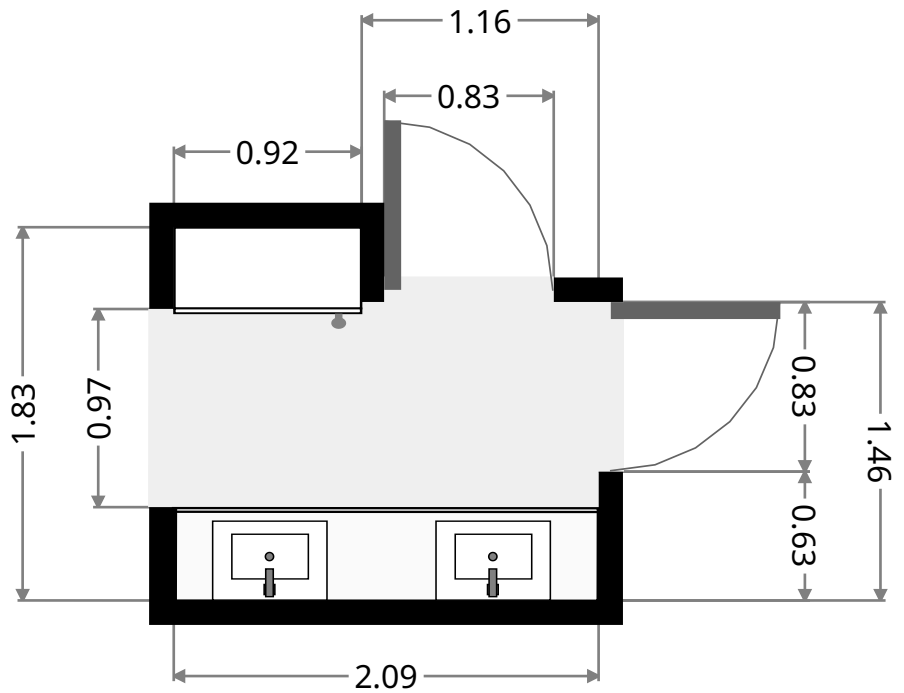
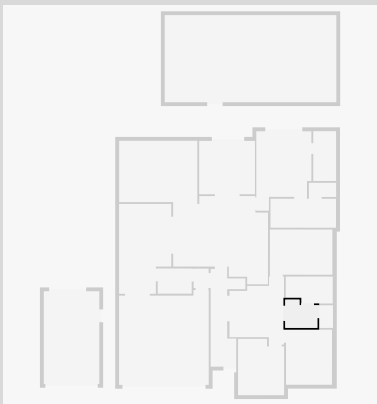

THIS FLOORPLAN IS PROVIDED WITHOUT WARRANTY OF ANY KIND. SENSOPIA DISCLAIMS ANY WARRANTY INCLUDING, WITHOUT LIMITATION, SATISFACTORY QUALITY OR ACCURACY OF DIMENSIONS.

42 Stringybark Avenue

Bedroom

Width: 2.93 m
Length: 4.05 m
Area: 11.87 m²
Perimeter: 13.97 m

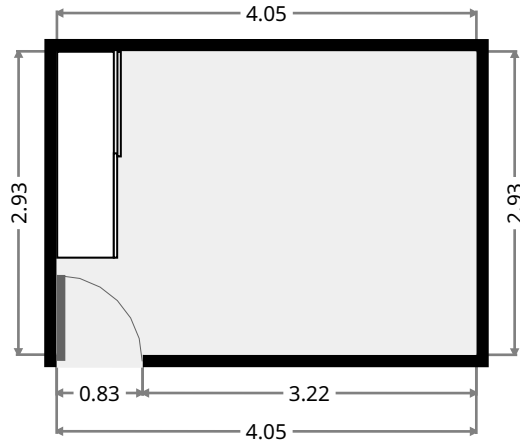
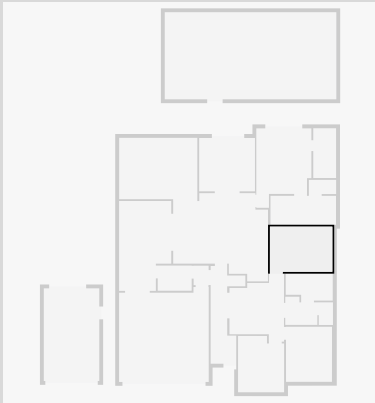

Living Room

Width: 3.54 m
Length: 4.42 m
Area: 12.46 m²
Perimeter: 15.90 m

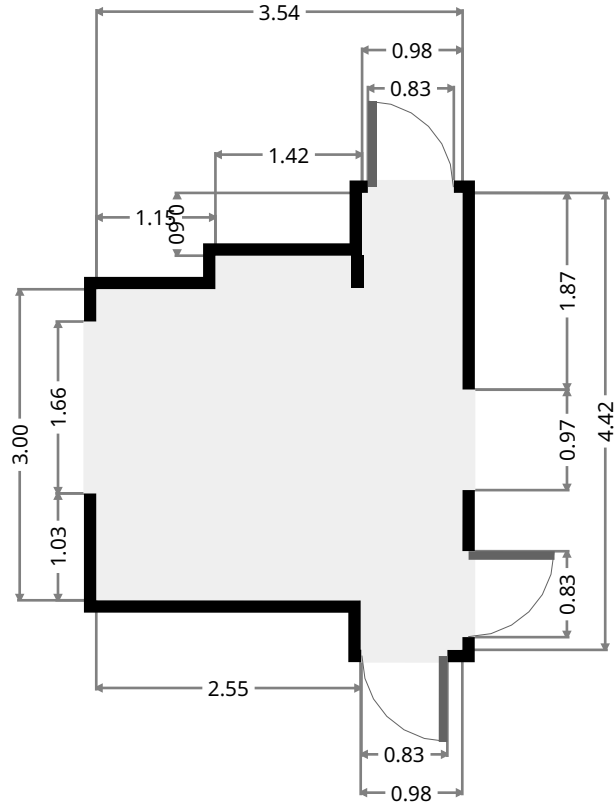
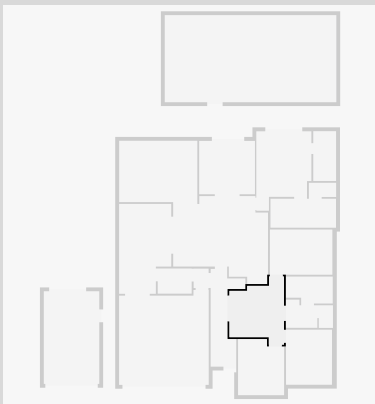

THIS FLOORPLAN IS PROVIDED WITHOUT WARRANTY OF ANY KIND. SENSOPIA DISCLAIMS ANY WARRANTY INCLUDING, WITHOUT LIMITATION, SATISFACTORY QUALITY OR ACCURACY OF DIMENSIONS.