

42 Schlenker Drive

Ground Floor

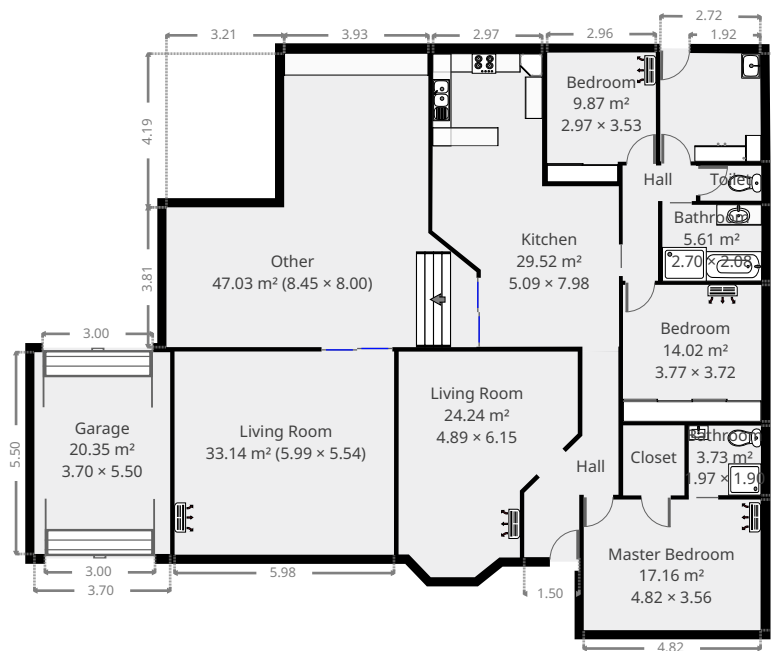

THIS FLOORPLAN IS PROVIDED WITHOUT WARRANTY OF ANY KIND. SENSOPIA DISCLAIMS ANY WARRANTY INCLUDING, WITHOUT LIMITATION, SATISFACTORY QUALITY OR ACCURACY OF DIMENSIONS.

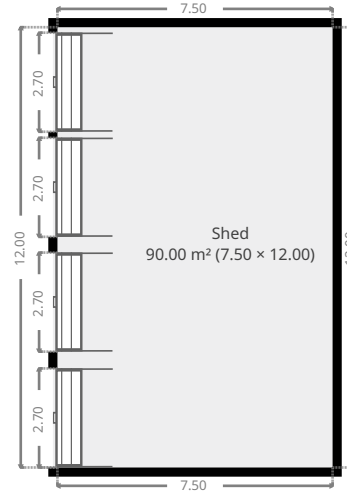
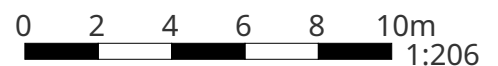

42 Schlenker Drive

Hall

Width: 2.57 m
 Length: 5.61 m
 Area: 7.71 m²
 Perimeter: 15.43 m

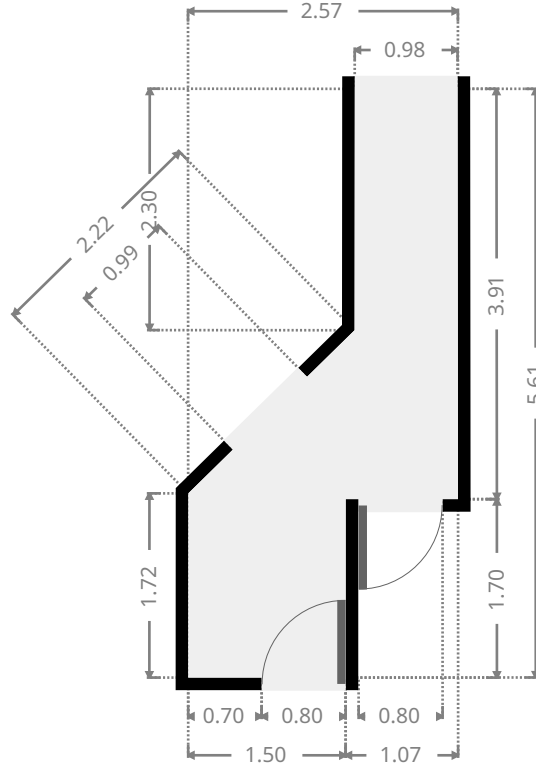
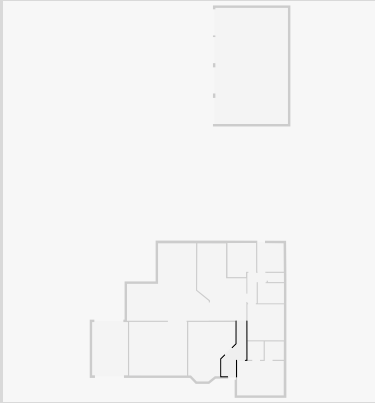

Living Room

Width: 4.89 m
 Length: 6.15 m
 Area: 24.24 m²
 Perimeter: 20.44 m

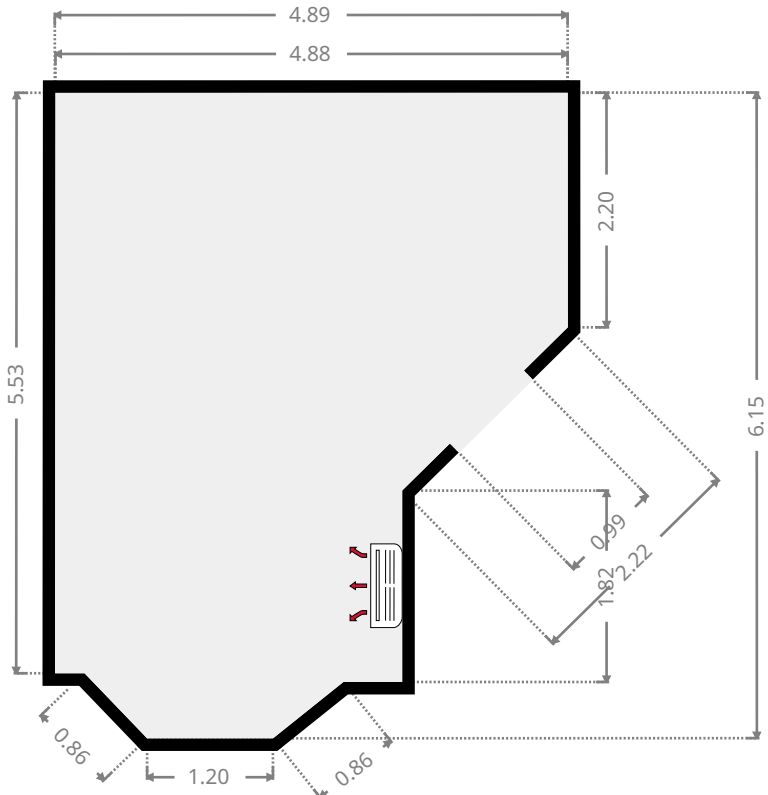
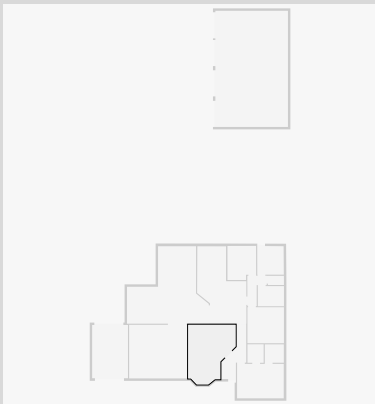

THIS FLOORPLAN IS PROVIDED WITHOUT WARRANTY OF ANY KIND. SENSOPIA DISCLAIMS ANY WARRANTY INCLUDING, WITHOUT LIMITATION, SATISFACTORY QUALITY OR ACCURACY OF DIMENSIONS.



42 Schlenker Drive

Master Bedroom

Width: 3.56 m
 Length: 4.82 m
 Area: 17.16 m²
 Perimeter: 16.76 m

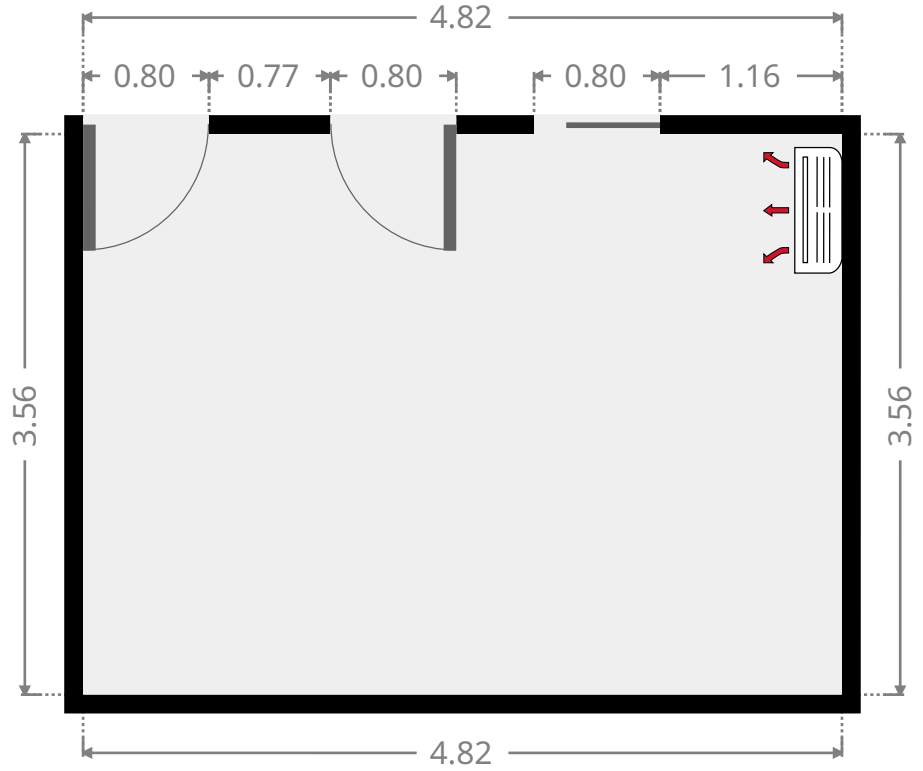
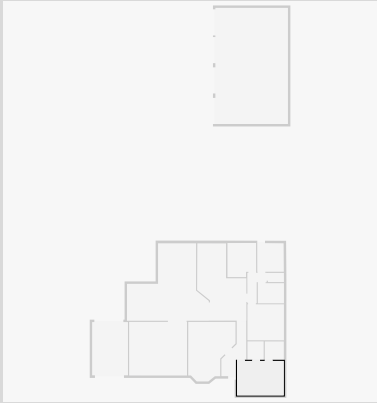

Closet

Width: 1.67 m
 Length: 1.91 m
 Area: 3.19 m²
 Perimeter: 7.16 m

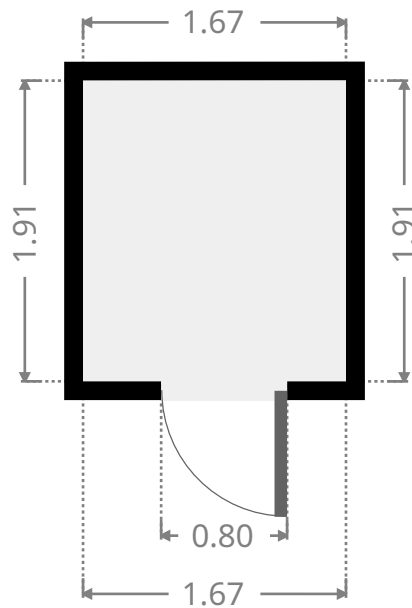
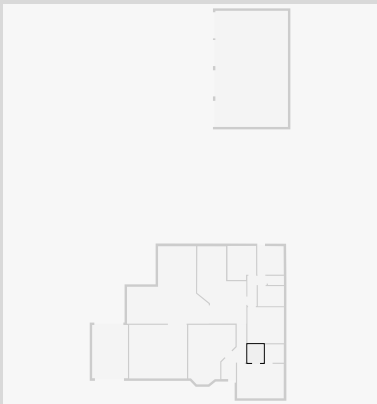

THIS FLOORPLAN IS PROVIDED WITHOUT WARRANTY OF ANY KIND. SENSOPIA DISCLAIMS ANY WARRANTY INCLUDING, WITHOUT LIMITATION, SATISFACTORY QUALITY OR ACCURACY OF DIMENSIONS.

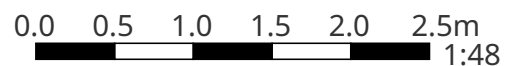

42 Schlenker Drive

Bathroom

Width: 1.90 m
Length: 1.97 m
Area: 3.73 m²
Perimeter: 7.73 m

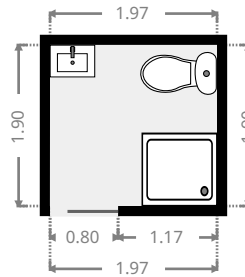
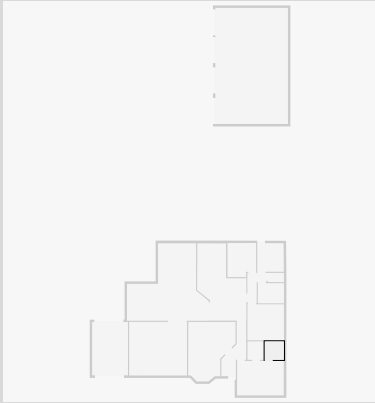

Kitchen

Width: 5.09 m
Length: 7.98 m
Area: 29.52 m²
Perimeter: 25.42 m

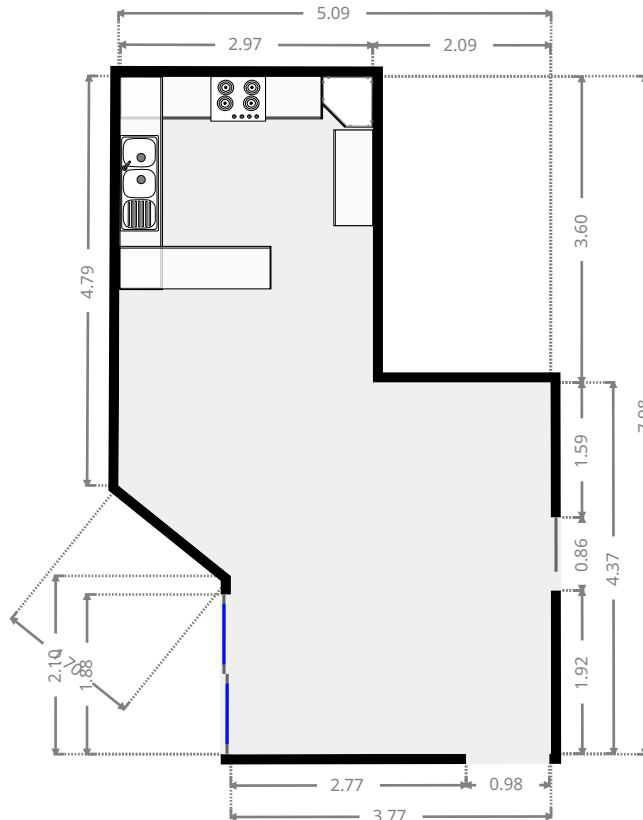
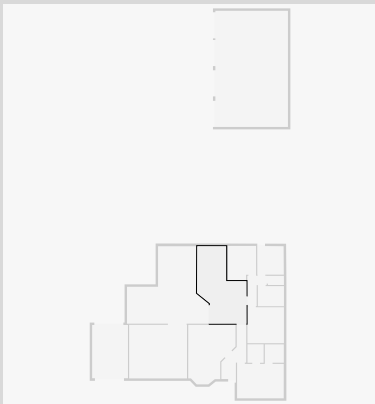

THIS FLOORPLAN IS PROVIDED WITHOUT WARRANTY OF ANY KIND. SENSOPIA DISCLAIMS ANY WARRANTY INCLUDING, WITHOUT LIMITATION, SATISFACTORY QUALITY OR ACCURACY OF DIMENSIONS.

42 Schlenker Drive

Hall

Width: 2.00 m
 Length: 3.14 m
 Area: 4.03 m²
 Perimeter: 10.28 m

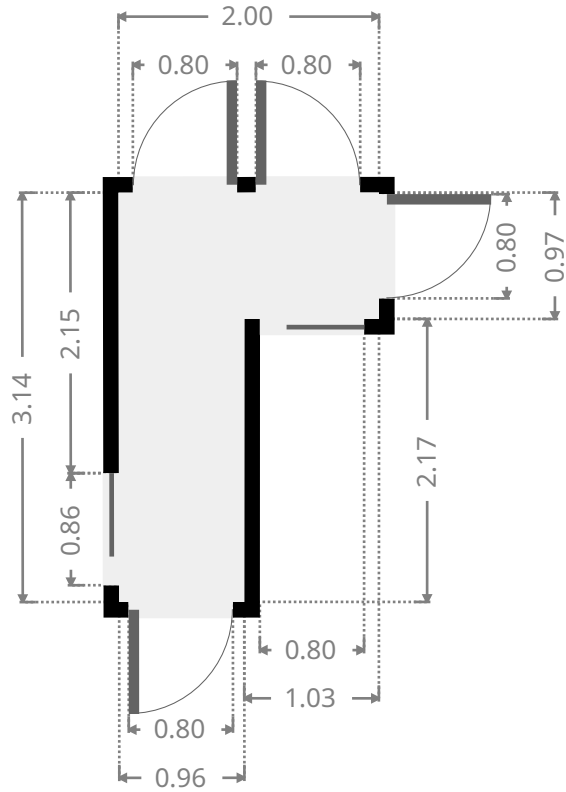
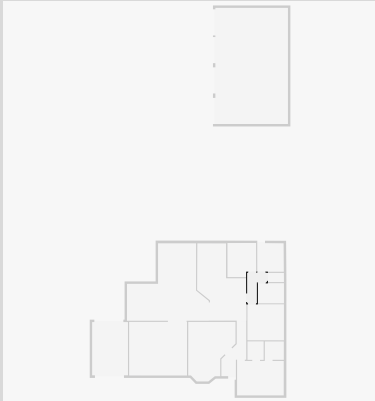

Bedroom

Width: 3.72 m
 Length: 3.77 m
 Area: 14.02 m²
 Perimeter: 14.98 m

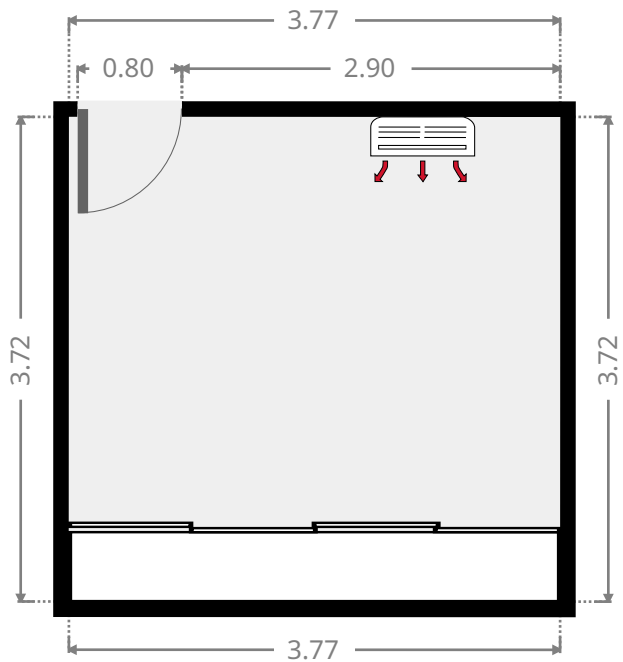
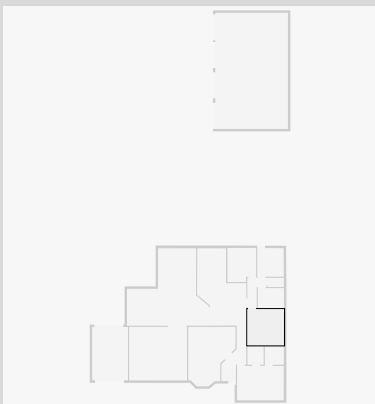

THIS FLOORPLAN IS PROVIDED WITHOUT WARRANTY OF ANY KIND. SENSOPIA DISCLAIMS ANY WARRANTY INCLUDING, WITHOUT LIMITATION, SATISFACTORY QUALITY OR ACCURACY OF DIMENSIONS.

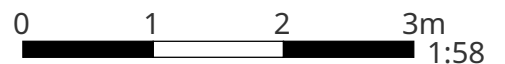

42 Schlenker Drive

Bedroom

Width: 2.97 m
Length: 3.53 m
Area: 9.87 m²
Perimeter: 12.97 m

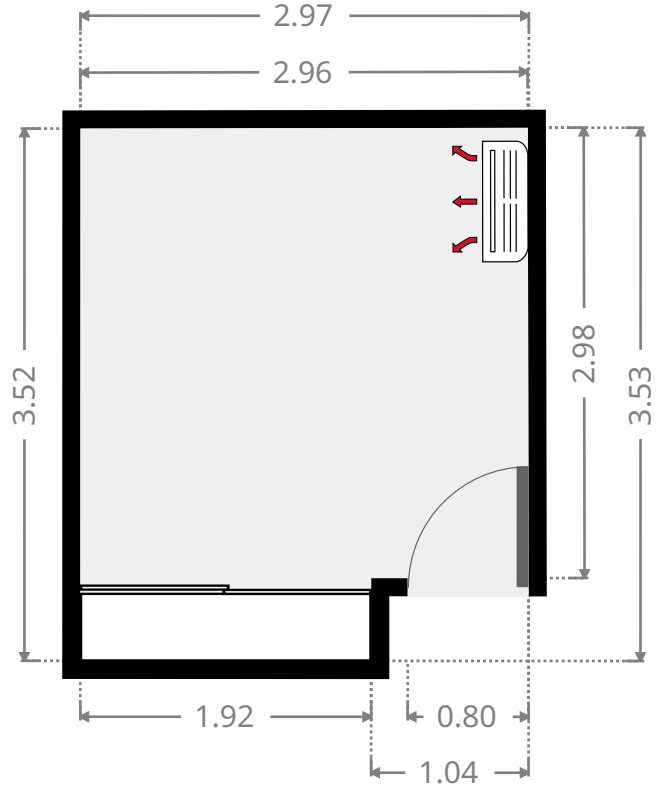
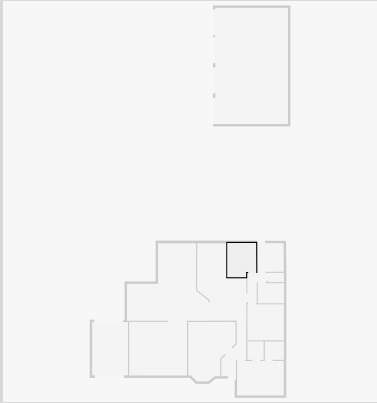

Bathroom

Width: 2.08 m
Length: 2.70 m
Area: 5.61 m²
Perimeter: 9.56 m

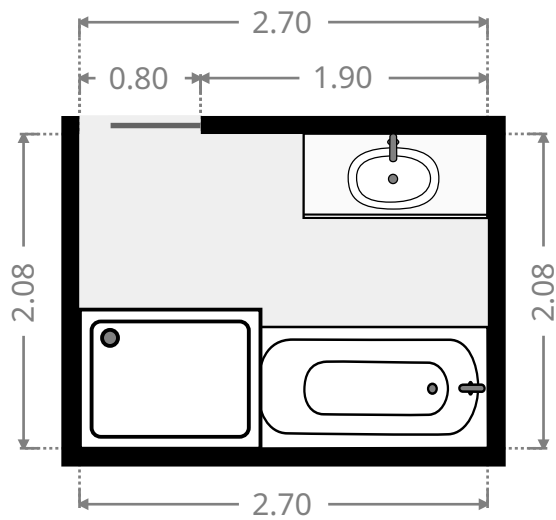
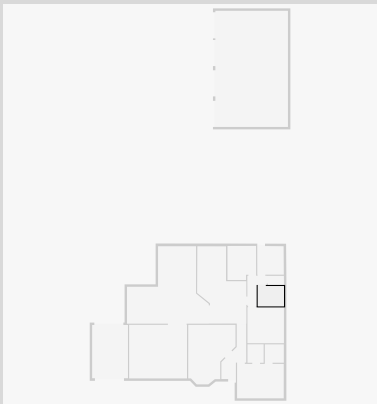

42 Schlenker Drive

Toilet / Half Bath

Width: 0.95 m
 Length: 1.66 m
 Area: 1.58 m²
 Perimeter: 5.22 m

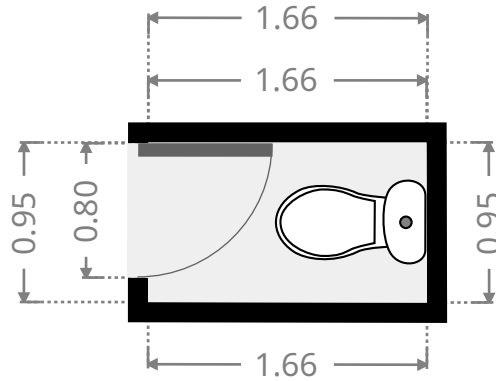
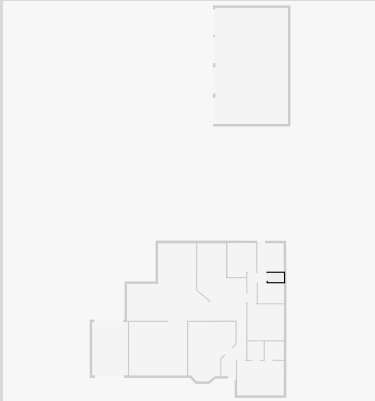

Laundry Room

Width: 2.74 m
 Length: 2.98 m
 Area: 8.06 m²
 Perimeter: 11.36 m

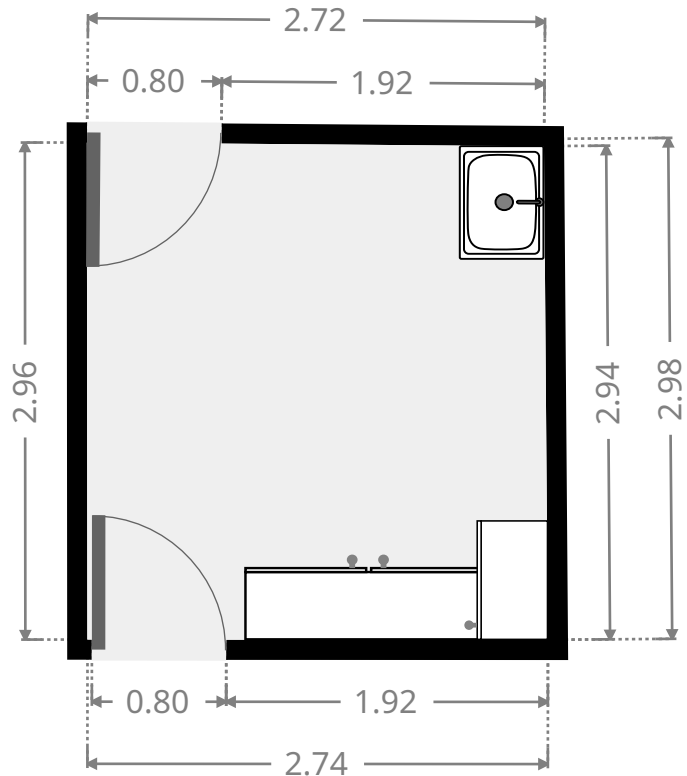
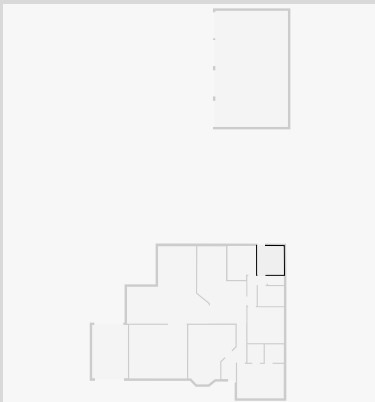

THIS FLOORPLAN IS PROVIDED WITHOUT WARRANTY OF ANY KIND. SENSOPIA DISCLAIMS ANY WARRANTY INCLUDING, WITHOUT LIMITATION, SATISFACTORY QUALITY OR ACCURACY OF DIMENSIONS.

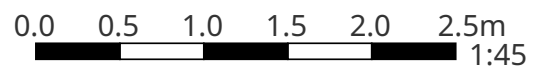

42 Schlenker Drive

Other

Width: 8.00 m
 Length: 8.45 m
 Area: 47.03 m²
 Perimeter: 32.21 m

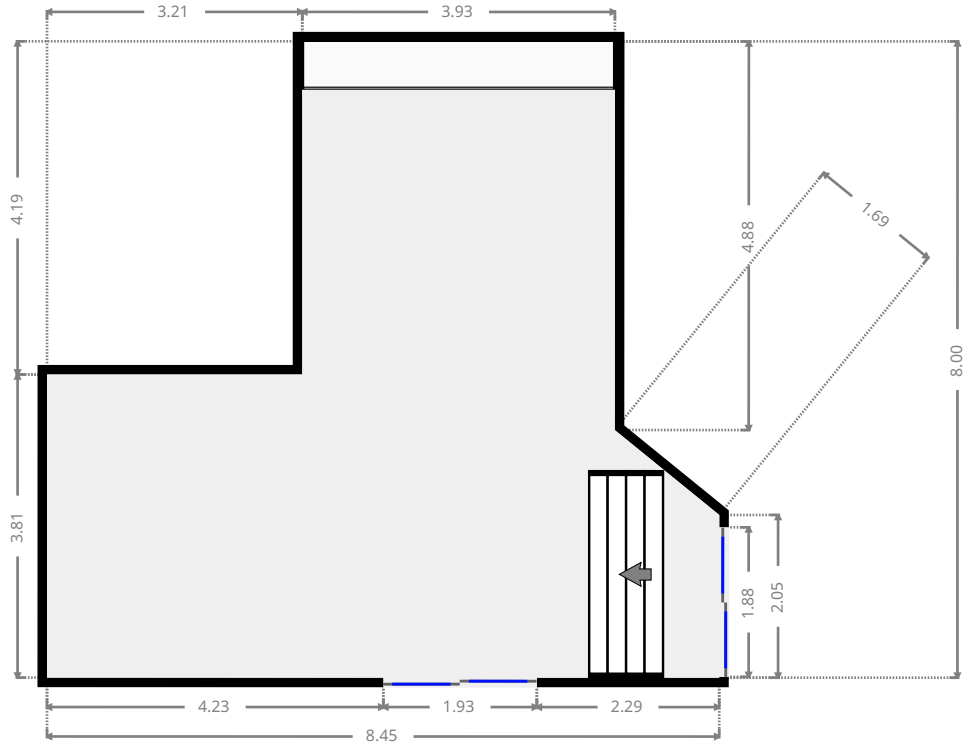
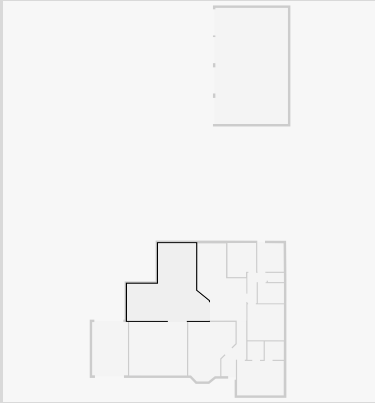

Living Room

Width: 5.54 m
 Length: 5.99 m
 Area: 33.14 m²
 Perimeter: 23.04 m

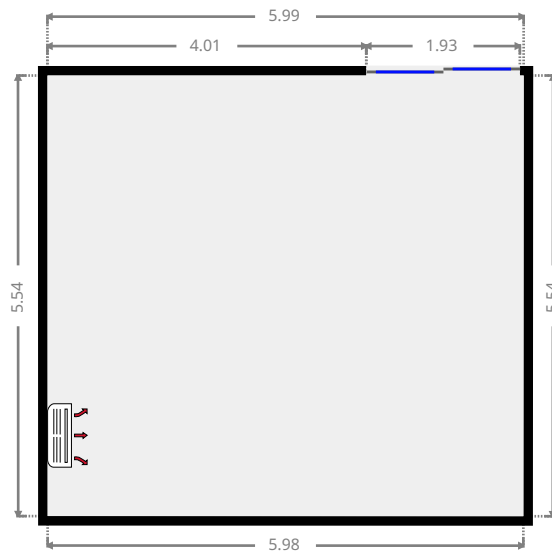
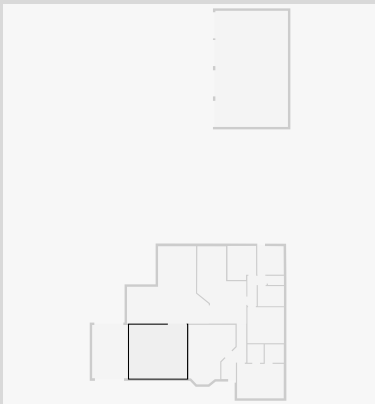

THIS FLOORPLAN IS PROVIDED WITHOUT WARRANTY OF ANY KIND. SENSOPIA DISCLAIMS ANY WARRANTY INCLUDING, WITHOUT LIMITATION, SATISFACTORY QUALITY OR ACCURACY OF DIMENSIONS.

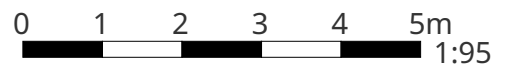

42 Schlenker Drive

Garage

Width: 3.70 m
Length: 5.50 m
Area: 20.35 m²
Perimeter: 18.40 m

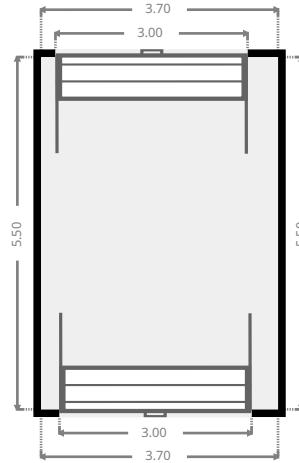
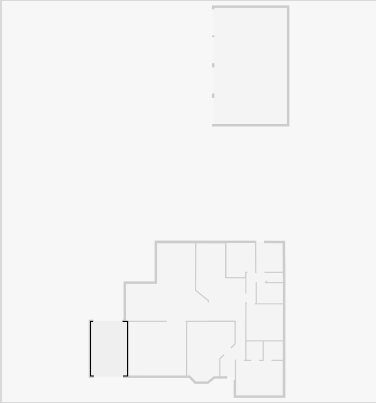

Shed

Width: 7.50 m
Length: 12.00 m
Area: 90.00 m²
Perimeter: 39.00 m

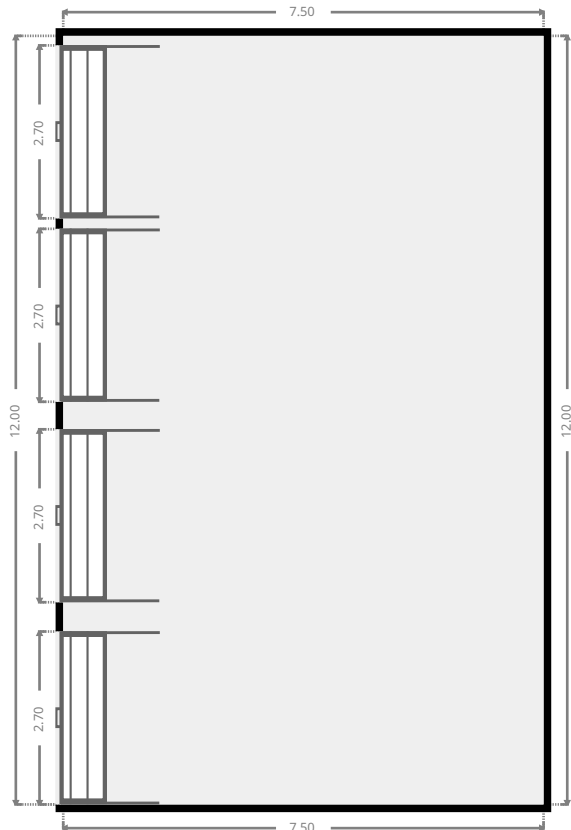
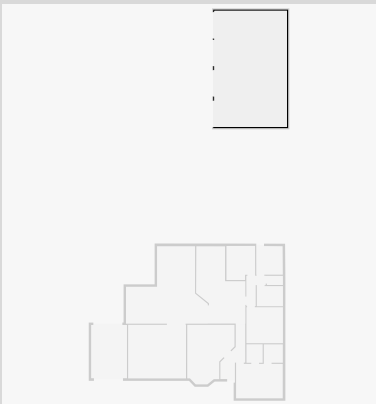

THIS FLOORPLAN IS PROVIDED WITHOUT WARRANTY OF ANY KIND. SENSOPIA DISCLAIMS ANY WARRANTY INCLUDING, WITHOUT LIMITATION, SATISFACTORY QUALITY OR ACCURACY OF DIMENSIONS.

