

42 Rosewood Drive

SUBMITTED BY
Ray White Rockhampton Casey
stockers@cqoz.com

CREATED ON
2022-04-26

Floors
2

▼ Ground Floor

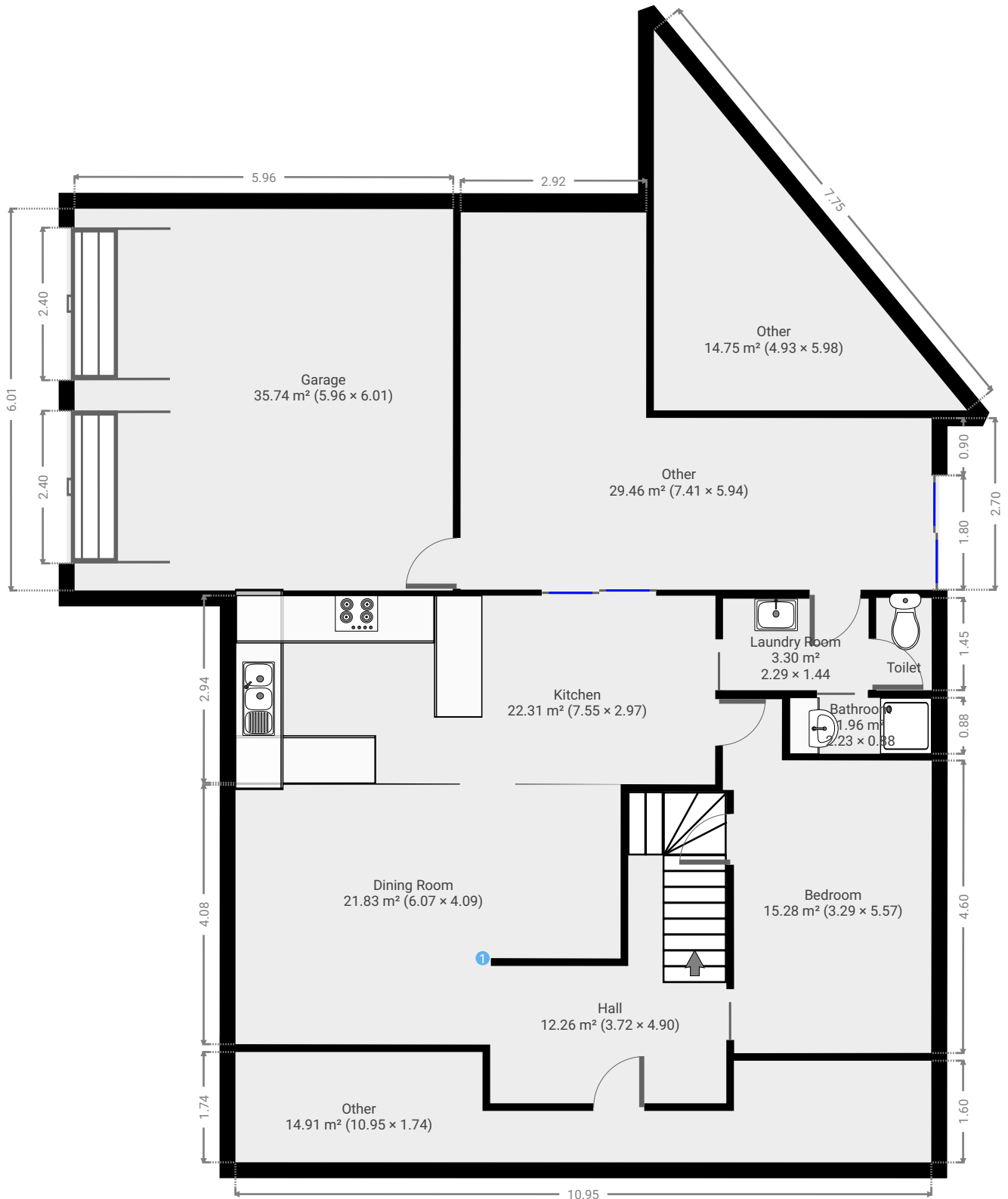

▼ Dining Room
Ground Floor

WIDTH: 6.07 m • LENGTH: 4.09 m
AREA: 21.83 m² • PERIMETER: 20.30 m

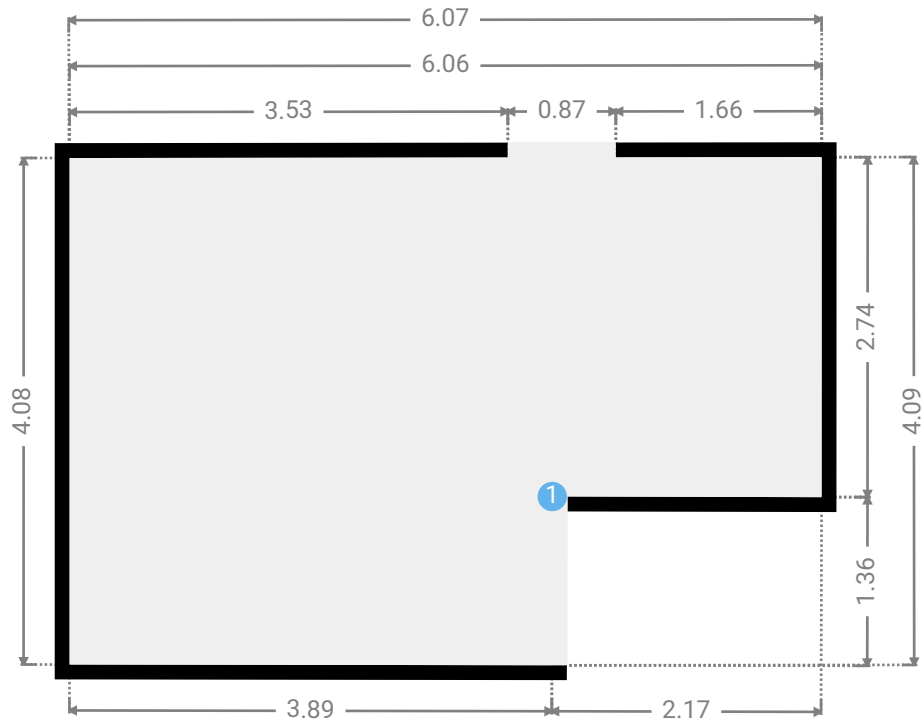
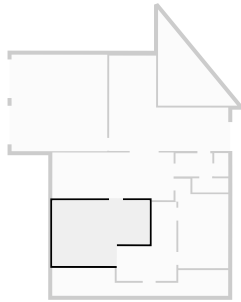

▼ Dining Room/Ground Floor

1 OPENING

Height
0.00 m



▼ **Hall**
Ground Floor

WIDTH: 3.72 m • LENGTH: 4.90 m
AREA: 12.26 m² • PERIMETER: 17.24 m

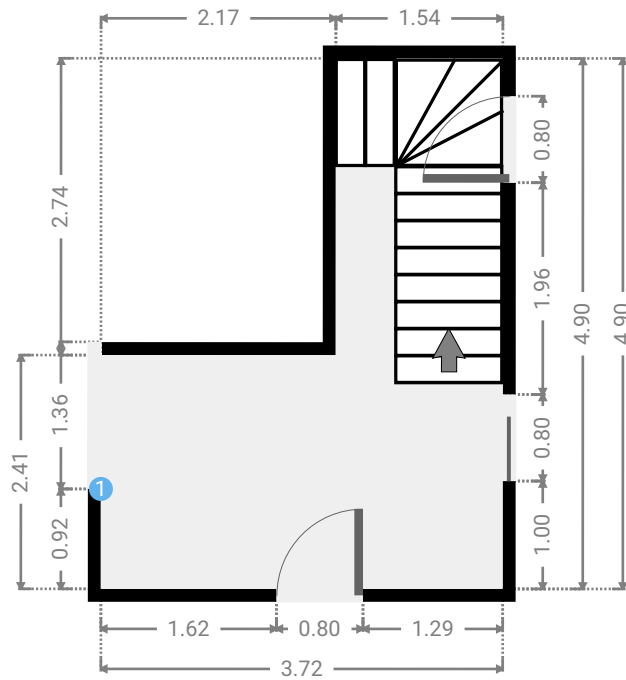
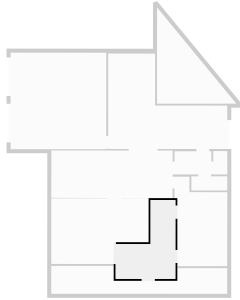

▼ **Bedroom**
Ground Floor

WIDTH: 3.29 m • LENGTH: 5.57 m
AREA: 15.28 m² • PERIMETER: 17.69 m

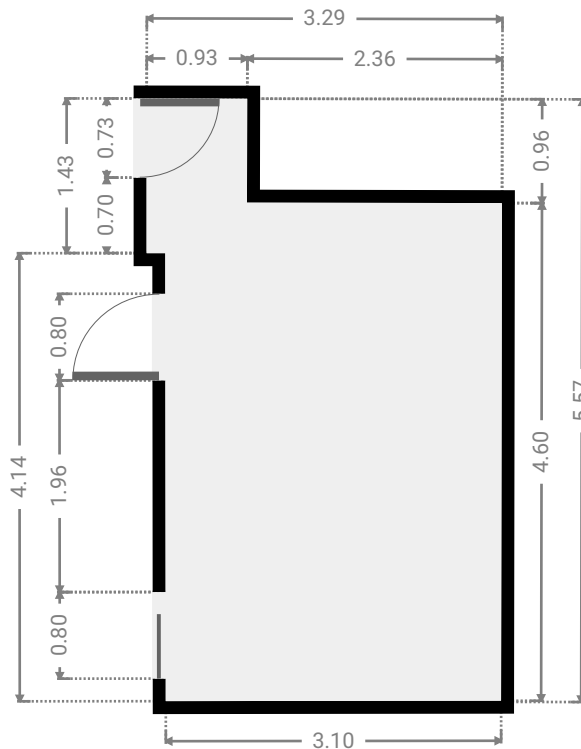
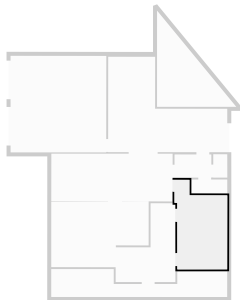

▼ **Kitchen**
Ground Floor

WIDTH: 7.55 m • LENGTH: 2.97 m
AREA: 22.31 m² • PERIMETER: 21.00 m

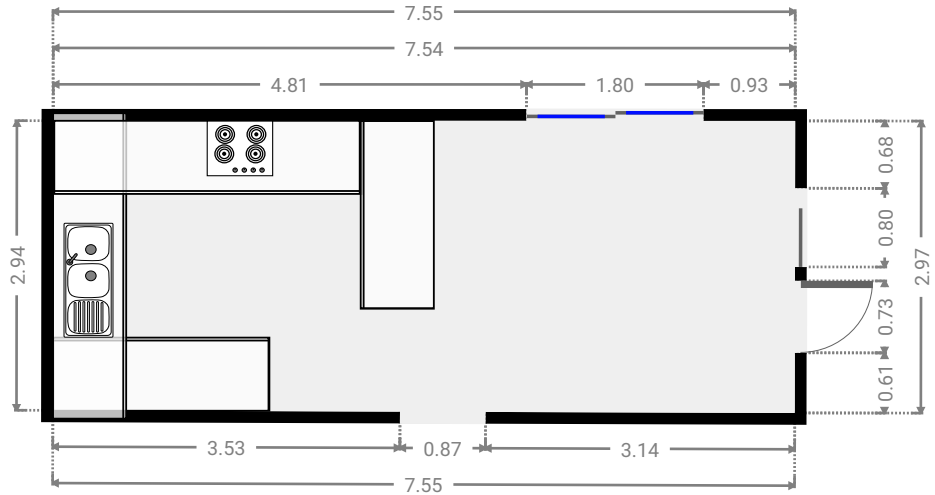
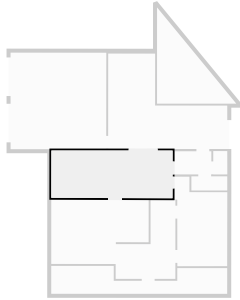

▼ **Laundry Room**
Ground Floor

WIDTH: 2.29 m • LENGTH: 1.44 m
AREA: 3.30 m² • PERIMETER: 7.46 m

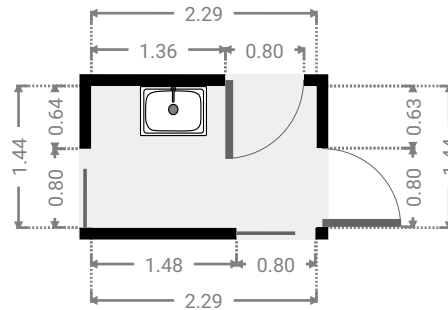
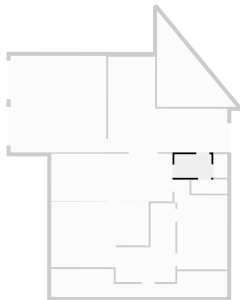

FLOORS: 2

▼ Bathroom
Ground Floor

WIDTH: 2.23 m • LENGTH: 0.88 m
AREA: 1.96 m² • PERIMETER: 6.22 m

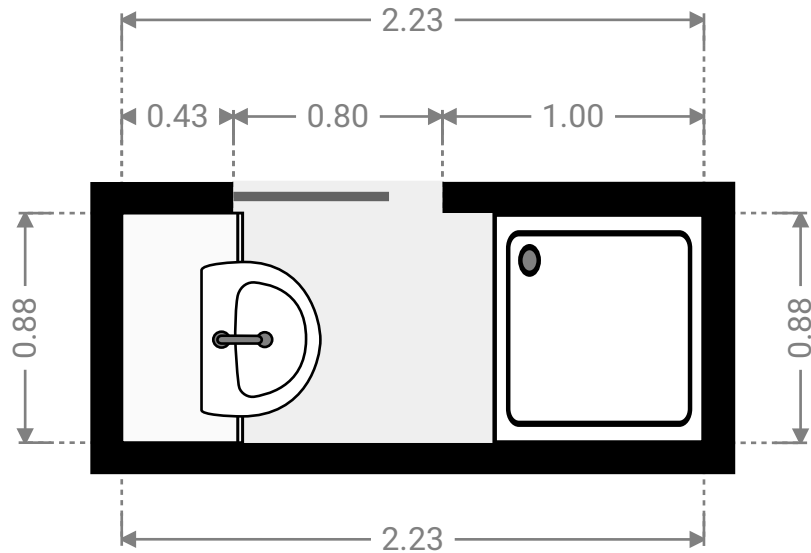
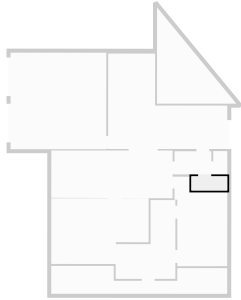

▼ Toilet
Ground Floor

WIDTH: 0.87 m • LENGTH: 1.46 m
AREA: 1.27 m² • PERIMETER: 4.65 m

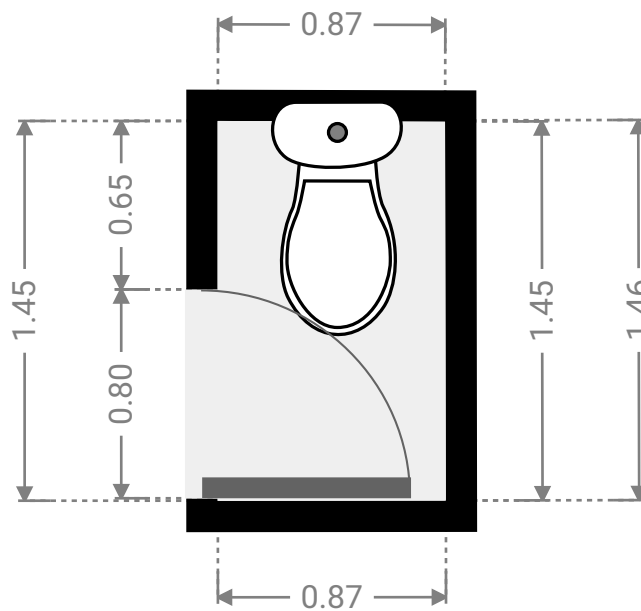
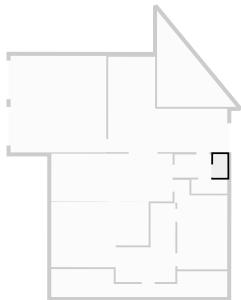

▼ Other
Ground Floor

WIDTH: 7.41 m • LENGTH: 5.94 m
AREA: 29.46 m² • PERIMETER: 26.69 m

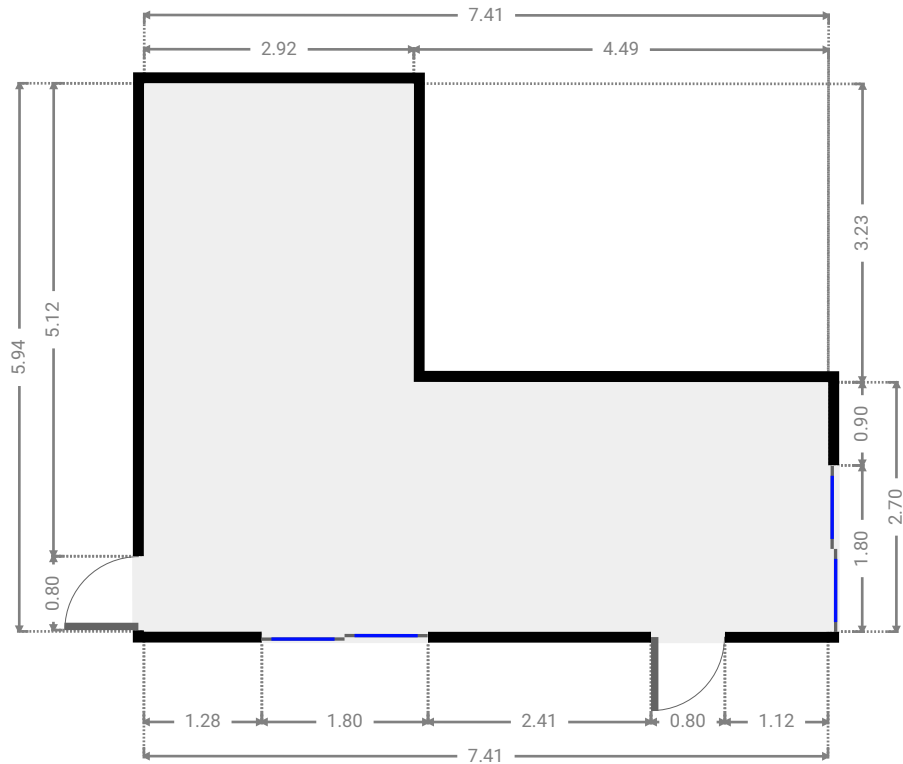
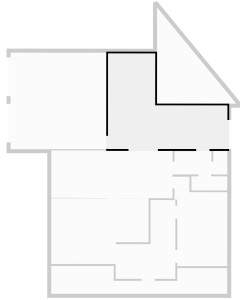

▼ Garage
Ground Floor

WIDTH: 5.96 m • LENGTH: 6.01 m
AREA: 35.74 m² • PERIMETER: 23.91 m

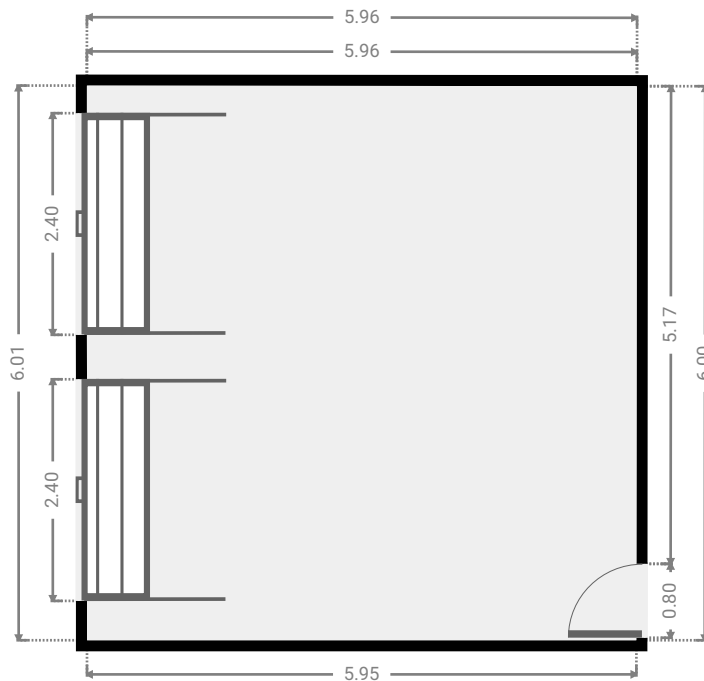
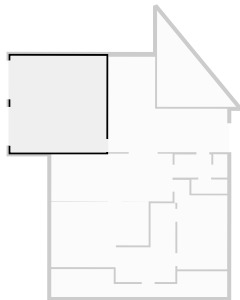

▼ **Other**
Ground Floor

WIDTH: 4.93 m • LENGTH: 5.98 m
AREA: 14.75 m² • PERIMETER: 18.67 m

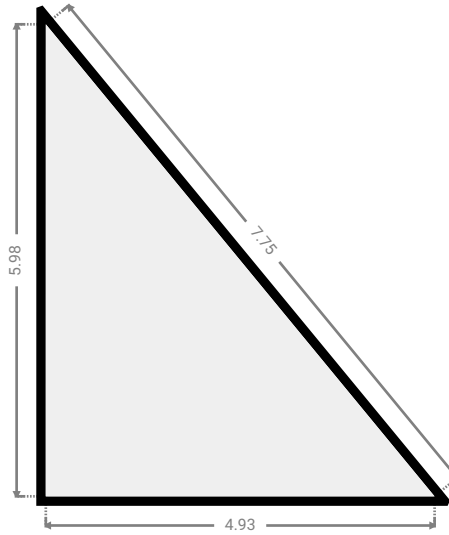
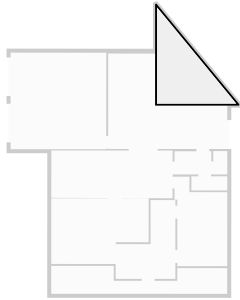

▼ **Other**
Ground Floor

WIDTH: 10.95 m • LENGTH: 1.74 m
AREA: 14.91 m² • PERIMETER: 26.95 m

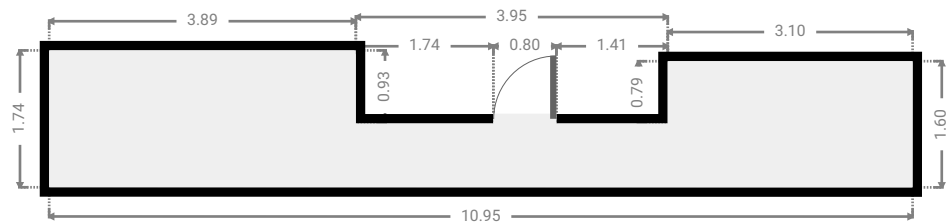
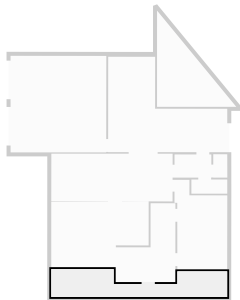

▼ 1st Floor

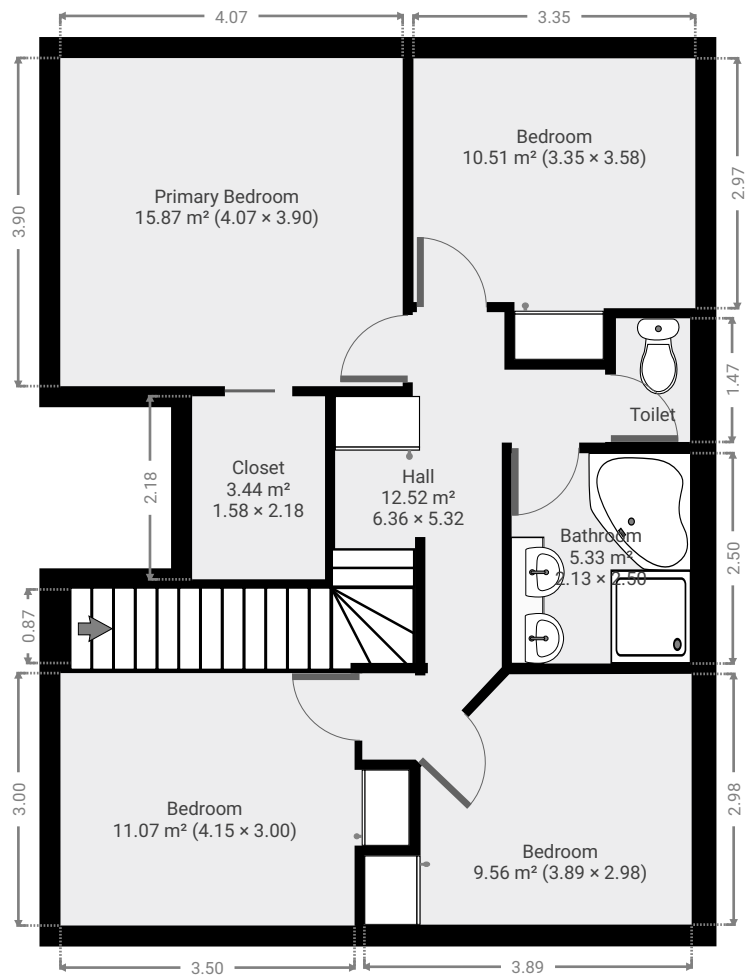

▼ **Bedroom**
1st Floor

WIDTH: 3.00 m • LENGTH: 4.15 m
AREA: 11.07 m² • PERIMETER: 14.29 m

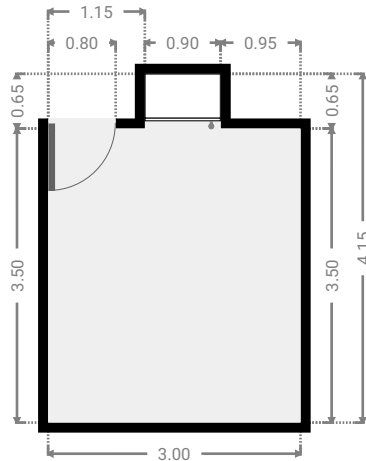
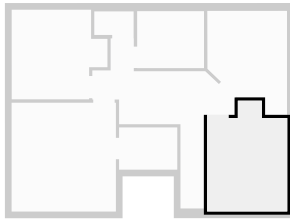

▼ **Hall**
1st Floor

WIDTH: 5.32 m • LENGTH: 6.36 m
AREA: 12.52 m² • PERIMETER: 22.74 m

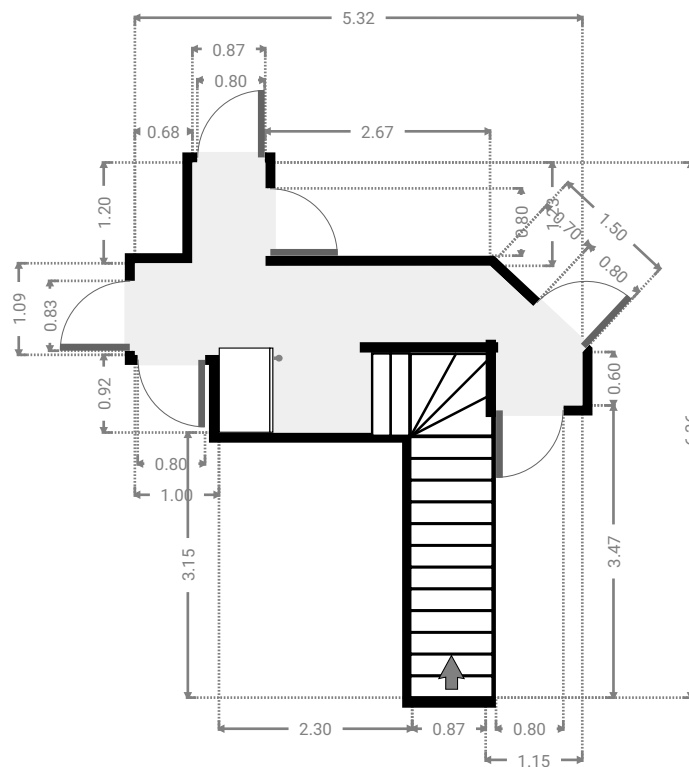
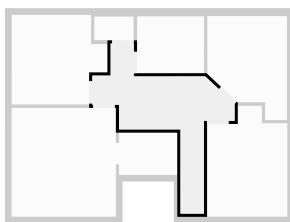

▼ **Bedroom**
1st Floor

WIDTH: 2.98 m • LENGTH: 3.89 m
AREA: 9.56 m² • PERIMETER: 13.10 m

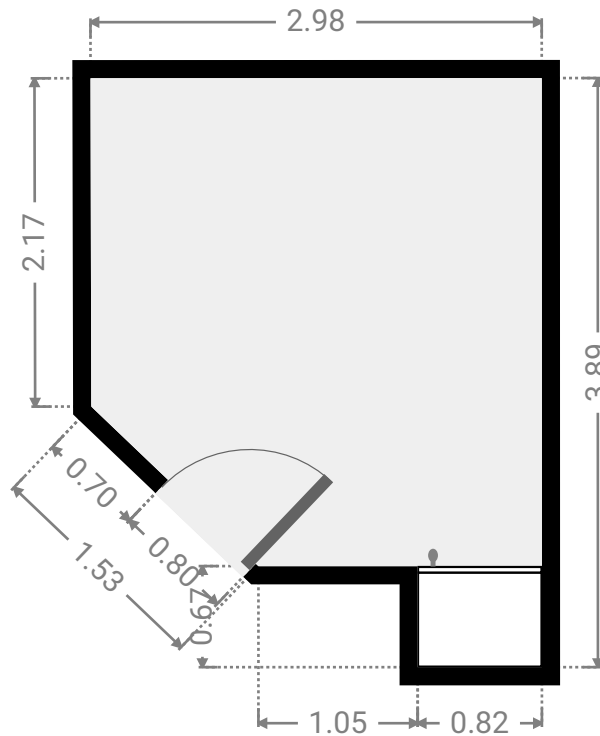
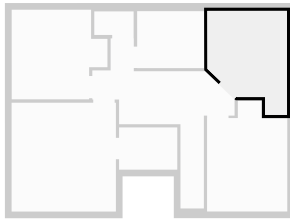

▼ **Bathroom**
1st Floor

WIDTH: 2.50 m • LENGTH: 2.13 m
AREA: 5.33 m² • PERIMETER: 9.26 m

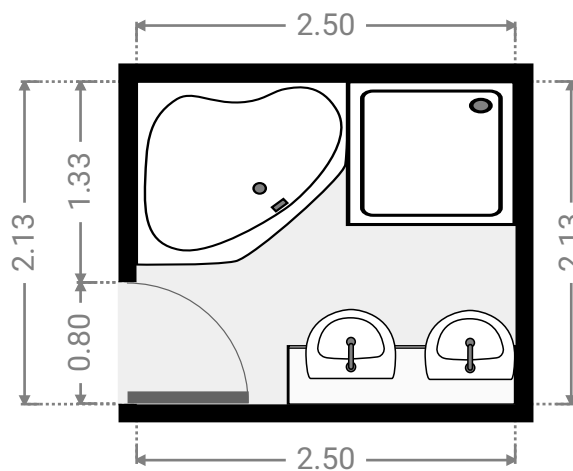
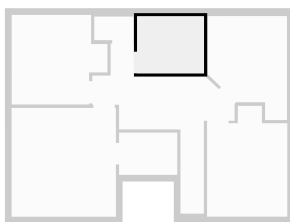

FLOORS: 2

▼ **Toilet**
1st Floor

WIDTH: 1.47 m • LENGTH: 0.88 m
AREA: 1.29 m² • PERIMETER: 4.70 m

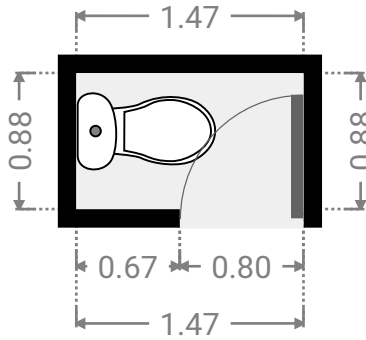
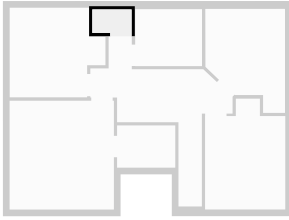

▼ **Bedroom**
1st Floor

WIDTH: 3.58 m • LENGTH: 3.35 m
AREA: 10.51 m² • PERIMETER: 13.86 m

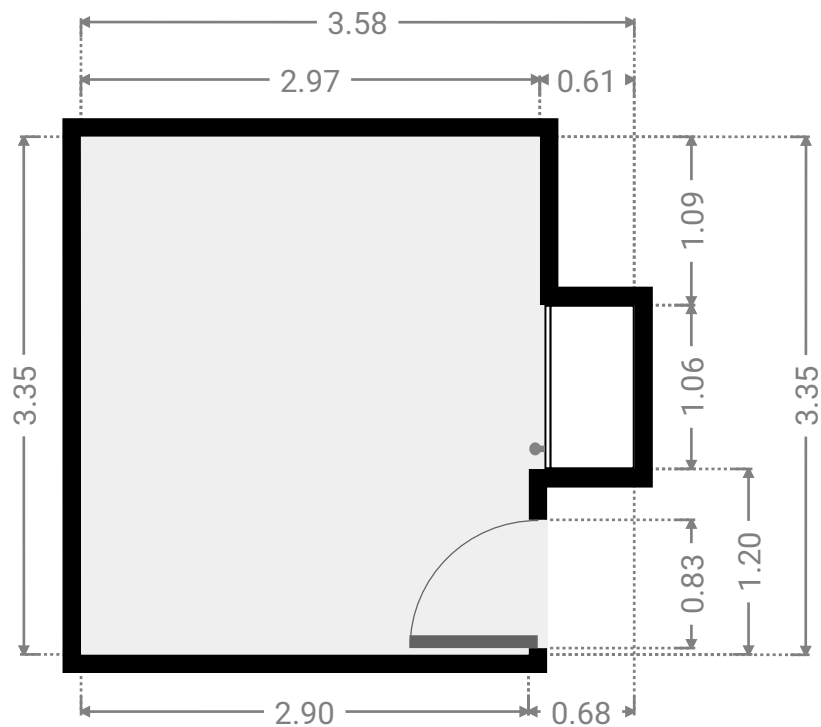
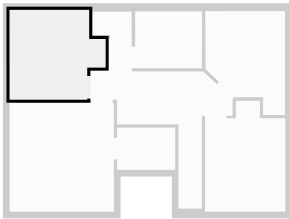

▼ **Primary Bedroom**
1st Floor

WIDTH: 3.90 m • LENGTH: 4.07 m
AREA: 15.87 m² • PERIMETER: 15.94 m

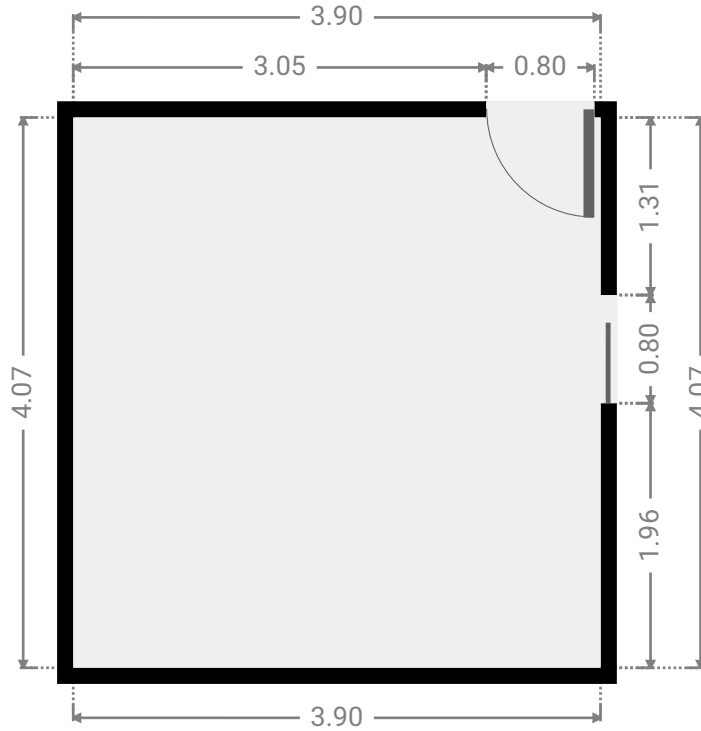
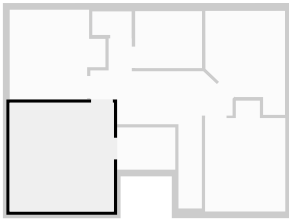

▼ **Closet**
1st Floor

WIDTH: 2.18 m • LENGTH: 1.58 m
AREA: 3.44 m² • PERIMETER: 7.51 m

