

# 42 Rose Street

Created on  
2020-11-24

Floors  
1

▼ 1st Floor



FLOORS:1

▼ Hall  
1st Floor

WIDTH:1.80 m · LENGTH:2.43 m  
AREA:4.37 m<sup>2</sup> · PERIMETER:8.46 m

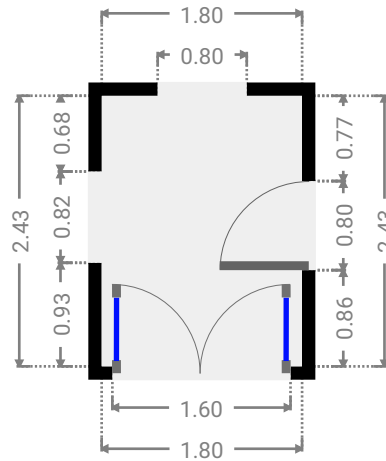
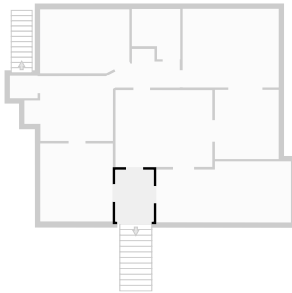

▼ Other  
1st Floor

WIDTH:6.33 m · LENGTH:2.87 m  
AREA:17.05 m<sup>2</sup> · PERIMETER:18.38 m

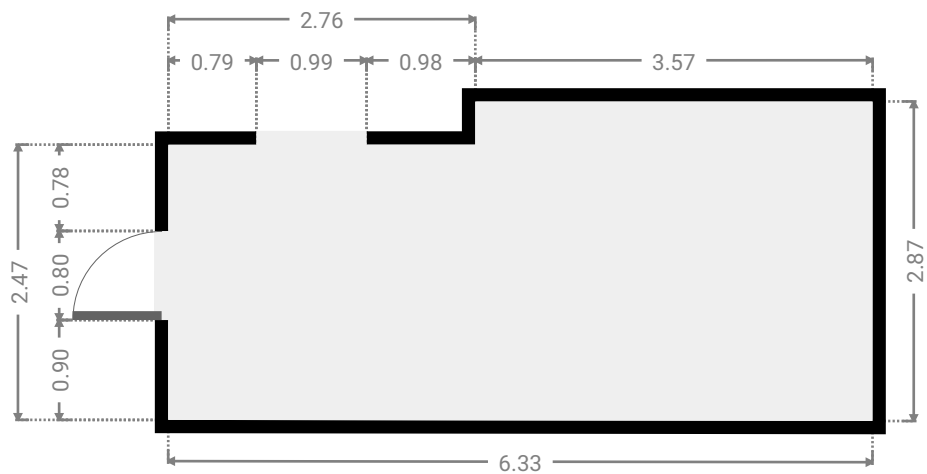
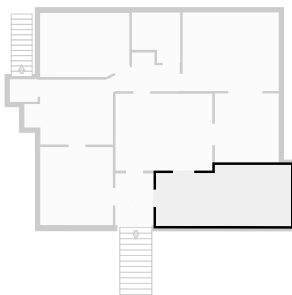

▼ Living Room  
1st Floor

WIDTH:4.54 m · LENGTH:3.60 m  
AREA:16.36 m<sup>2</sup> · PERIMETER:16.29 m

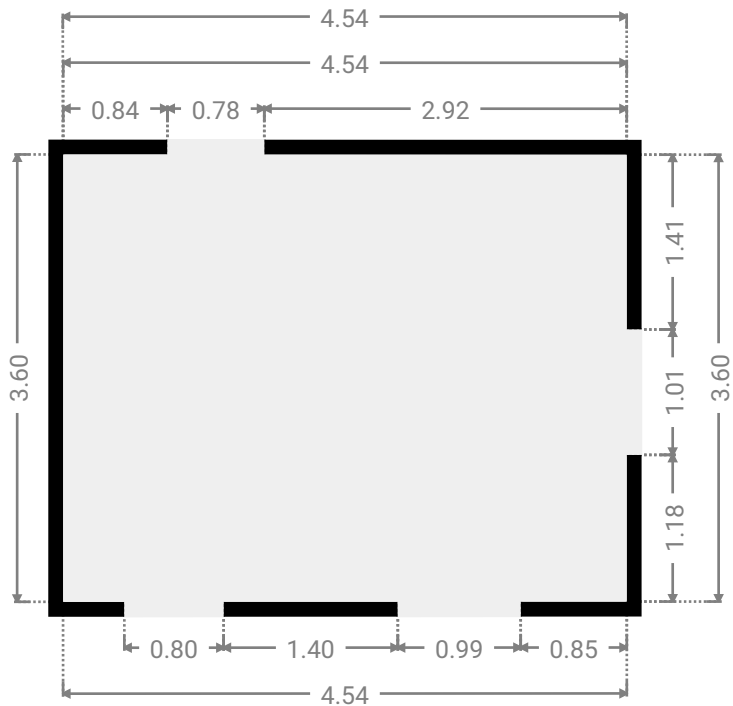
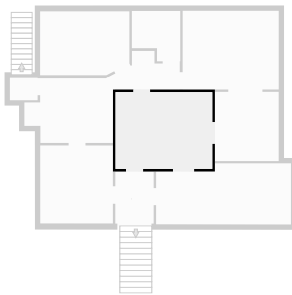

▼ Other  
1st Floor

WIDTH:2.99 m · LENGTH:3.25 m  
AREA:9.72 m<sup>2</sup> · PERIMETER:12.48 m

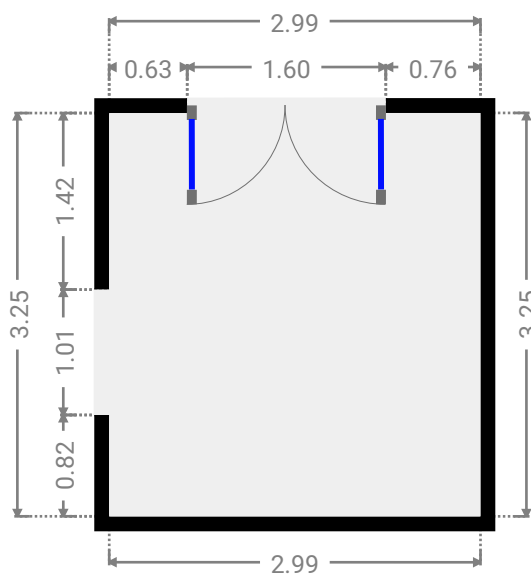
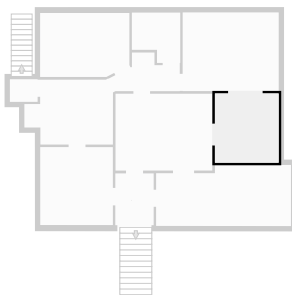

▼ Hall  
1st Floor

WIDTH:3.35 m · LENGTH:1.81 m  
AREA:4.22 m<sup>2</sup> · PERIMETER:9.67 m

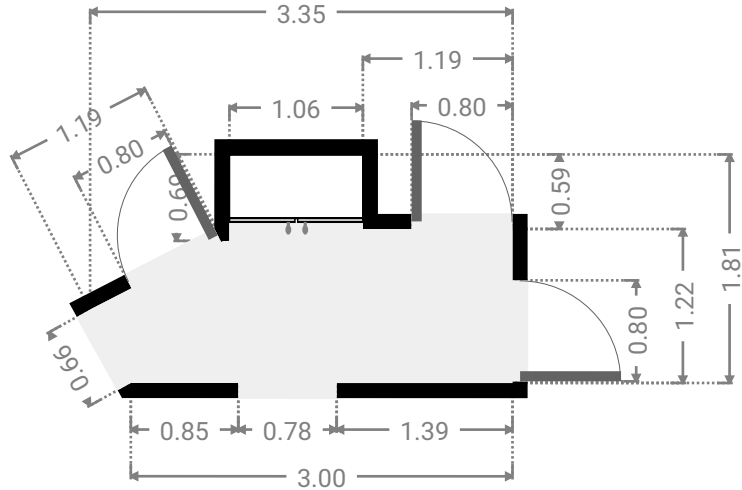
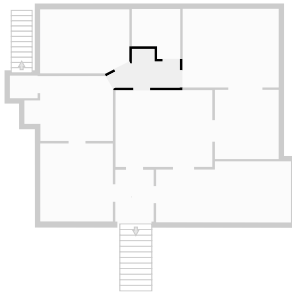

▼ Bedroom  
1st Floor

WIDTH:4.51 m · LENGTH:3.69 m  
AREA:16.63 m<sup>2</sup> · PERIMETER:16.39 m

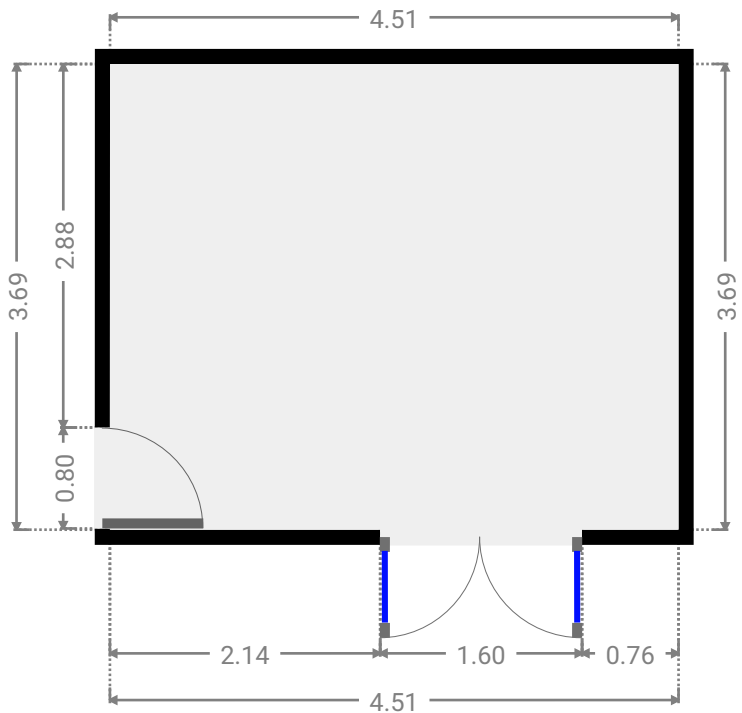
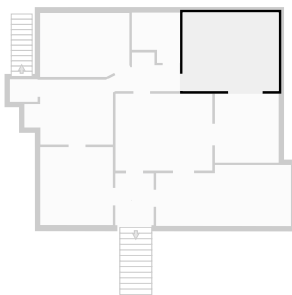

FLOORS:1

▼ **Bathroom**  
1st Floor

WIDTH:2.27 m · LENGTH:2.36 m  
AREA:4.63 m<sup>2</sup> · PERIMETER:9.26 m

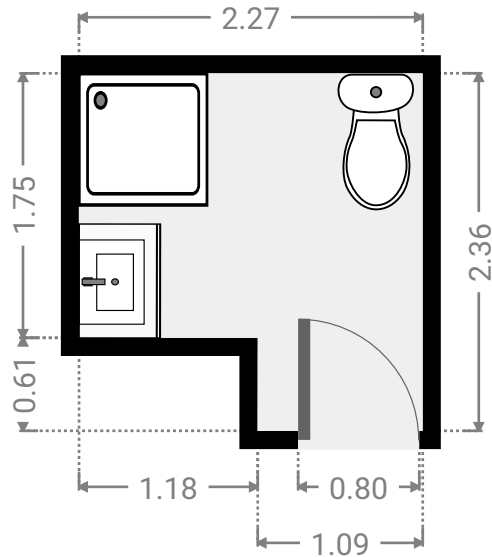
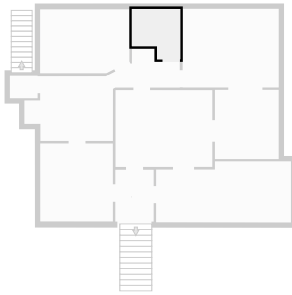

▼ **Bedroom**  
1st Floor

WIDTH:4.19 m · LENGTH:3.00 m  
AREA:12.26 m<sup>2</sup> · PERIMETER:13.95 m

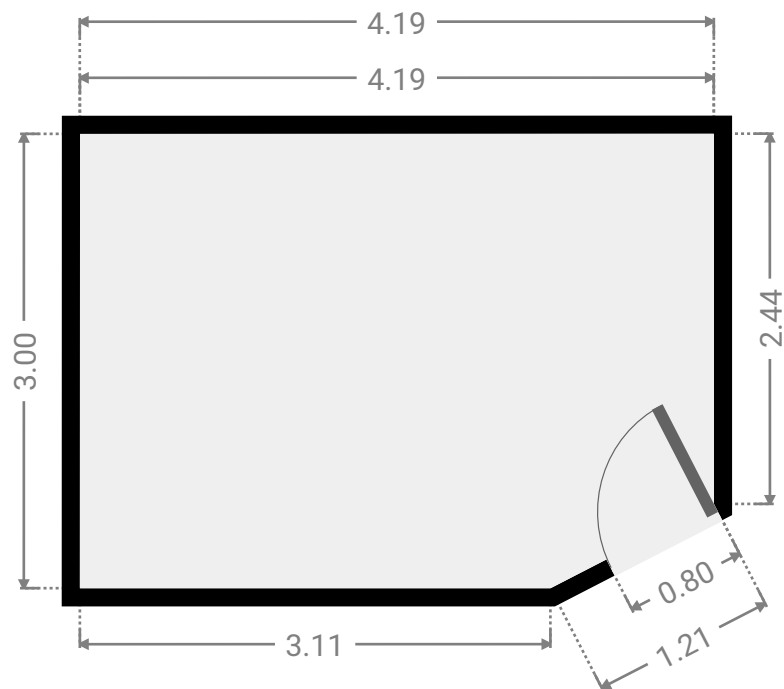
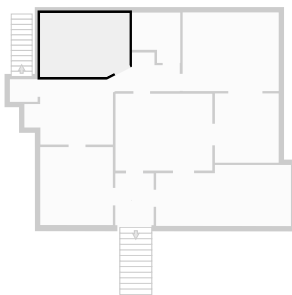

▼ Kitchen  
1st Floor

WIDTH:4.15 m · LENGTH:3.05 m  
AREA:11.09 m<sup>2</sup> · PERIMETER:14.14 m

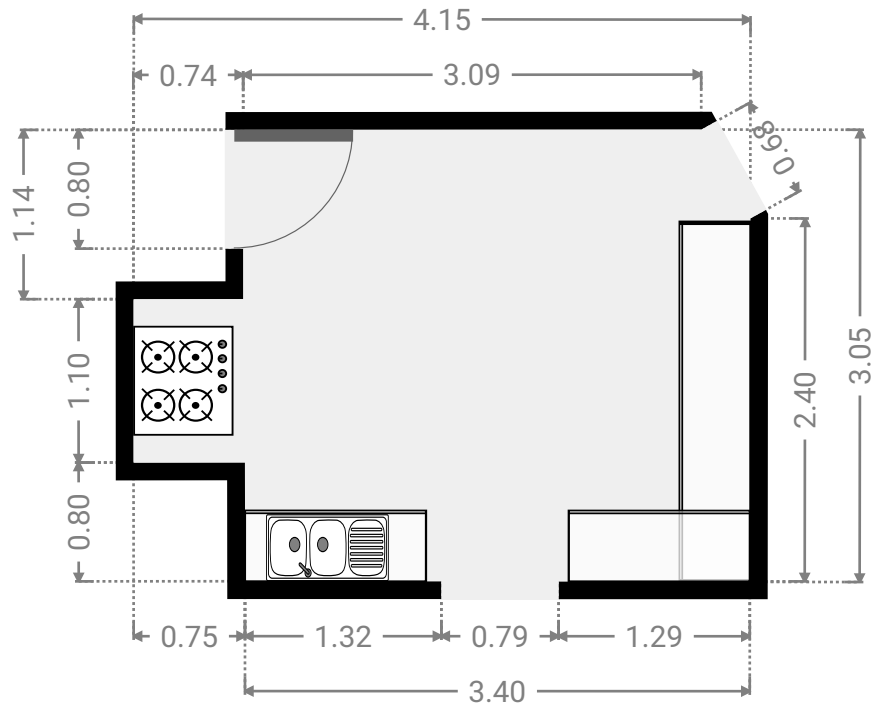
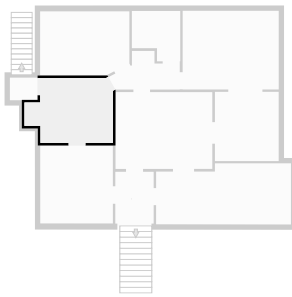

▼ Hall  
1st Floor

WIDTH:1.30 m · LENGTH:1.06 m  
AREA:1.38 m<sup>2</sup> · PERIMETER:4.72 m

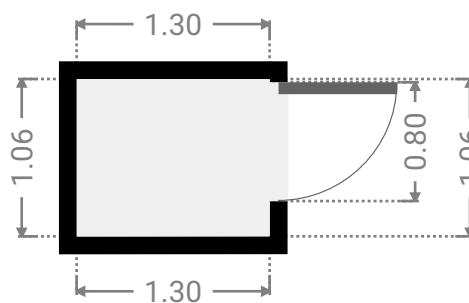
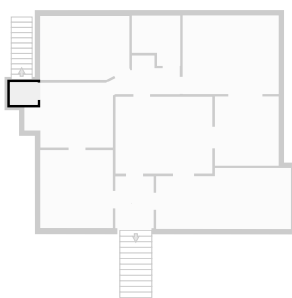

▼ Dining Room  
1st Floor

WIDTH:3.41 m · LENGTH:3.66 m  
AREA:12.45 m<sup>2</sup> · PERIMETER:14.12 m

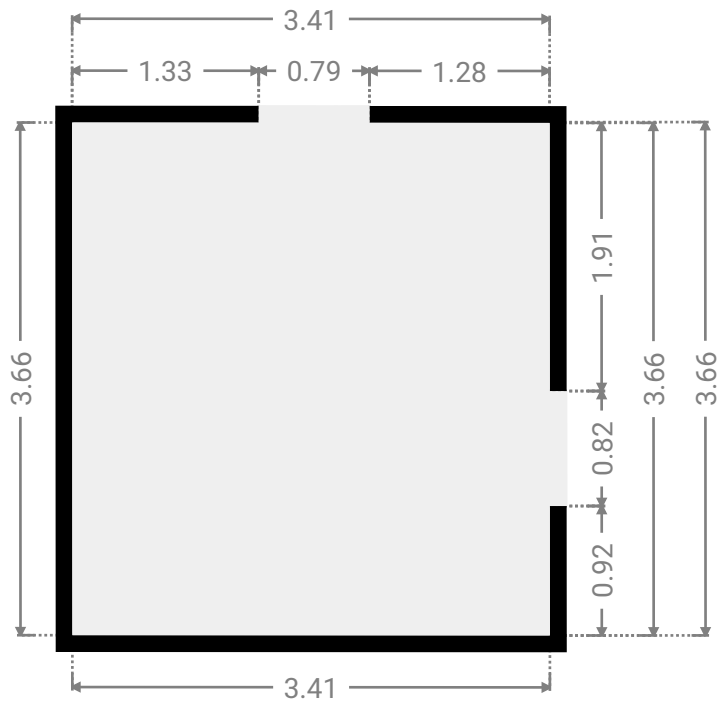
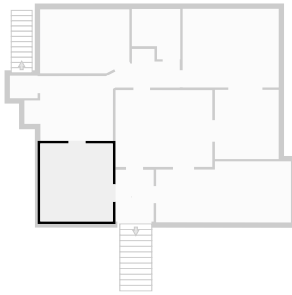



# 42 Rose Street, Ground

Created on  
2020-11-24

Floors 1
-------------

▼ Ground Floor

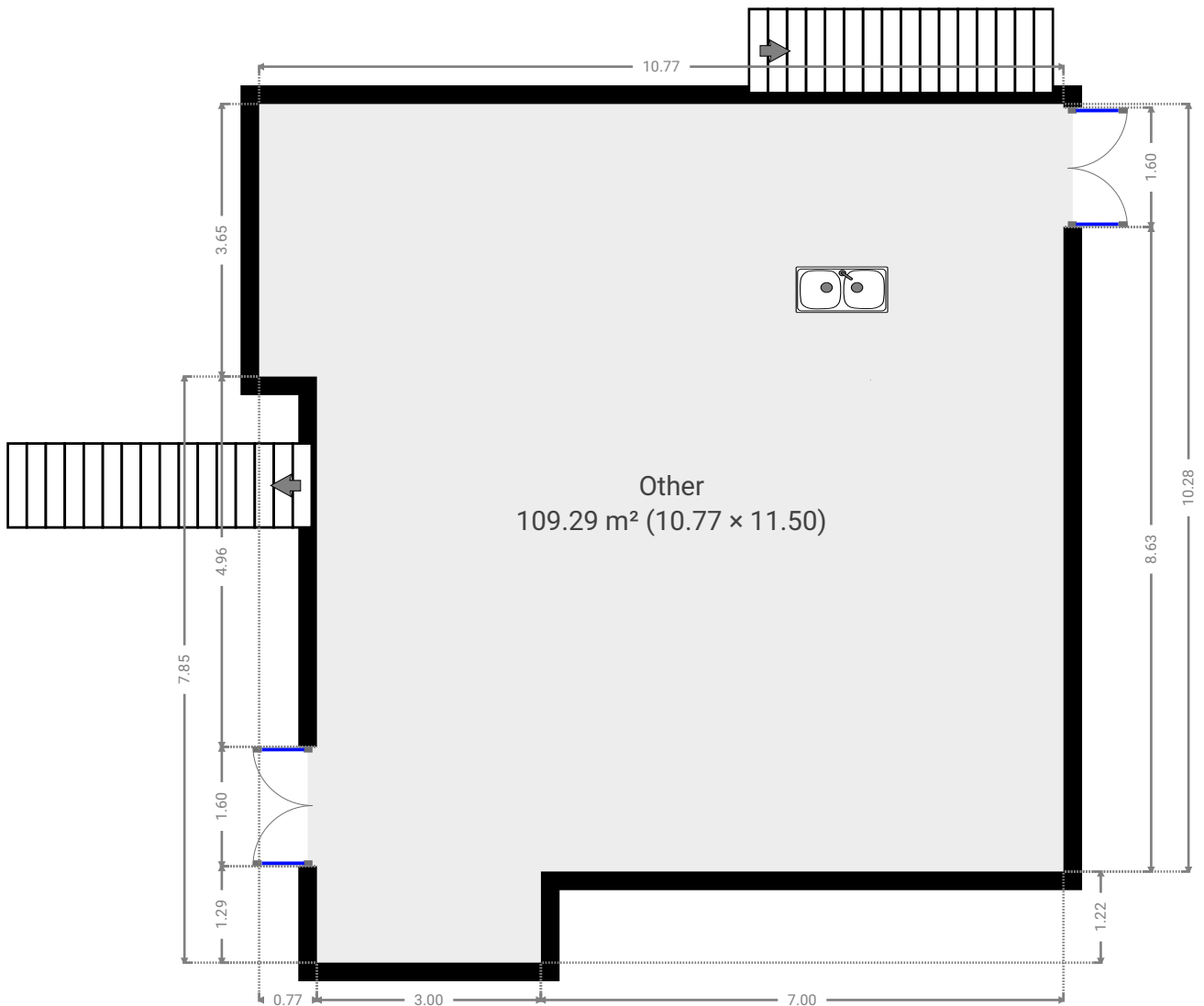
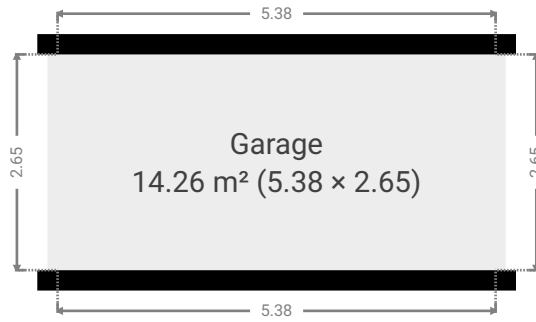

FLOORS:1

▼ Other  
Ground Floor

WIDTH:11.50 m · LENGTH:10.77 m  
AREA:109.29 m<sup>2</sup> · PERIMETER:44.55 m

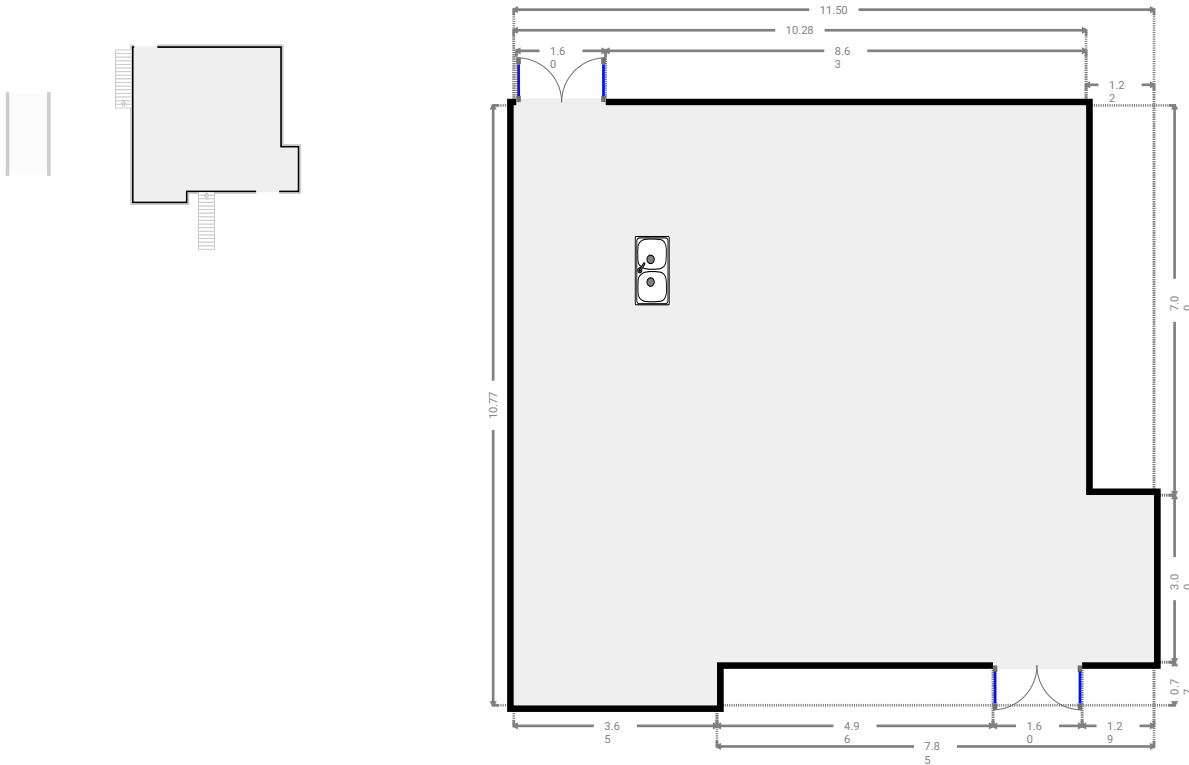

▼ Garage  
Ground Floor

WIDTH:2.65 m · LENGTH:5.38 m  
AREA:14.26 m<sup>2</sup> · PERIMETER:16.06 m

