

# 42 Lauga street

**SUBMITTED BY**

Ray White Rockhampton Casey  
stockers@cqoz.com

---

**CREATED ON**

2022-04-19

---

**Floors**

2

---

▼ Ground Floor

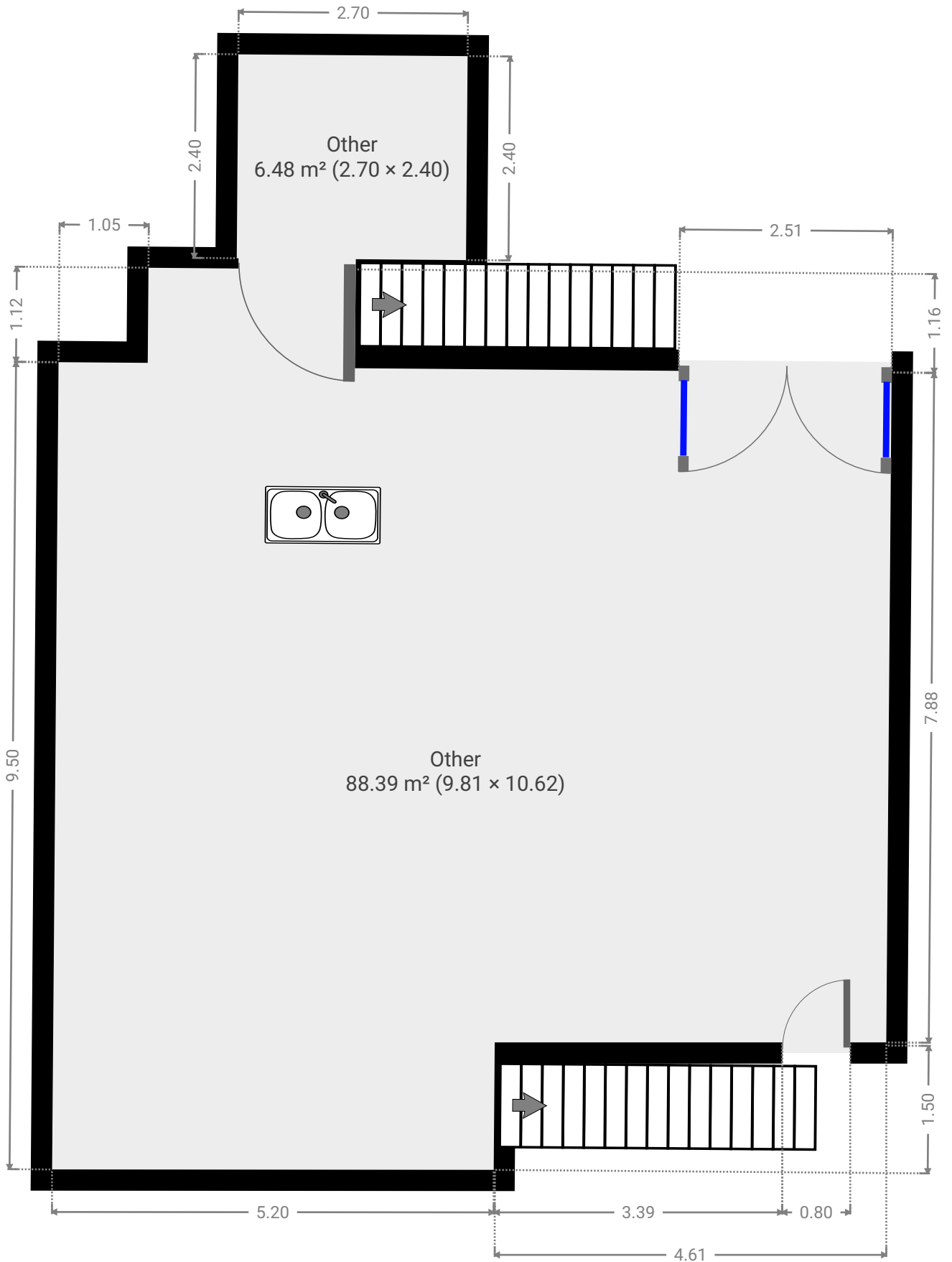

▼ Other  
Ground Floor

WIDTH: 9.81 m • LENGTH: 10.62 m  
AREA: 88.39 m<sup>2</sup> • PERIMETER: 40.79 m

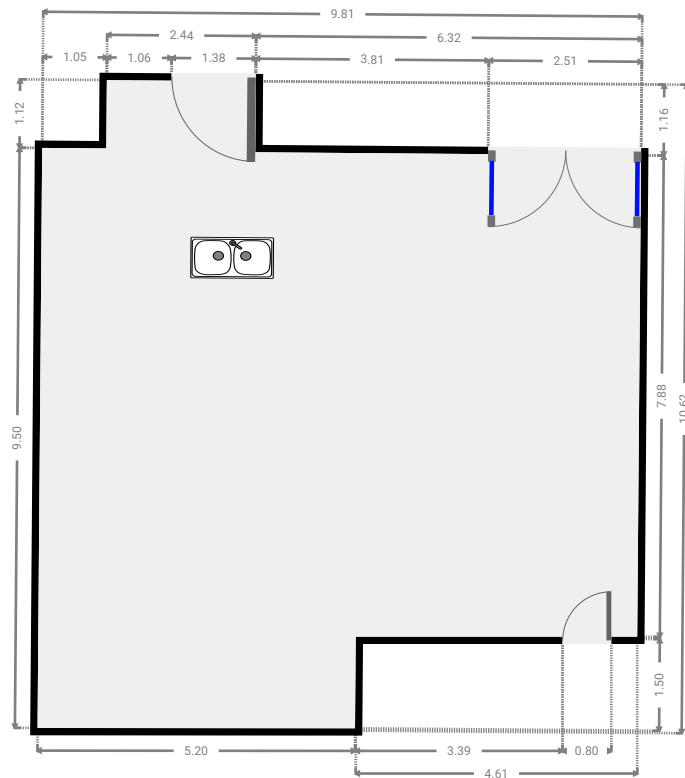
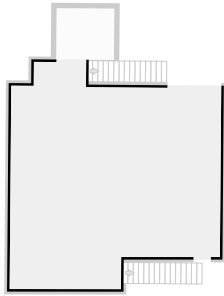

▼ Other  
Ground Floor

WIDTH: 2.70 m • LENGTH: 2.40 m  
AREA: 6.48 m<sup>2</sup> • PERIMETER: 10.20 m

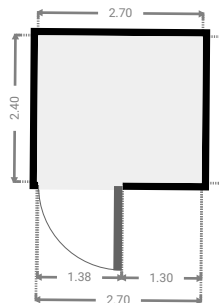
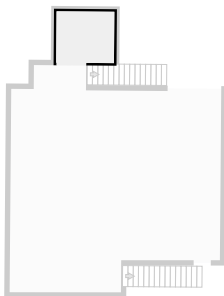

▼ 1st Floor



▼ Living Room  
1st Floor

WIDTH: 3.58 m • LENGTH: 3.80 m  
AREA: 13.58 m<sup>2</sup> • PERIMETER: 14.75 m

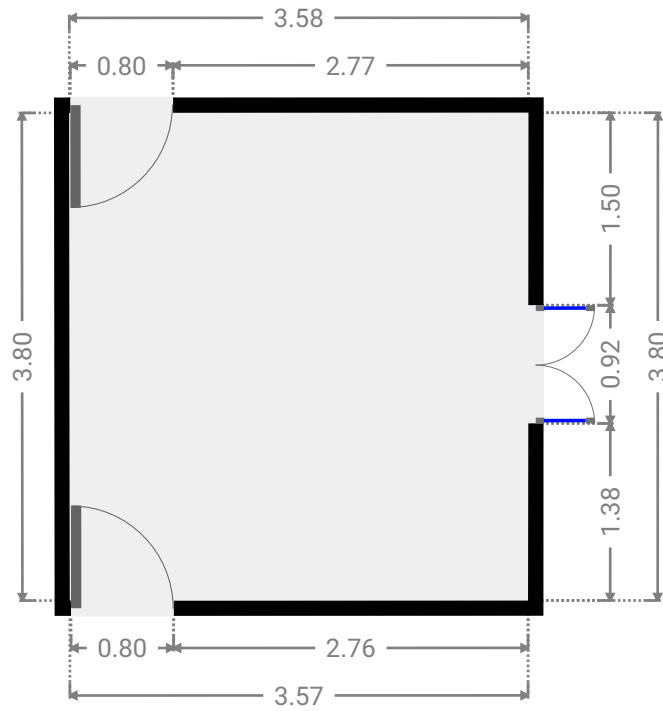
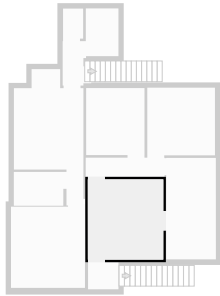

▼ Living Room  
1st Floor

WIDTH: 2.35 m • LENGTH: 4.80 m  
AREA: 11.27 m<sup>2</sup> • PERIMETER: 14.29 m

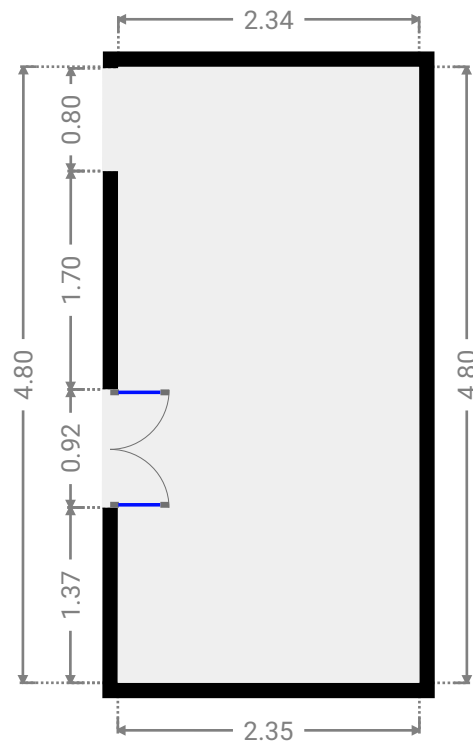
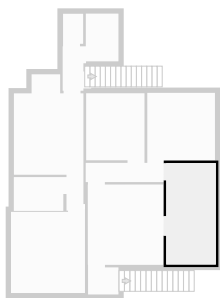

▼ **Hall**  
1st Floor

WIDTH: 3.73 m • LENGTH: 0.91 m  
AREA: 3.39 m<sup>2</sup> • PERIMETER: 9.28 m

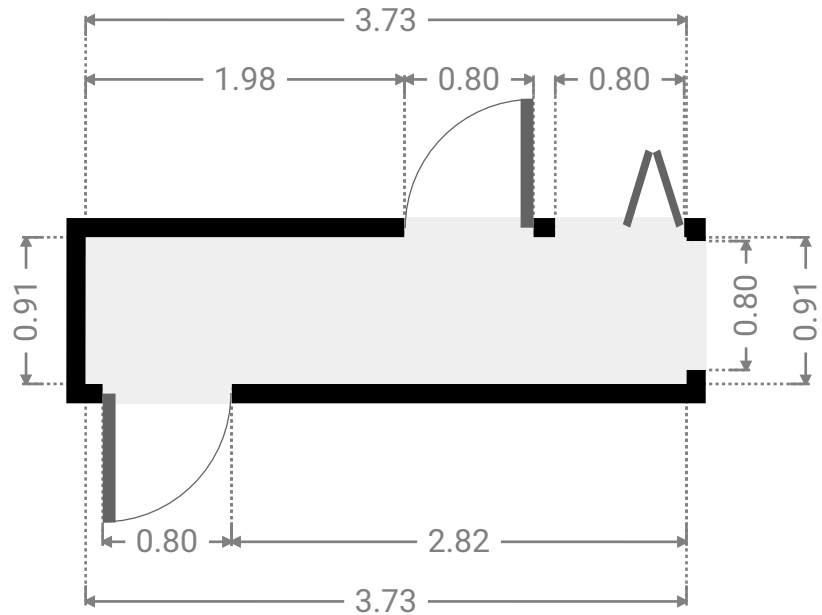
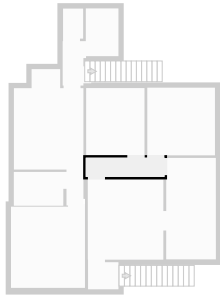

▼ **Bedroom**  
1st Floor

WIDTH: 3.20 m • LENGTH: 3.20 m  
AREA: 10.24 m<sup>2</sup> • PERIMETER: 12.80 m

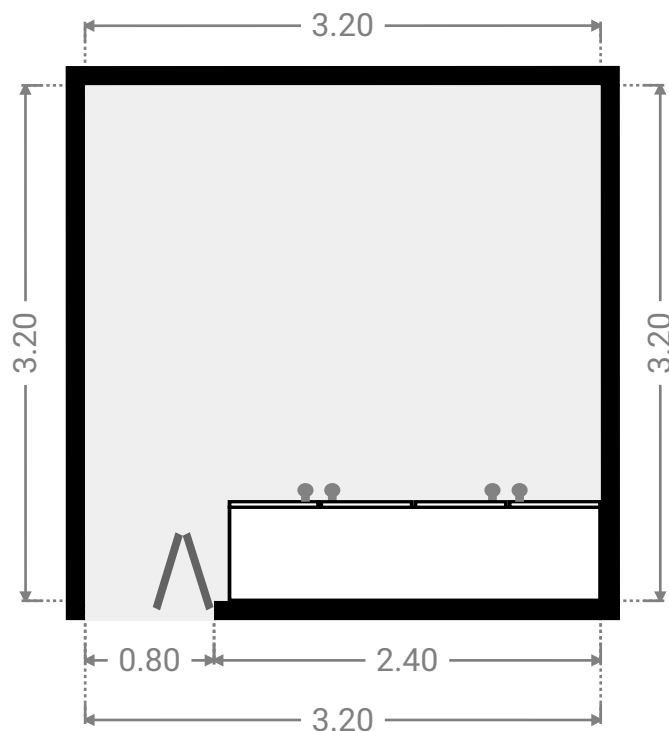
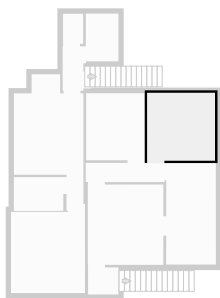

▼ **Bedroom**  
1st Floor

WIDTH: 2.76 m • LENGTH: 3.17 m  
AREA: 8.75 m<sup>2</sup> • PERIMETER: 11.86 m

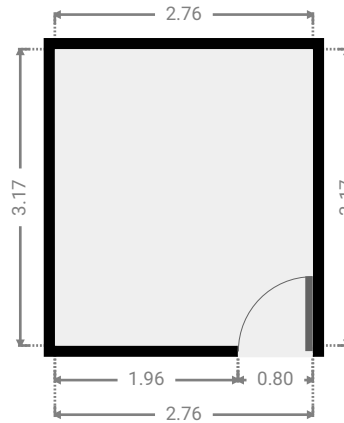
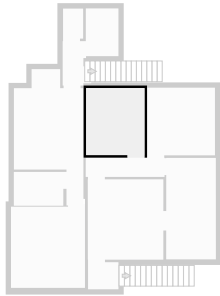

▼ **Kitchen**  
1st Floor

WIDTH: 3.29 m • LENGTH: 6.45 m  
AREA: 15.24 m<sup>2</sup> • PERIMETER: 19.48 m

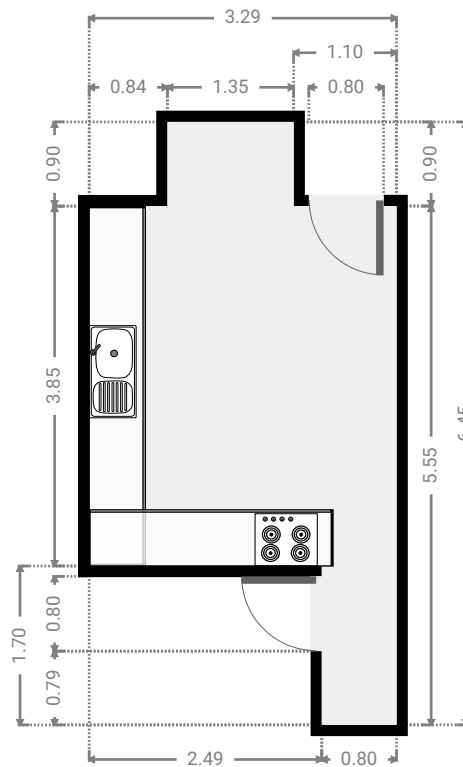
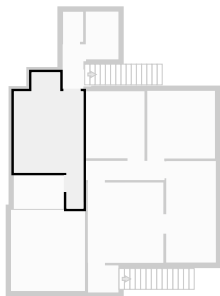

▼ **Hall**  
1st Floor

WIDTH: 0.98 m • LENGTH: 2.10 m  
AREA: 2.06 m<sup>2</sup> • PERIMETER: 6.16 m

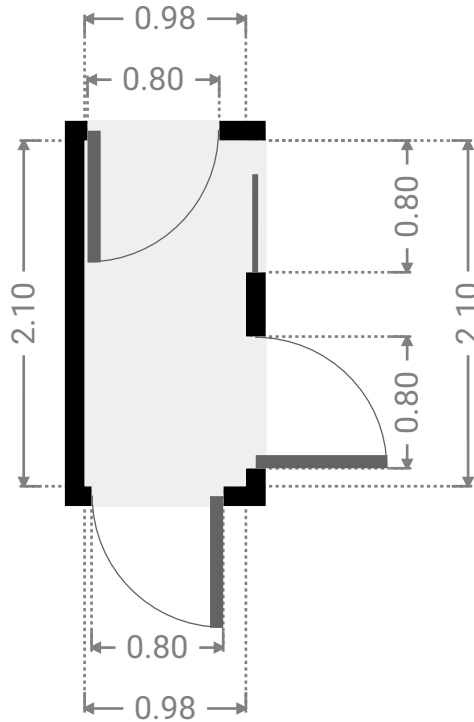
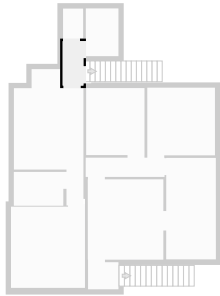

▼ **Toilet**  
1st Floor

WIDTH: 0.95 m • LENGTH: 1.42 m  
AREA: 1.35 m<sup>2</sup> • PERIMETER: 4.74 m

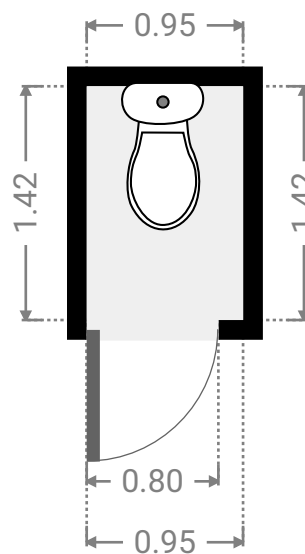
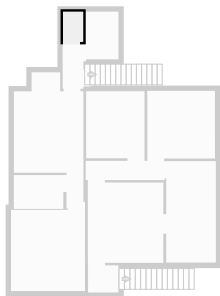



▼ **Bathroom**  
1st Floor

WIDTH: 1.54 m • LENGTH: 2.26 m  
AREA: 3.48 m<sup>2</sup> • PERIMETER: 7.60 m

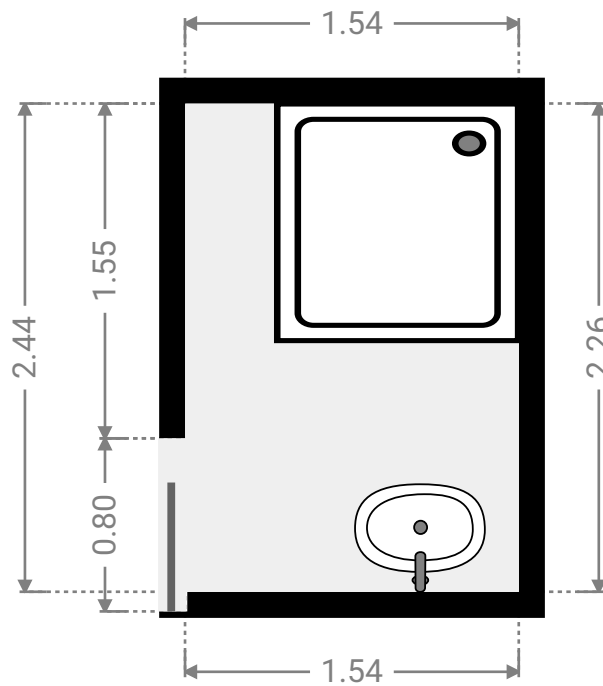
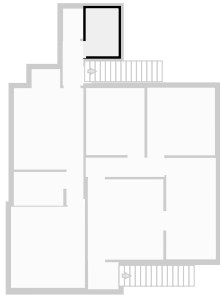

▼ **Bathroom**  
1st Floor

WIDTH: 2.34 m • LENGTH: 1.60 m  
AREA: 3.74 m<sup>2</sup> • PERIMETER: 7.88 m

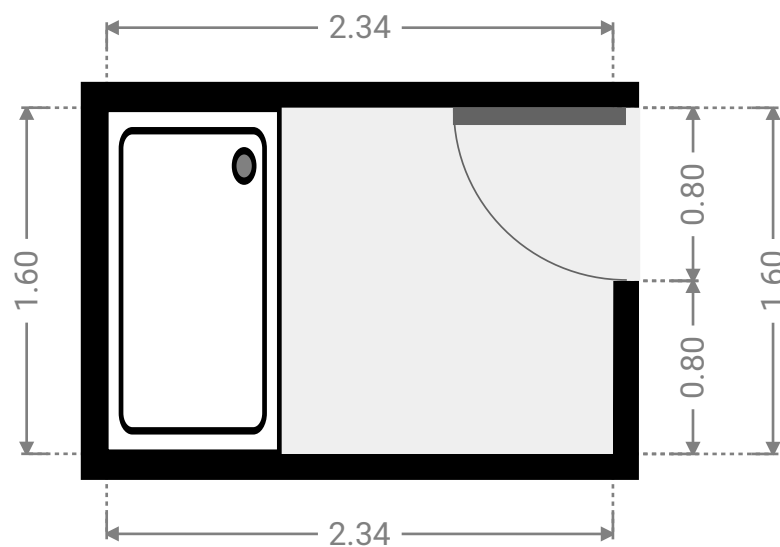
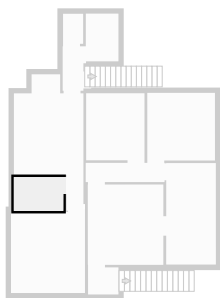

▼ **Bedroom**  
1st Floor

WIDTH: 3.50 m • LENGTH: 3.84 m  
AREA: 13.44 m<sup>2</sup> • PERIMETER: 14.68 m

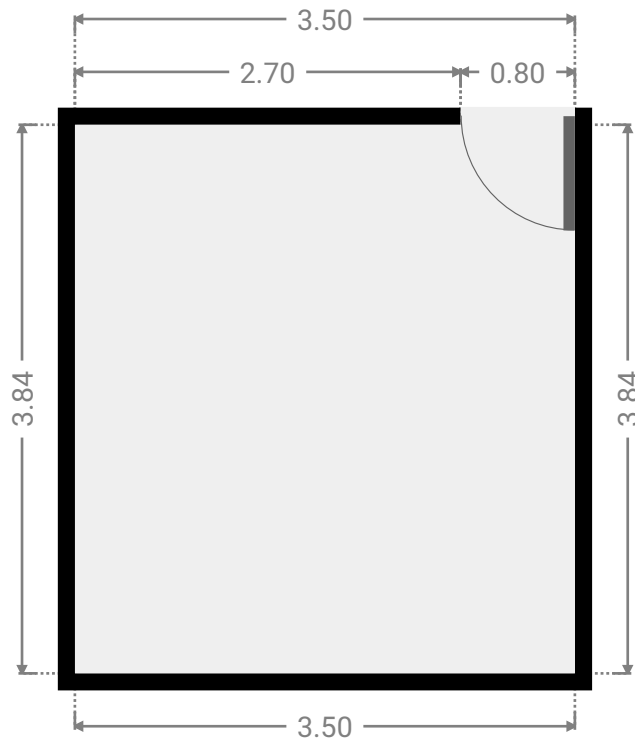
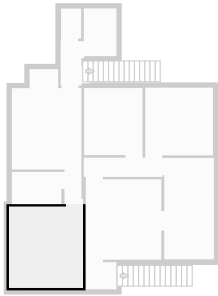

▼ **Other**  
1st Floor

WIDTH: 1.44 m • LENGTH: 1.28 m  
AREA: 1.84 m<sup>2</sup> • PERIMETER: 5.43 m

