

# 42 Herbert Street

**SUBMITTED BY**

Ray White Rockhampton Casey  
stockers@cqoz.com

---

**CREATED ON**

2021-11-16

---

**Floors**

2

---

▼ Ground Floor

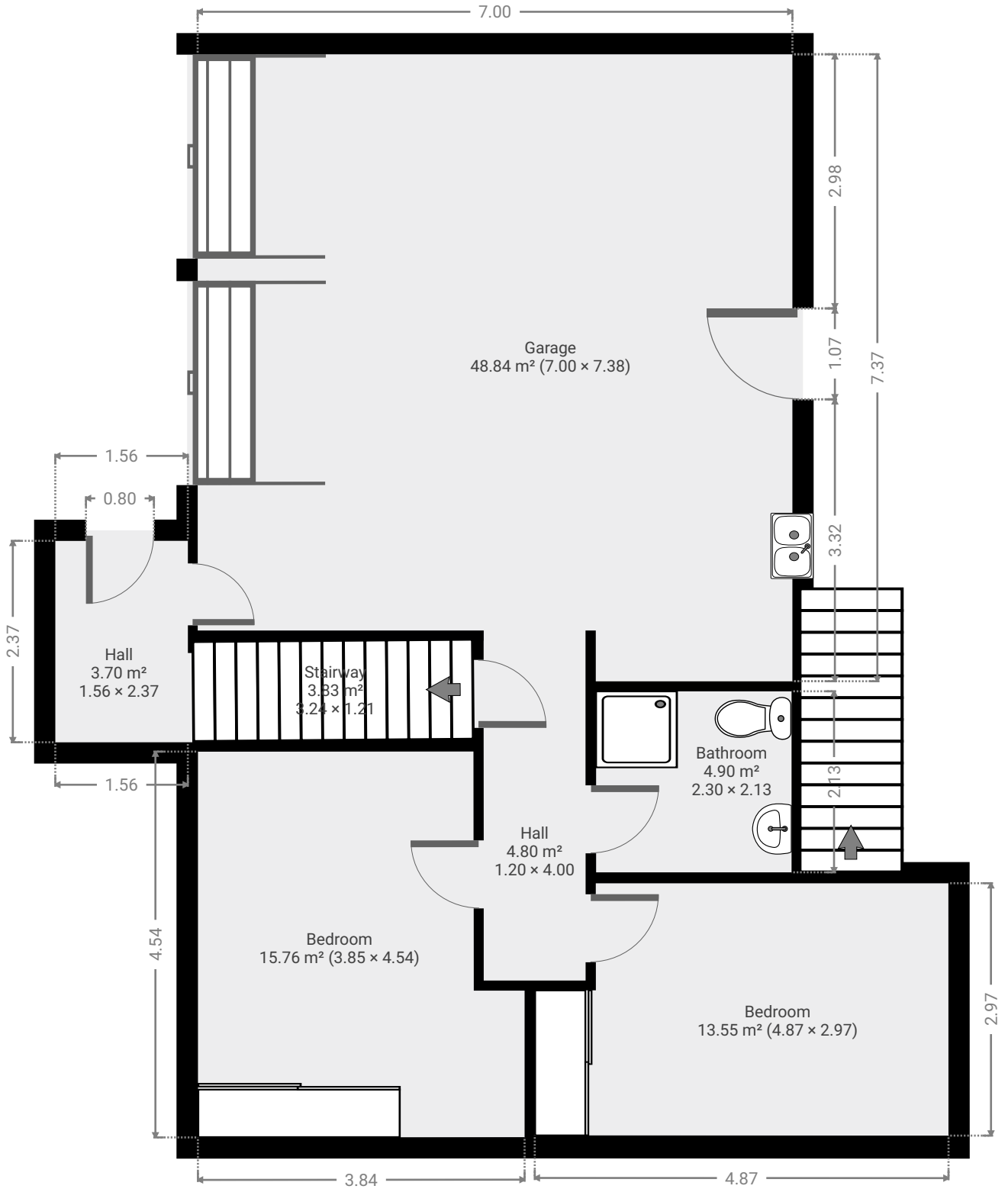

▼ **Hall**  
Ground Floor

WIDTH: 2.37 m • LENGTH: 1.56 m  
AREA: 3.70 m<sup>2</sup> • PERIMETER: 7.86 m

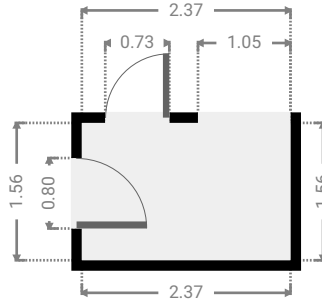
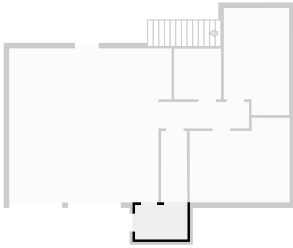

▼ **Garage**  
Ground Floor

WIDTH: 7.38 m • LENGTH: 7.00 m  
AREA: 48.84 m<sup>2</sup> • PERIMETER: 28.76 m

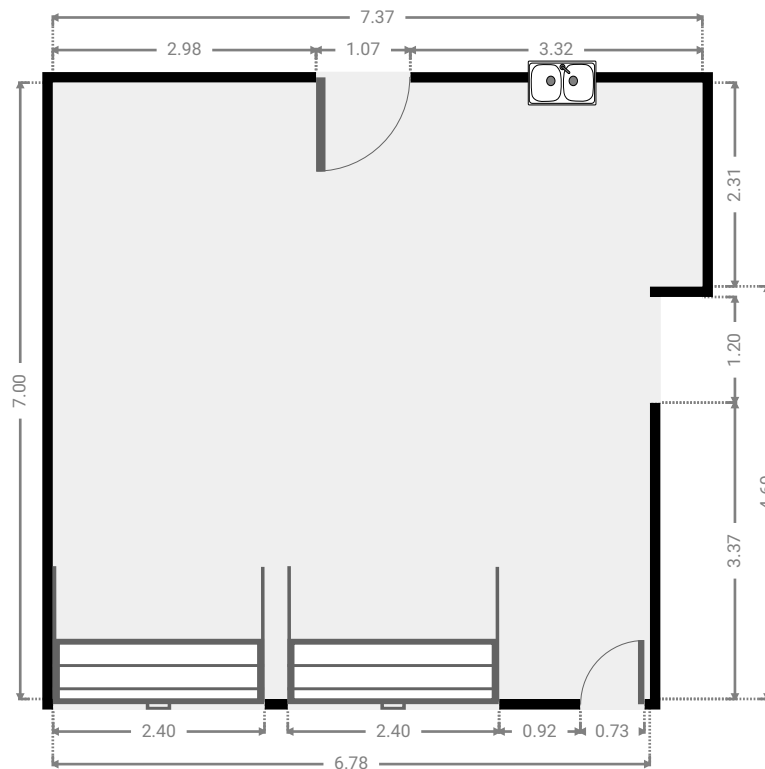
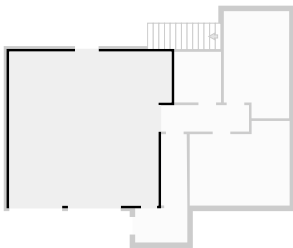

▼ **Hall**  
Ground Floor

WIDTH: 4.00 m • LENGTH: 1.20 m  
AREA: 4.80 m<sup>2</sup> • PERIMETER: 10.40 m

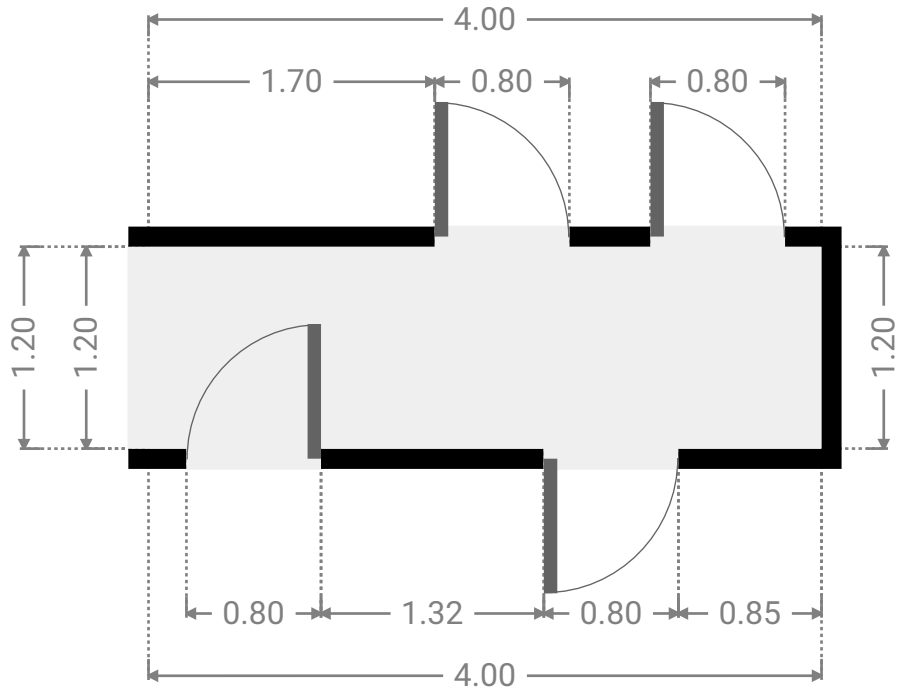
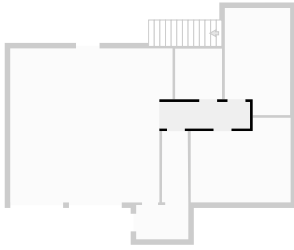

▼ **Bathroom**  
Ground Floor

WIDTH: 2.13 m • LENGTH: 2.30 m  
AREA: 4.90 m<sup>2</sup> • PERIMETER: 8.86 m

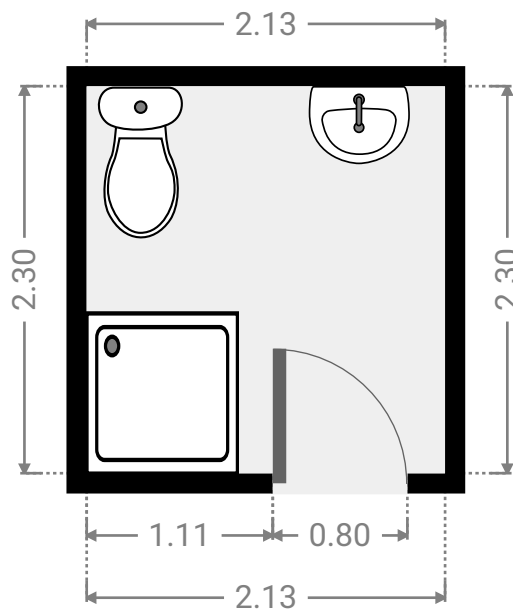
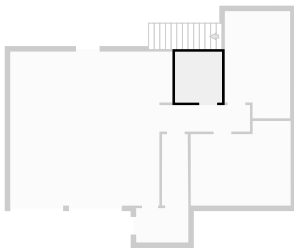

▼ **Bedroom**  
Ground Floor

WIDTH: 2.97 m • LENGTH: 4.87 m  
AREA: 13.55 m<sup>2</sup> • PERIMETER: 15.68 m

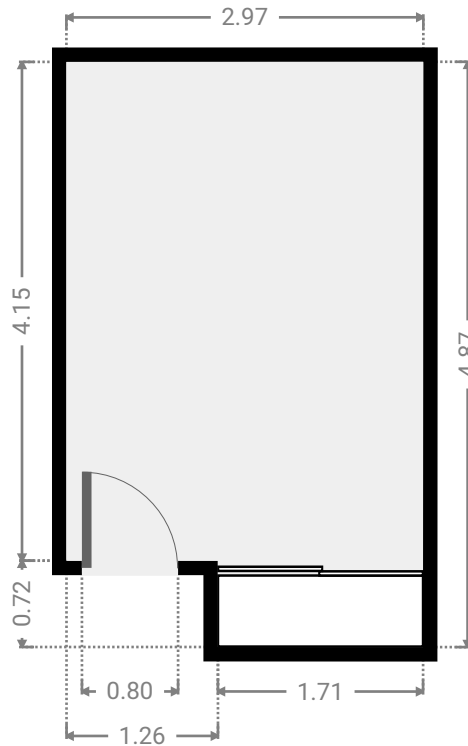
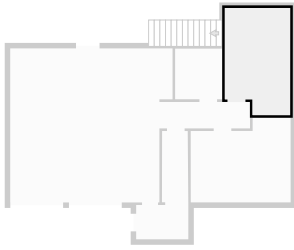

▼ **Bedroom**  
Ground Floor

WIDTH: 4.54 m • LENGTH: 3.85 m  
AREA: 15.76 m<sup>2</sup> • PERIMETER: 16.76 m

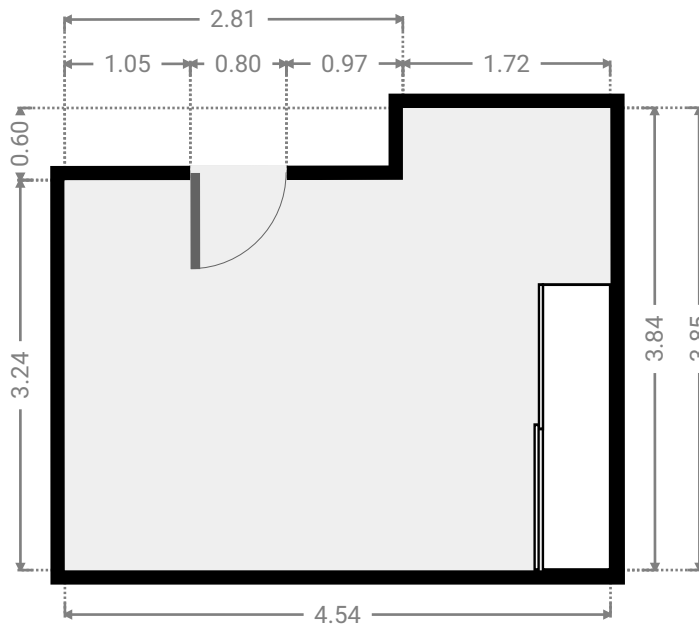
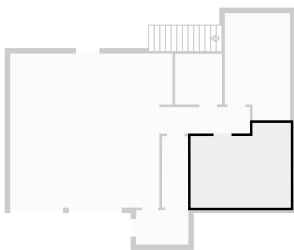

▼ **Stairway**  
Ground Floor

WIDTH: 1.21 m • LENGTH: 3.24 m  
AREA: 3.83 m<sup>2</sup> • PERIMETER: 8.84 m

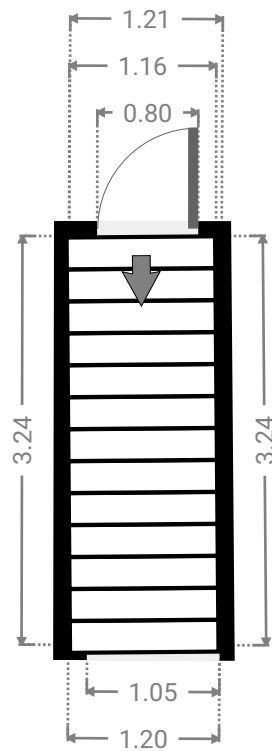
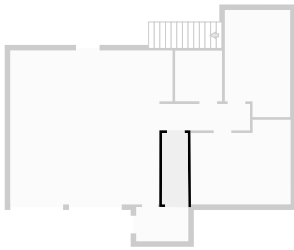

▼ 1st Floor

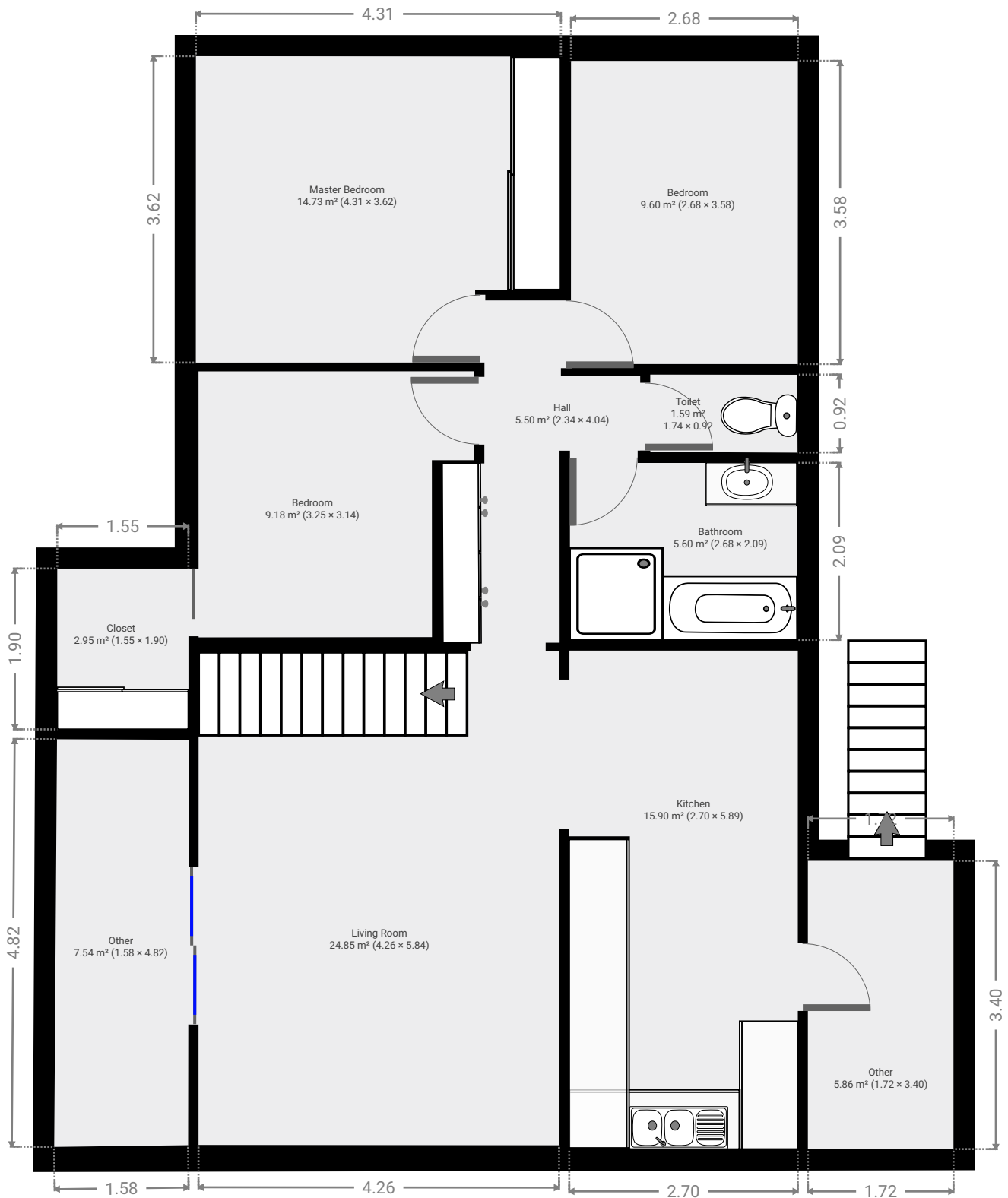

▼ **Living Room**  
1st Floor

WIDTH: 5.84 m • LENGTH: 4.26 m  
AREA: 24.85 m<sup>2</sup> • PERIMETER: 20.19 m

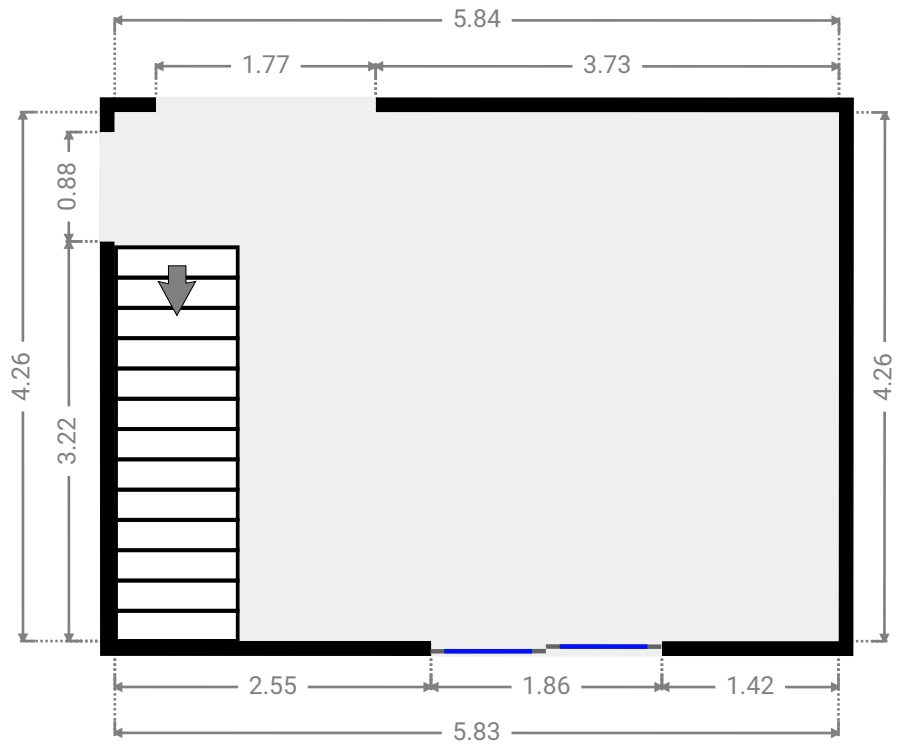
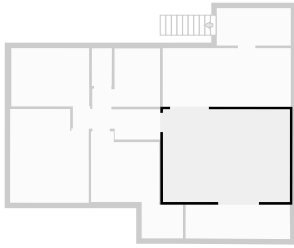

▼ **Kitchen**  
1st Floor

WIDTH: 5.89 m • LENGTH: 2.70 m  
AREA: 15.90 m<sup>2</sup> • PERIMETER: 17.18 m

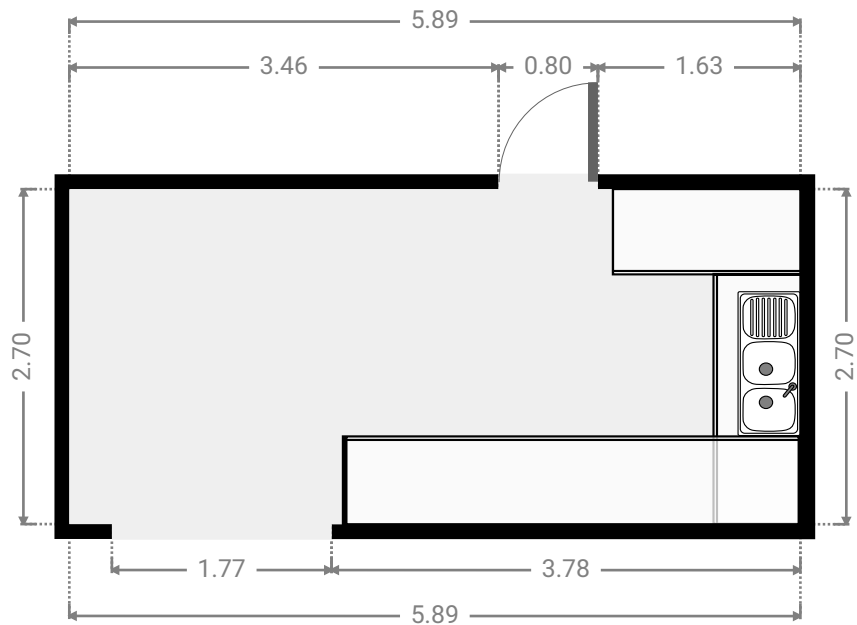
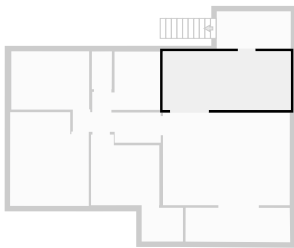



▼ **Hall**  
1st Floor

WIDTH: 4.04 m • LENGTH: 2.34 m  
AREA: 5.50 m<sup>2</sup> • PERIMETER: 12.77 m

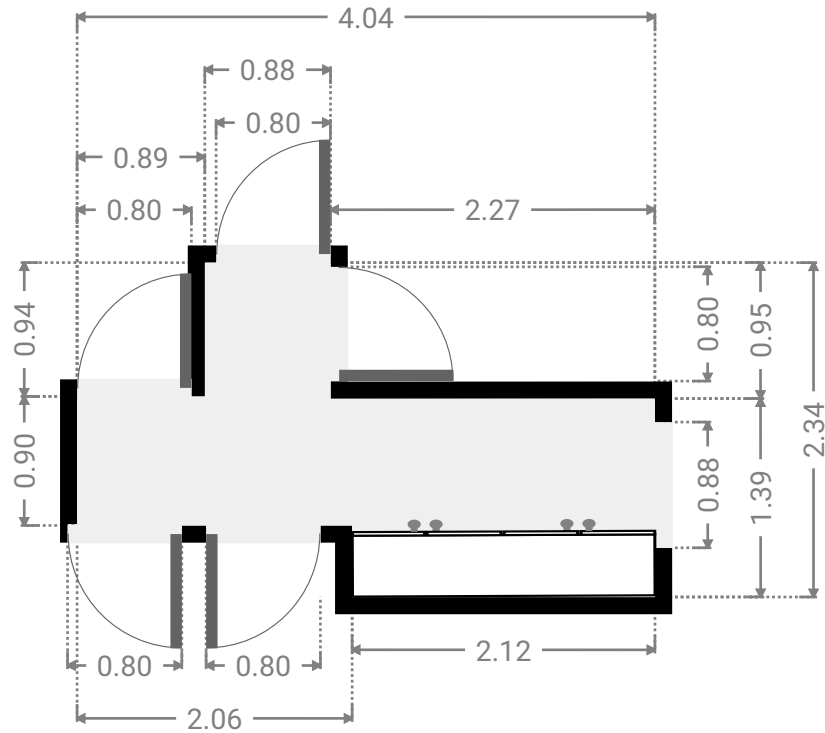
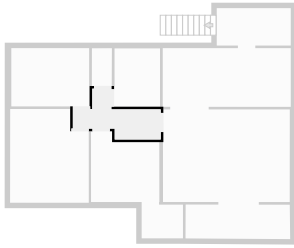

▼ **Bedroom**  
1st Floor

WIDTH: 3.14 m • LENGTH: 3.25 m  
AREA: 9.18 m<sup>2</sup> • PERIMETER: 12.78 m

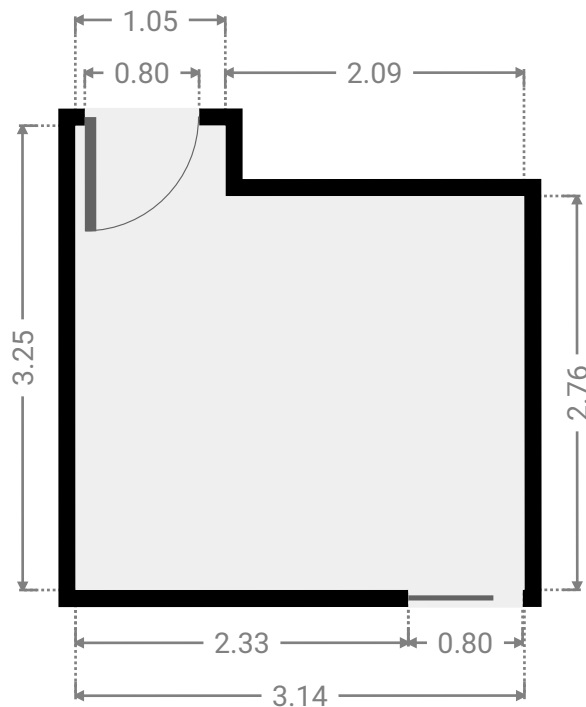
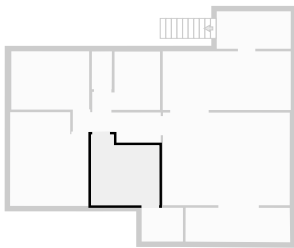

▼ **Closet**  
1st Floor

WIDTH: 1.90 m • LENGTH: 1.55 m  
AREA: 2.95 m<sup>2</sup> • PERIMETER: 6.90 m

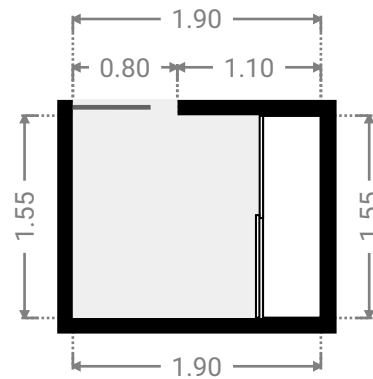
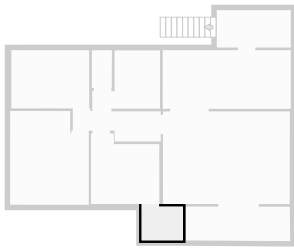

▼ **Master Bedroom**  
1st Floor

WIDTH: 3.62 m • LENGTH: 4.31 m  
AREA: 14.73 m<sup>2</sup> • PERIMETER: 15.86 m

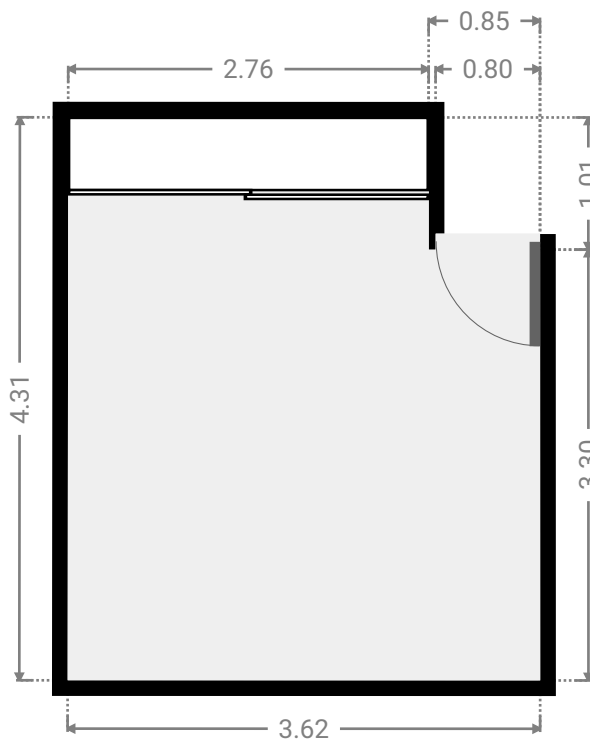
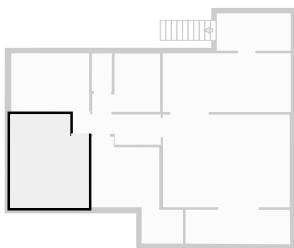

▼ **Bedroom**  
1st Floor

WIDTH: 3.58 m • LENGTH: 2.68 m  
AREA: 9.60 m<sup>2</sup> • PERIMETER: 12.52 m

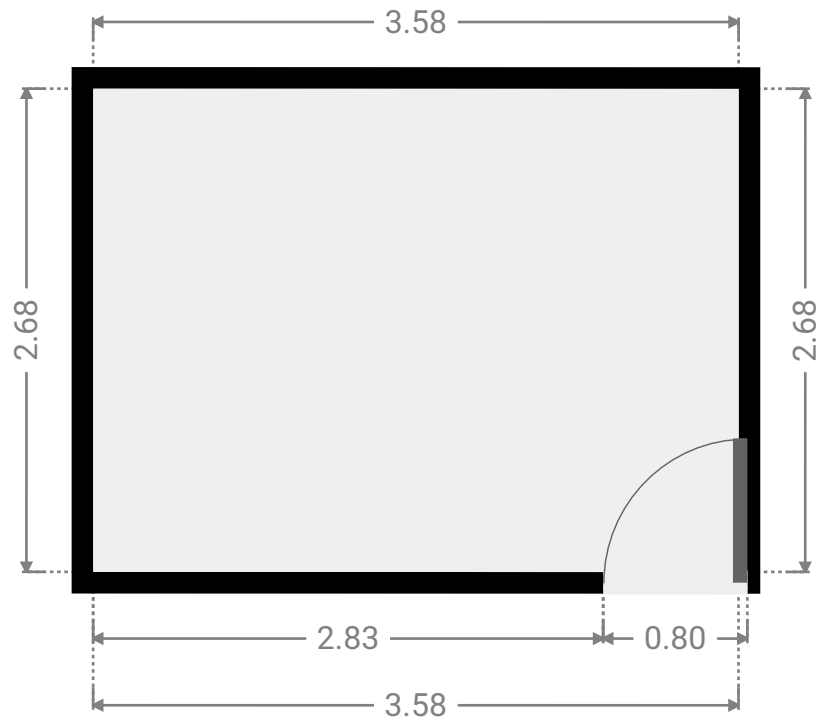
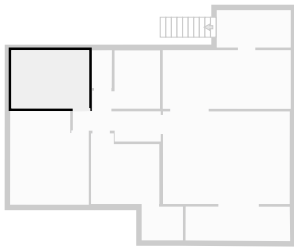

▼ **Bathroom**  
1st Floor

WIDTH: 2.09 m • LENGTH: 2.68 m  
AREA: 5.60 m<sup>2</sup> • PERIMETER: 9.54 m

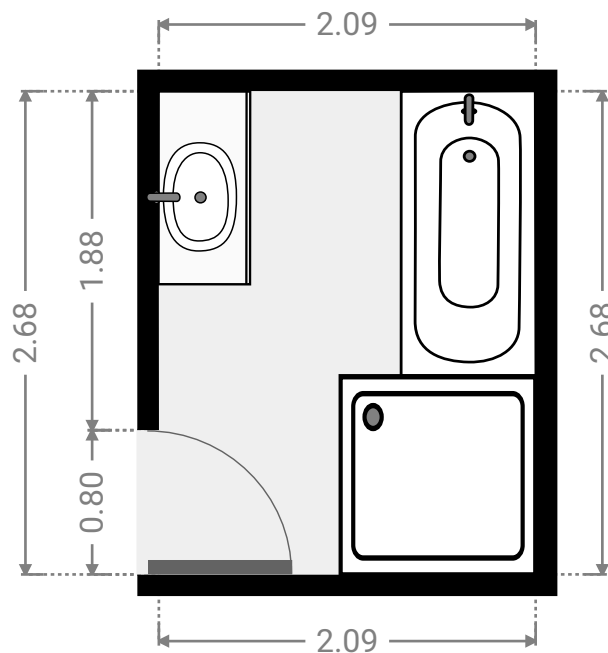
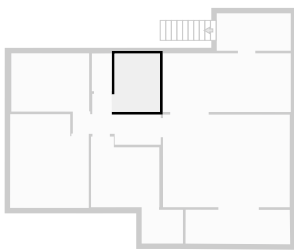

▼ Toilet  
1st Floor

WIDTH: 0.92 m • LENGTH: 1.74 m  
AREA: 1.59 m<sup>2</sup> • PERIMETER: 5.31 m

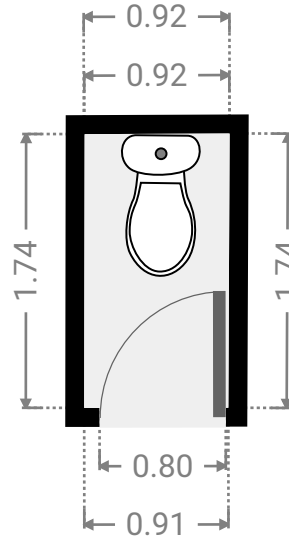
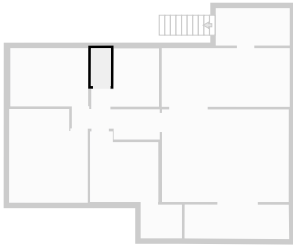

▼ Other  
1st Floor

WIDTH: 4.82 m • LENGTH: 1.58 m  
AREA: 7.54 m<sup>2</sup> • PERIMETER: 12.74 m

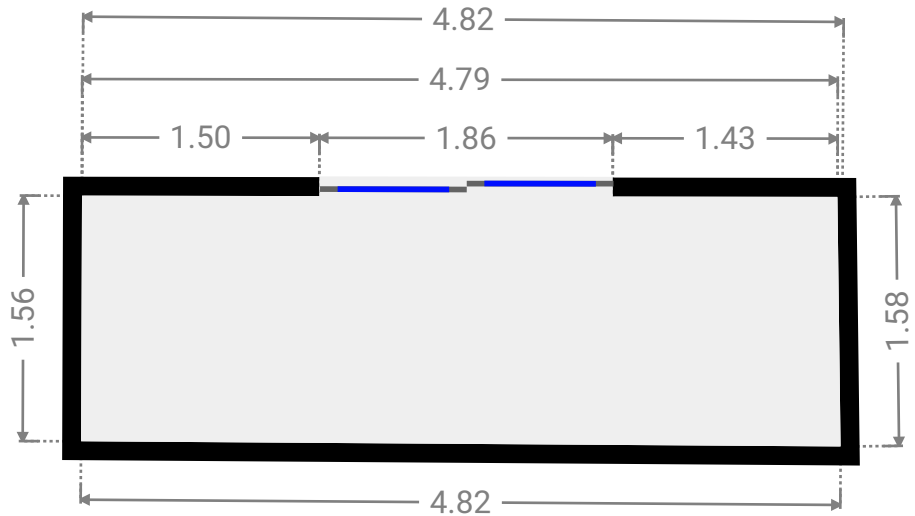
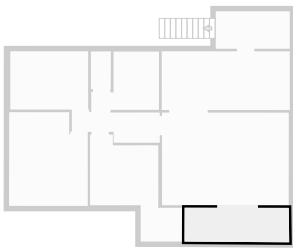

▼ Other  
1st Floor

WIDTH: 3.40 m • LENGTH: 1.72 m  
AREA: 5.86 m<sup>2</sup> • PERIMETER: 10.25 m

