

42 Capricorn Crescent

Ground Floor

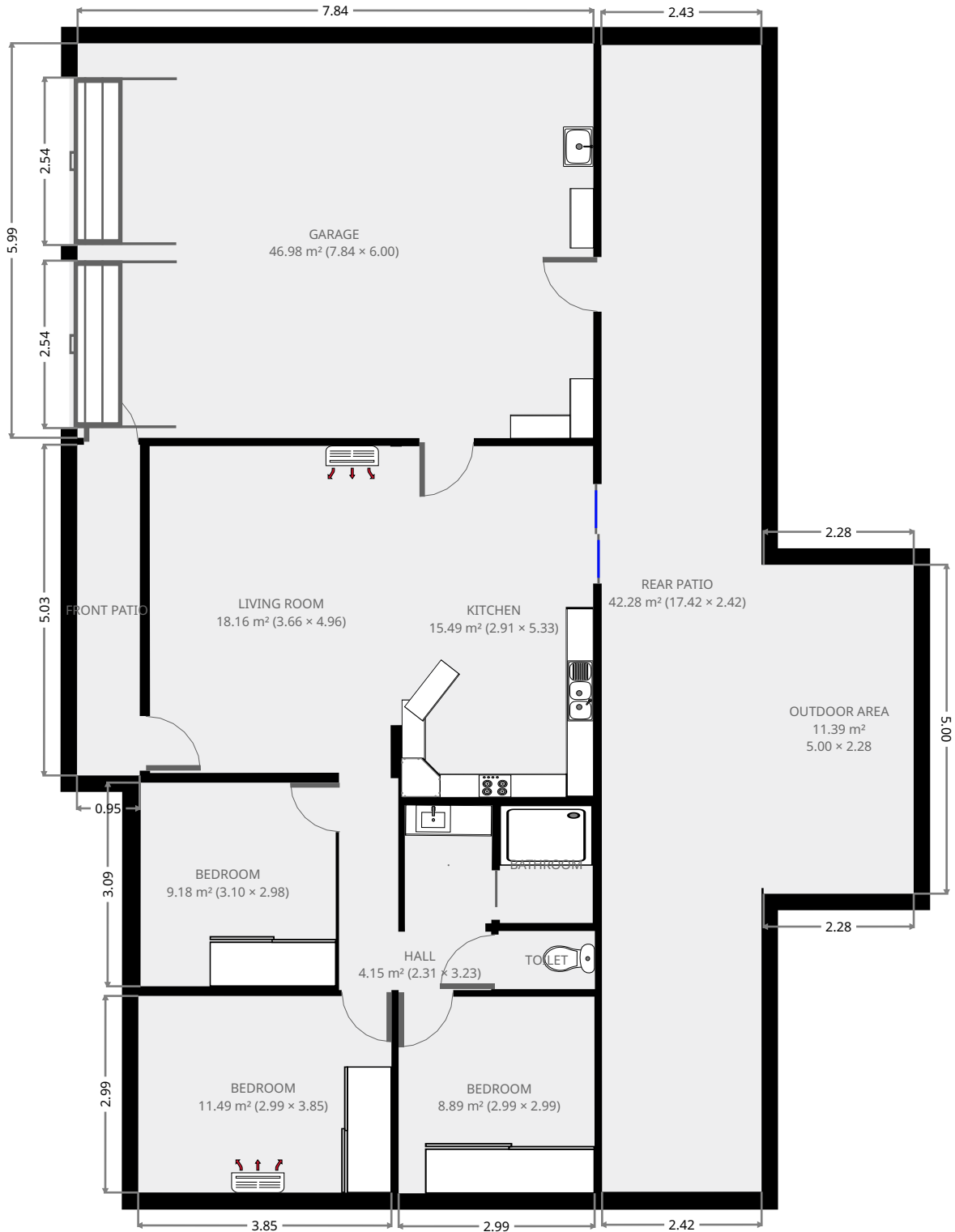

THIS FLOORPLAN IS PROVIDED WITHOUT WARRANTY OF ANY KIND. SENSOPIA DISCLAIMS ANY WARRANTY INCLUDING, WITHOUT LIMITATION, SATISFACTORY QUALITY OR ACCURACY OF DIMENSIONS.



42 Capricorn Crescent

Living Room

Width: 3.66 m
 Length: 4.96 m
 Area: 18.16 m²
 Perimeter: 17.24 m

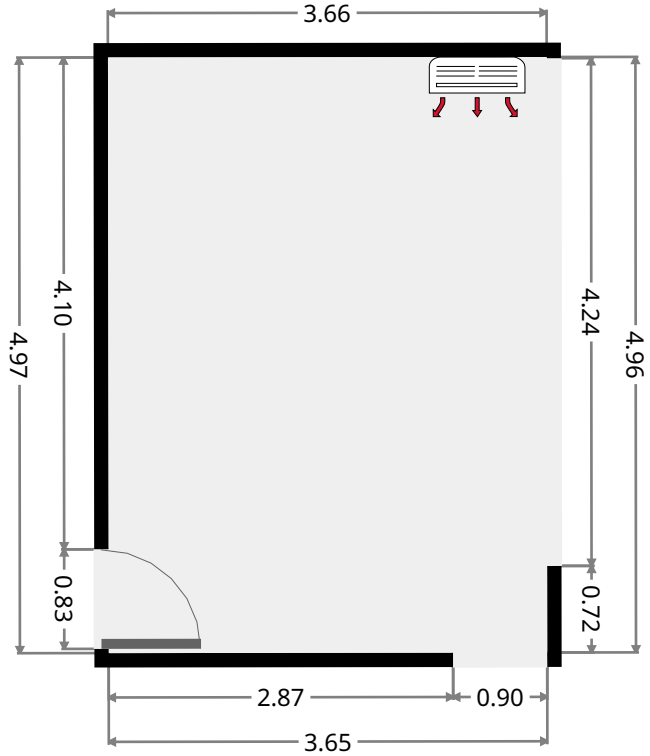
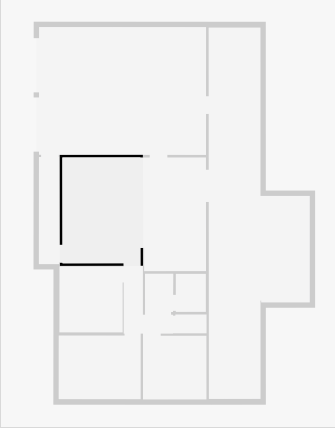

Kitchen

Width: 2.91 m
 Length: 5.33 m
 Area: 15.49 m²
 Perimeter: 16.47 m

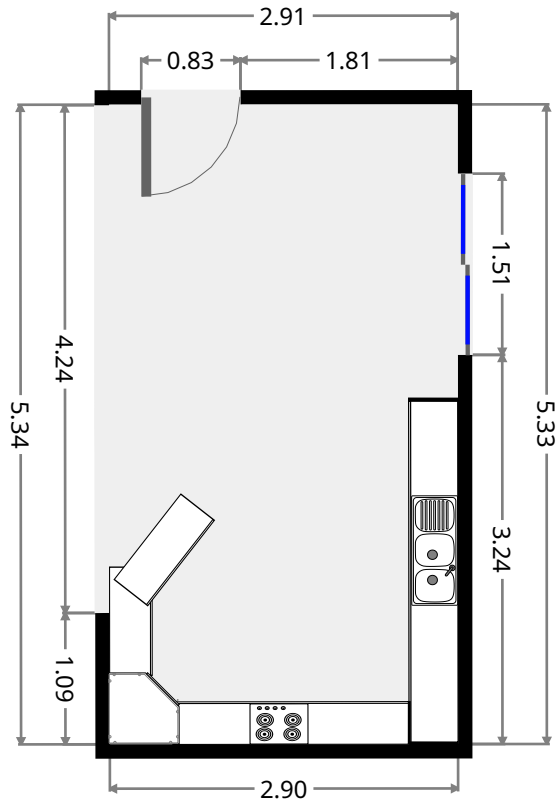
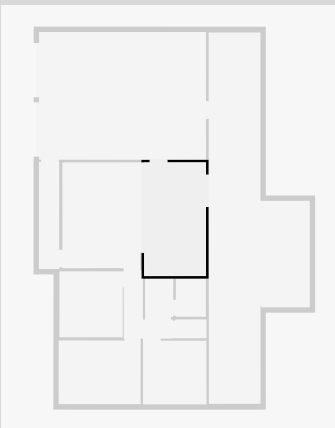

THIS FLOORPLAN IS PROVIDED WITHOUT WARRANTY OF ANY KIND. SENSOPIA DISCLAIMS ANY WARRANTY INCLUDING, WITHOUT LIMITATION, SATISFACTORY QUALITY OR ACCURACY OF DIMENSIONS.

42 Capricorn Crescent

Garage

Width: 6.00 m
 Length: 7.84 m
 Area: 46.98 m²
 Perimeter: 27.66 m

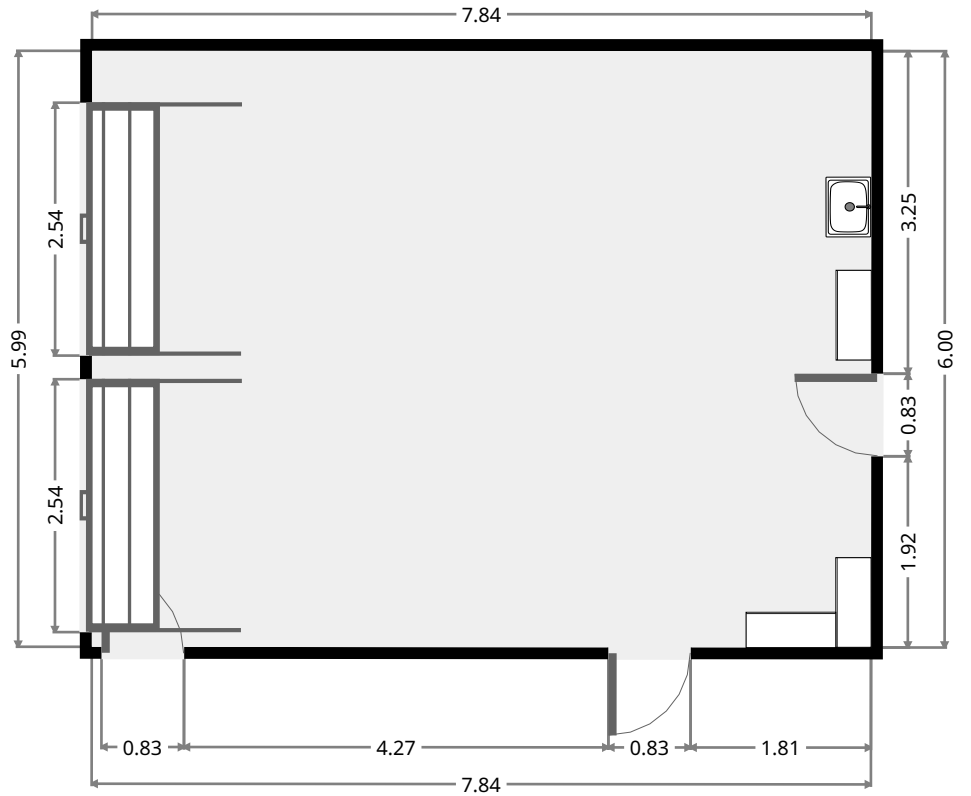
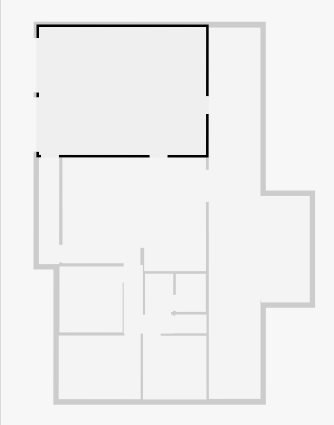

Hall

Width: 2.31 m
 Length: 3.23 m
 Area: 4.15 m²
 Perimeter: 11.06 m

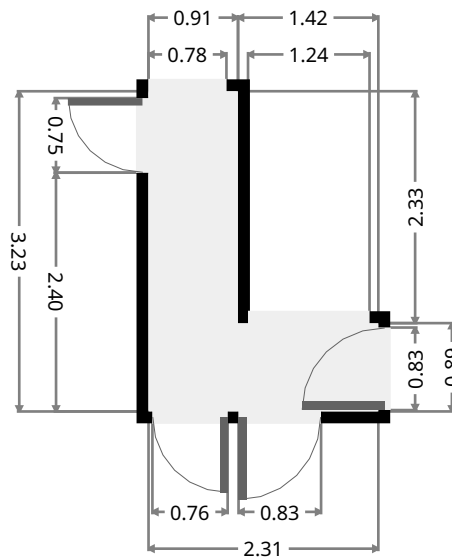
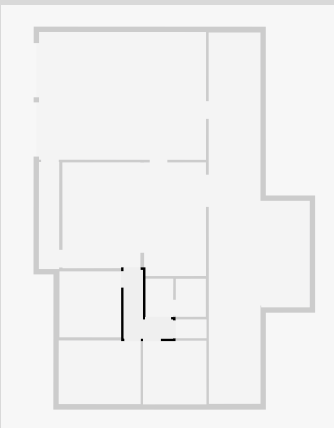

THIS FLOORPLAN IS PROVIDED WITHOUT WARRANTY OF ANY KIND. SENSOPIA DISCLAIMS ANY WARRANTY INCLUDING, WITHOUT LIMITATION, SATISFACTORY QUALITY OR ACCURACY OF DIMENSIONS.

42 Capricorn Crescent

Bedroom

Width: 2.98 m
 Length: 3.10 m
 Area: 9.18 m²
 Perimeter: 12.12 m

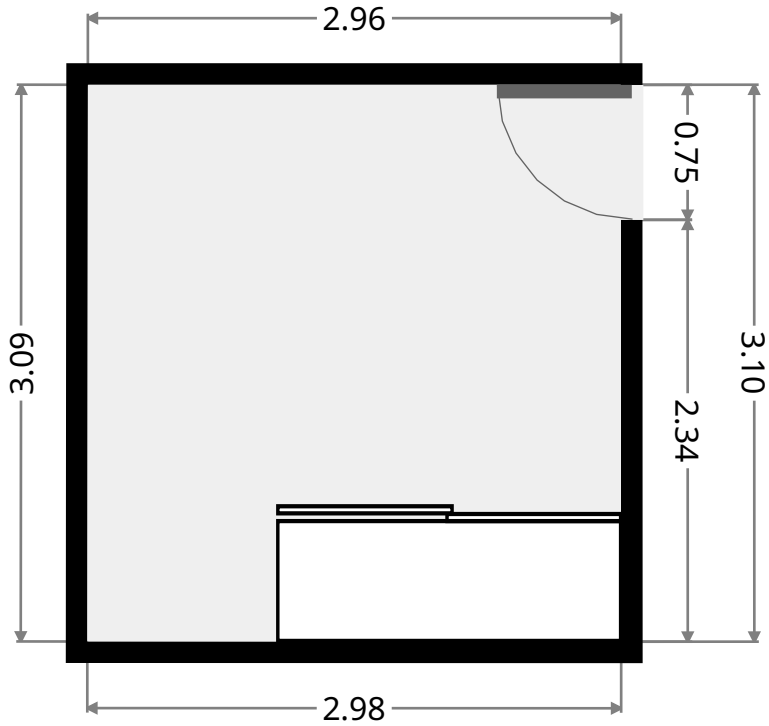
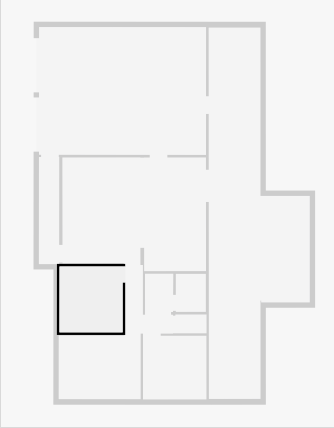

Bedroom

Width: 2.99 m
 Length: 3.85 m
 Area: 11.49 m²
 Perimeter: 13.67 m

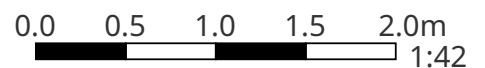
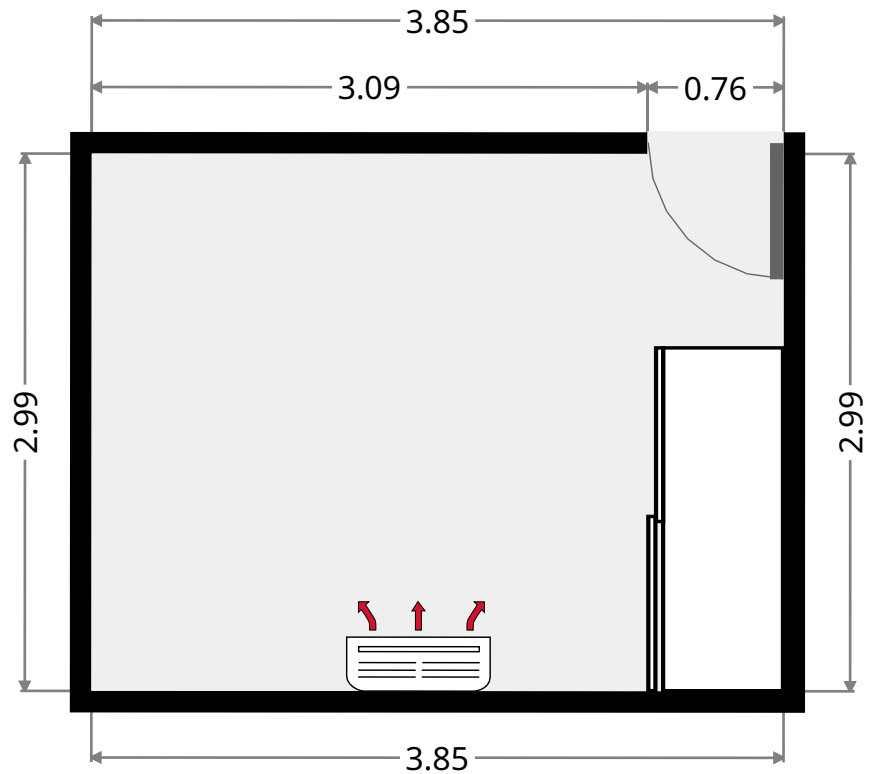
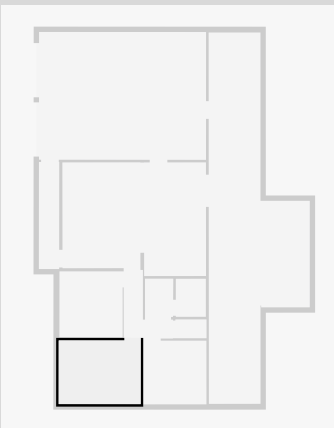

THIS FLOORPLAN IS PROVIDED WITHOUT WARRANTY OF ANY KIND. SENSOPIA DISCLAIMS ANY WARRANTY INCLUDING, WITHOUT LIMITATION, SATISFACTORY QUALITY OR ACCURACY OF DIMENSIONS.

42 Capricorn Crescent

Bedroom

Width: 2.99 m
 Length: 2.99 m
 Area: 8.89 m²
 Perimeter: 11.93 m

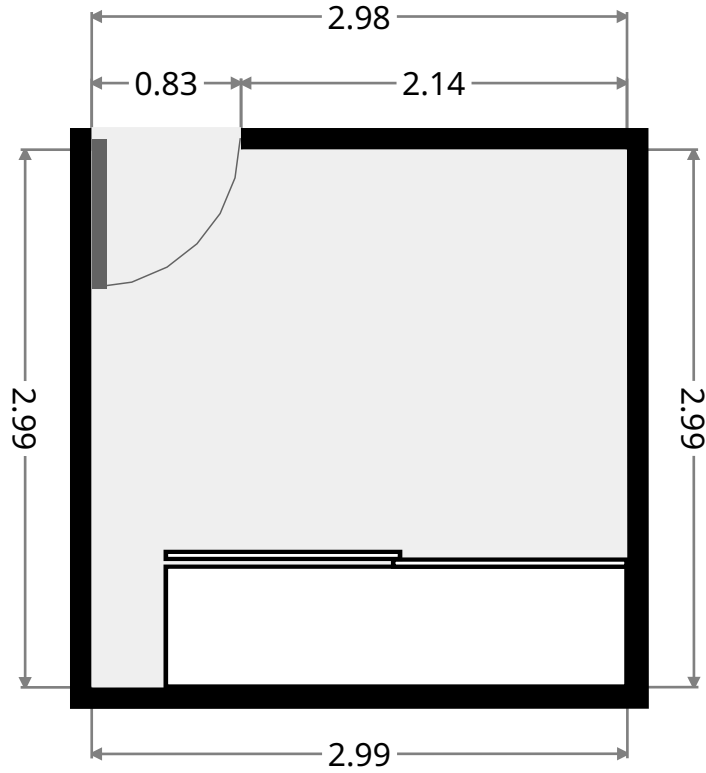
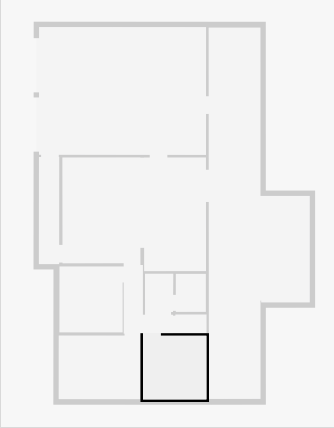

Toilet

Width: 0.88 m
 Length: 1.47 m
 Area: 1.29 m²
 Perimeter: 4.69 m

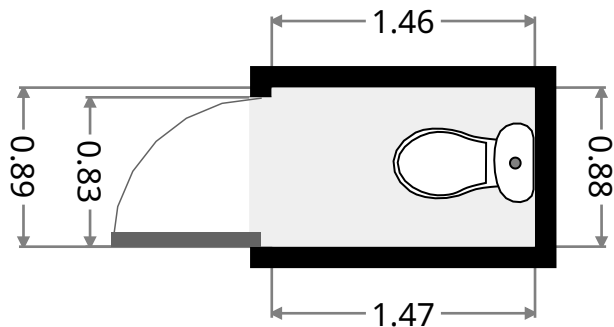
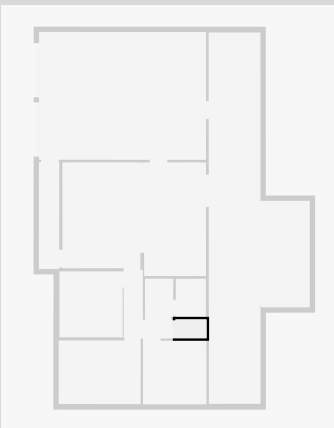

42 Capricorn Crescent

Bathroom

Width: 1.40 m
 Length: 1.79 m
 Area: 2.52 m²
 Perimeter: 6.39 m

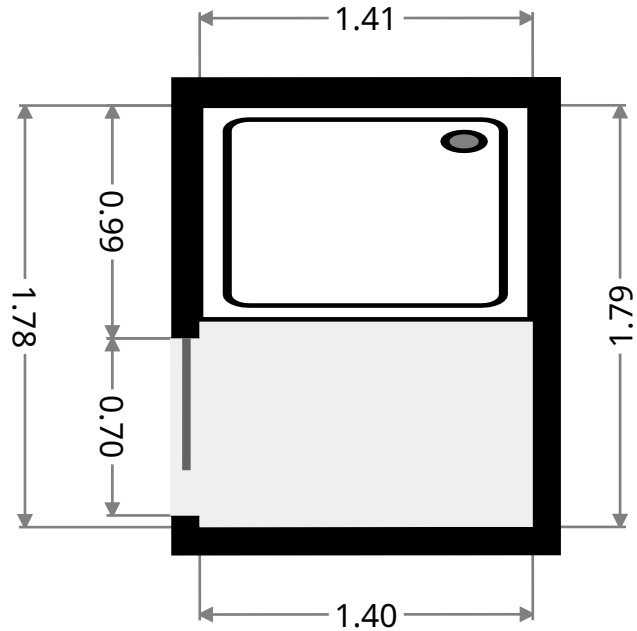
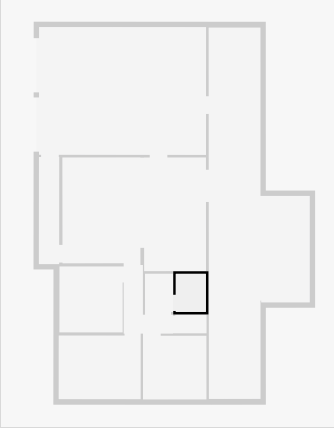

•
 Width: 1.33 m
 Length: 1.81 m
 Area: 2.38 m²
 Perimeter: 6.24 m

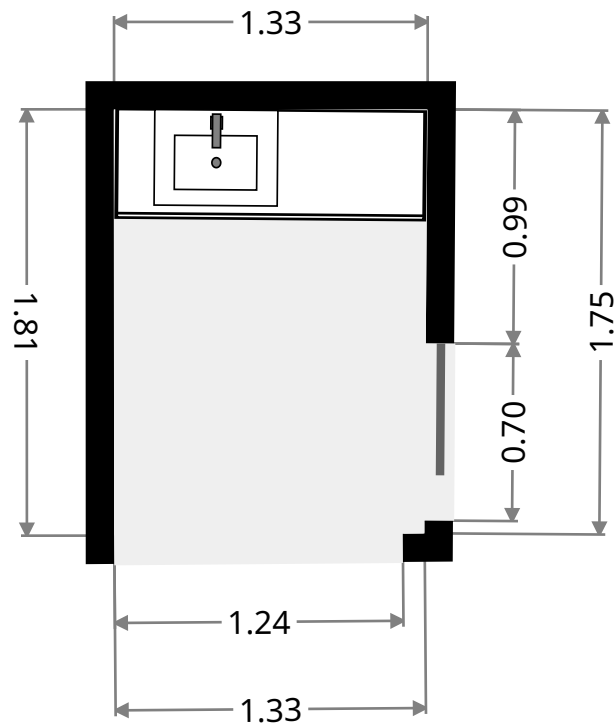
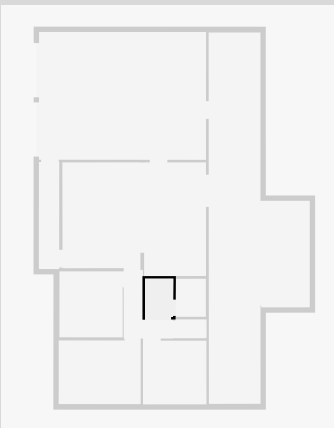

THIS FLOORPLAN IS PROVIDED WITHOUT WARRANTY OF ANY KIND. SENSOPIA DISCLAIMS ANY WARRANTY INCLUDING, WITHOUT LIMITATION, SATISFACTORY QUALITY OR ACCURACY OF DIMENSIONS.

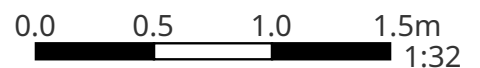

42 Capricorn Crescent

Rear Patio

Width: 2.42 m
Length: 17.42 m
Area: 42.28 m²
Perimeter: 39.70 m

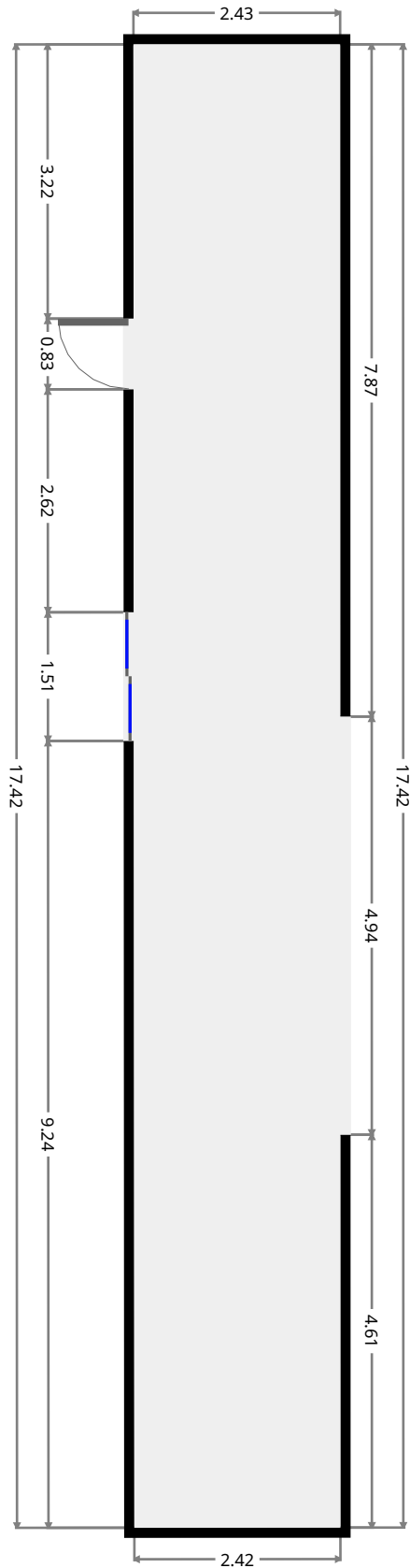
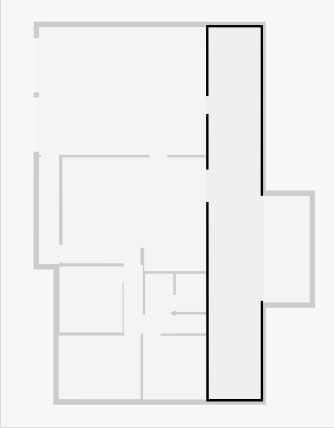

THIS FLOORPLAN IS PROVIDED WITHOUT WARRANTY OF ANY KIND. SENSOPIA DISCLAIMS ANY WARRANTY INCLUDING, WITHOUT LIMITATION, SATISFACTORY QUALITY OR ACCURACY OF DIMENSIONS.

42 Capricorn Crescent

Outdoor Area

Width: 2.28 m
 Length: 5.00 m
 Area: 11.39 m²
 Perimeter: 14.56 m

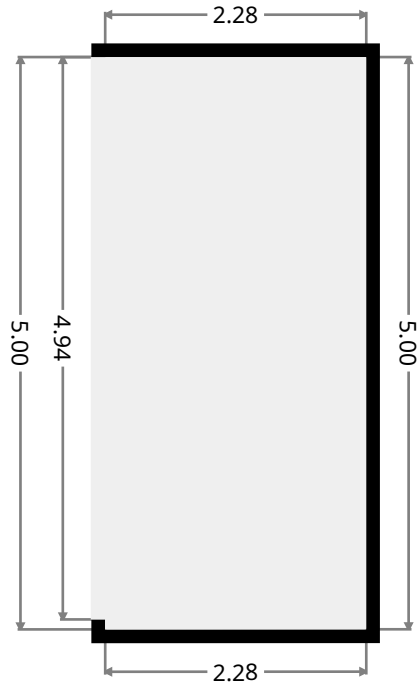
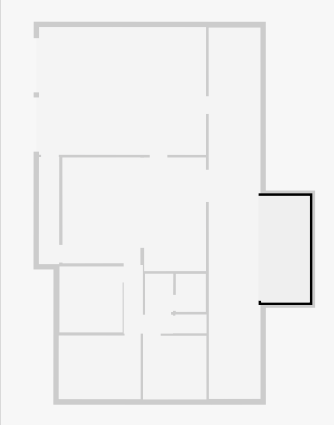

Front Patio

Width: 0.95 m
 Length: 5.02 m
 Area: 4.78 m²
 Perimeter: 11.95 m

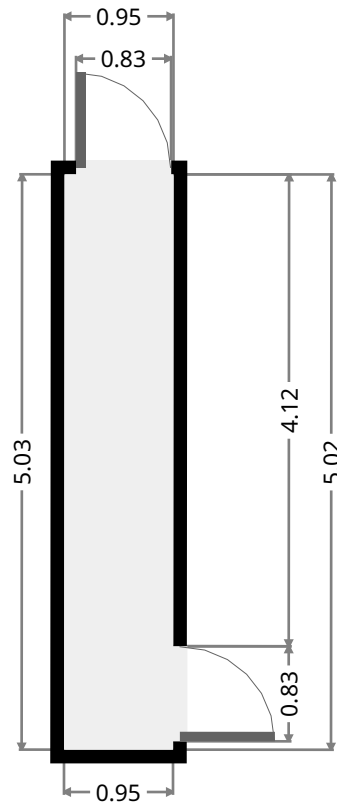
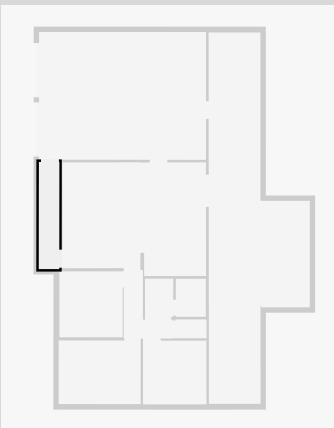

THIS FLOORPLAN IS PROVIDED WITHOUT WARRANTY OF ANY KIND. SENSOPIA DISCLAIMS ANY WARRANTY INCLUDING, WITHOUT LIMITATION, SATISFACTORY QUALITY OR ACCURACY OF DIMENSIONS.