

411 East Street

SUBMITTED BY

Ray White Rockhampton Casey
stockers@cqoz.com

CREATED ON

2022-12-19

Floors

2

▼ Ground Floor

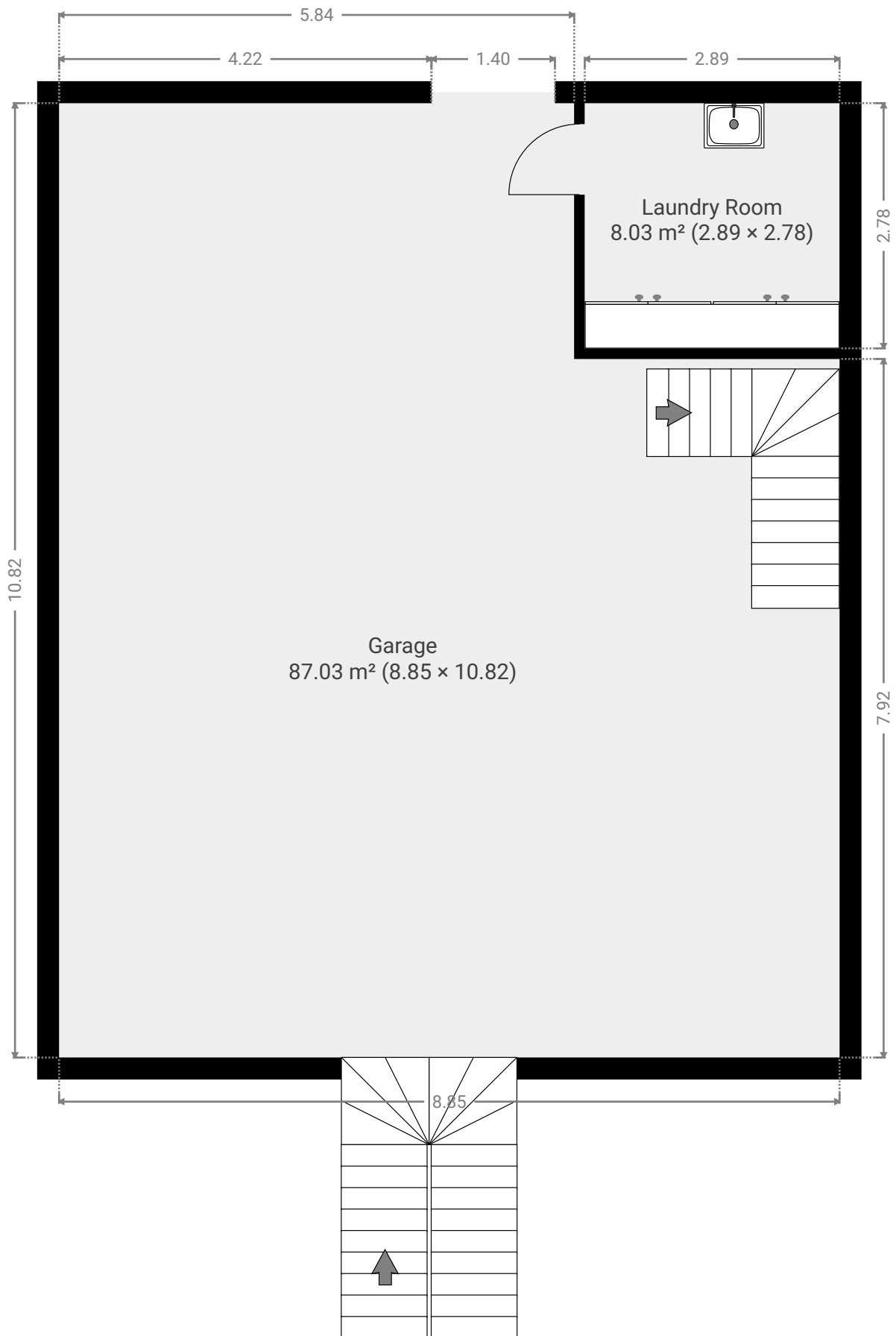

▼ **Garage**
Ground Floor

WIDTH: 8.85 m • LENGTH: 10.82 m
AREA: 87.03 m² • PERIMETER: 39.34 m

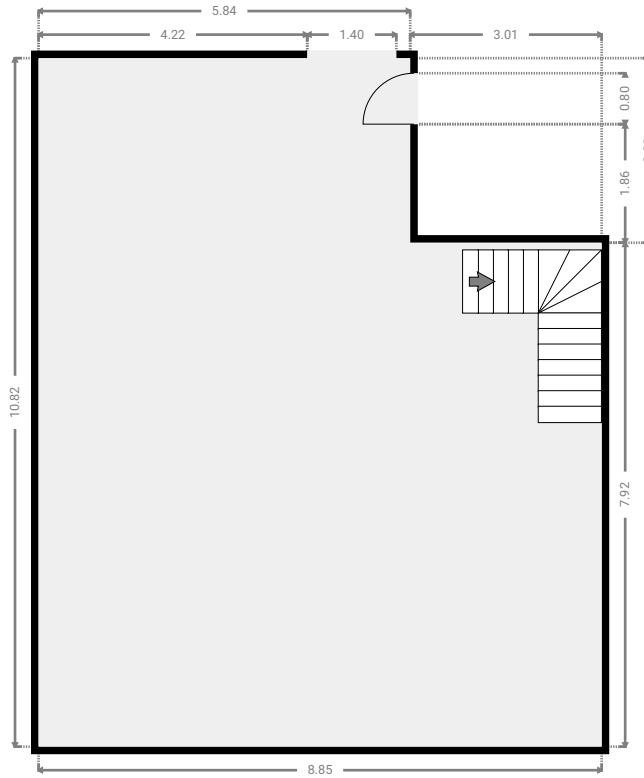
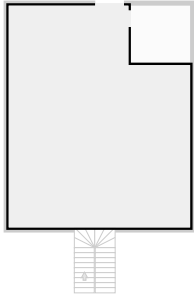

▼ **Laundry Room**
Ground Floor

WIDTH: 2.89 m • LENGTH: 2.78 m
AREA: 8.03 m² • PERIMETER: 11.34 m

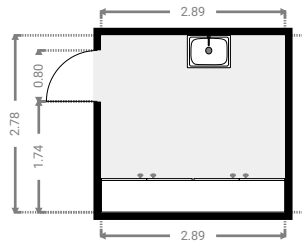
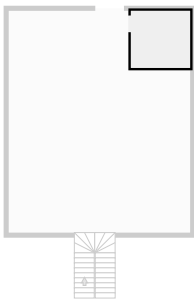

▼ 1st Floor

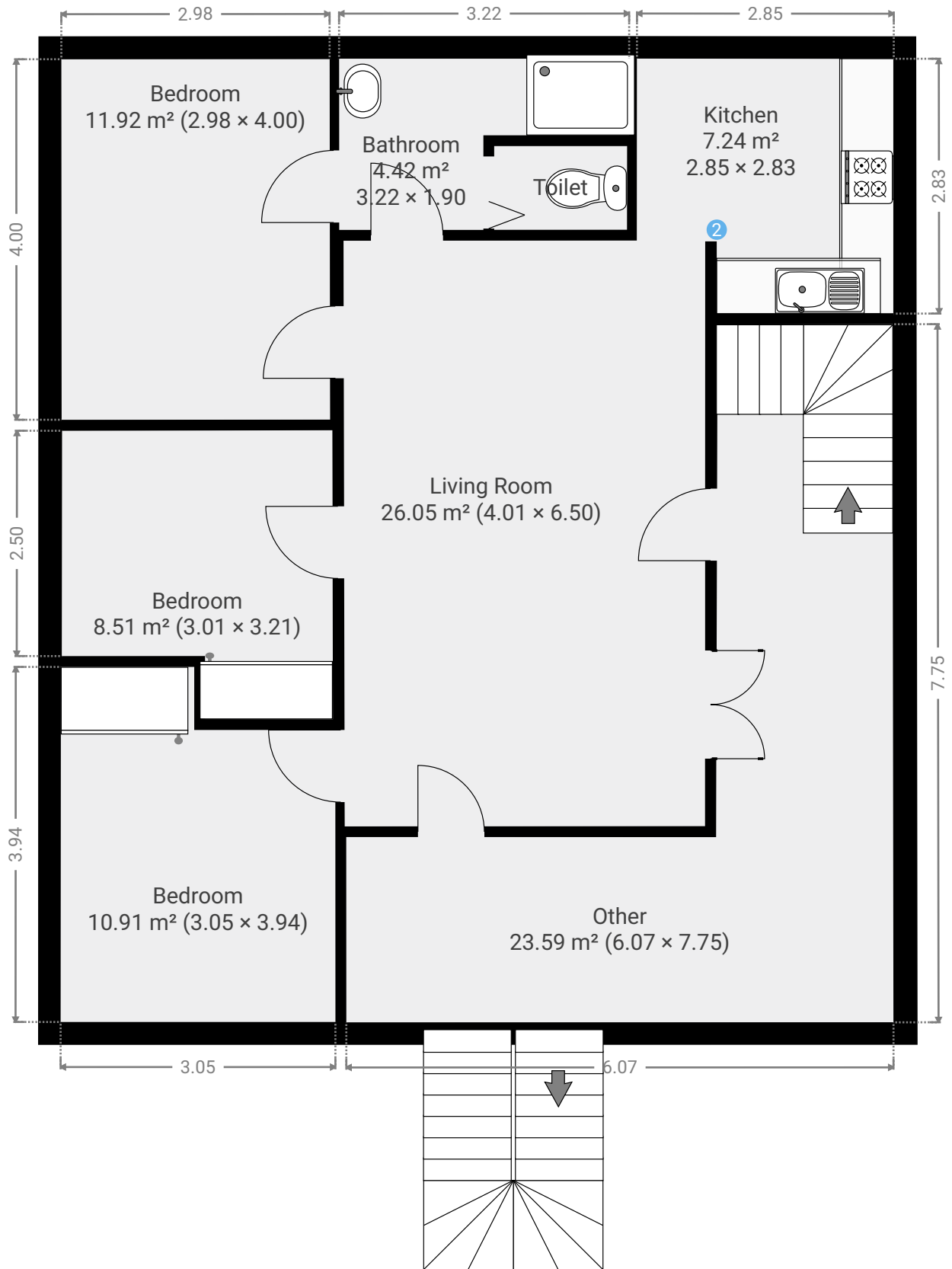

▼ **Bathroom**
1st Floor

WIDTH: 3.22 m • LENGTH: 1.90 m
AREA: 4.42 m² • PERIMETER: 10.24 m

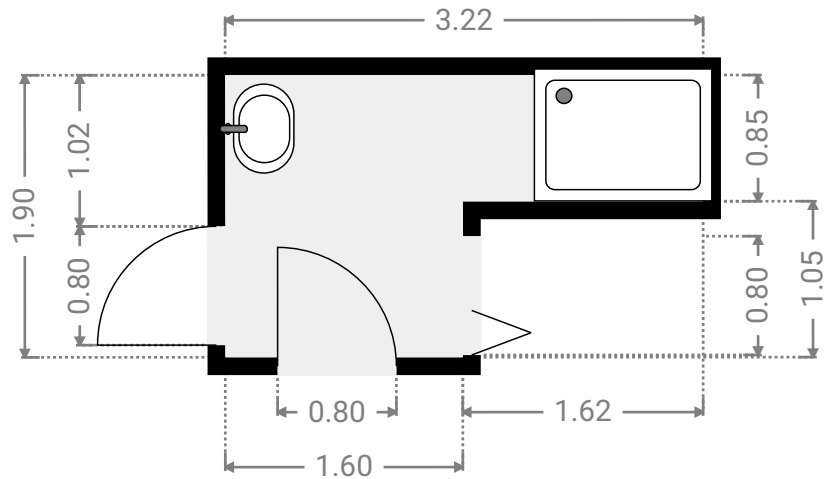
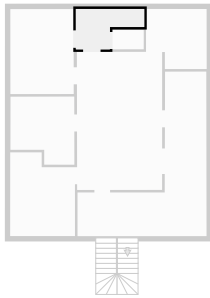

▼ **Bedroom**
1st Floor

WIDTH: 3.05 m • LENGTH: 3.94 m
AREA: 10.91 m² • PERIMETER: 13.98 m

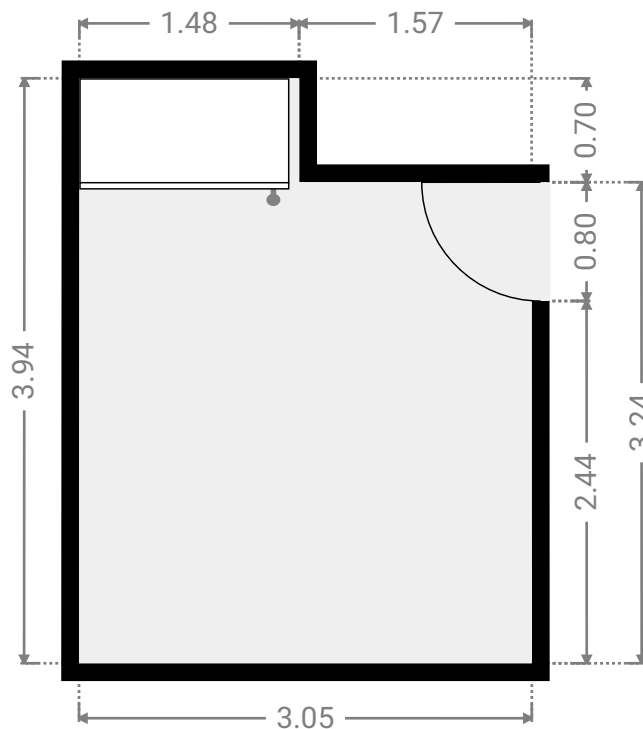
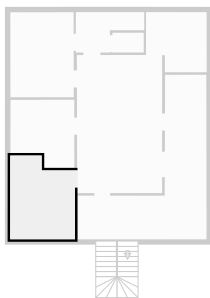

▼ Bedroom
1st Floor

WIDTH: 3.01 m • LENGTH: 3.21 m
AREA: 8.51 m² • PERIMETER: 12.42 m

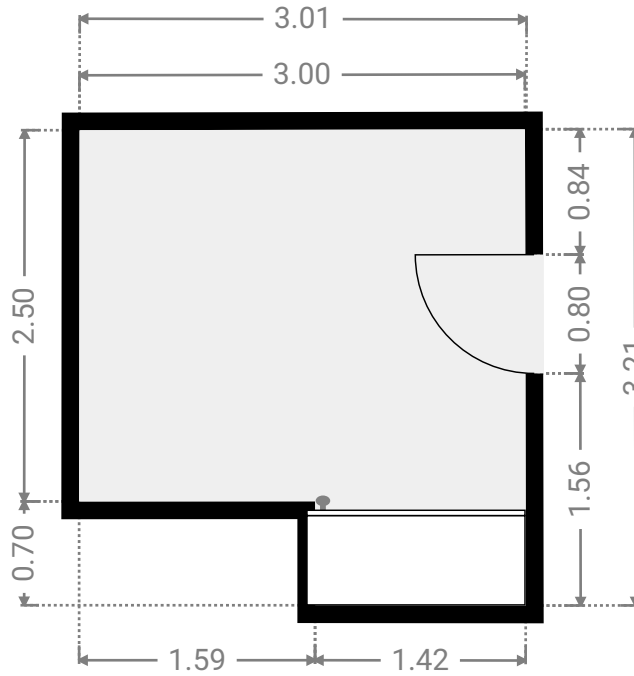
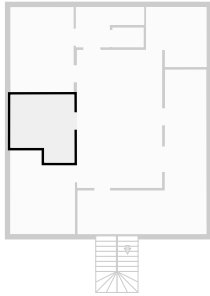

▼ Bedroom
1st Floor

WIDTH: 2.98 m • LENGTH: 4.00 m
AREA: 11.92 m² • PERIMETER: 13.96 m

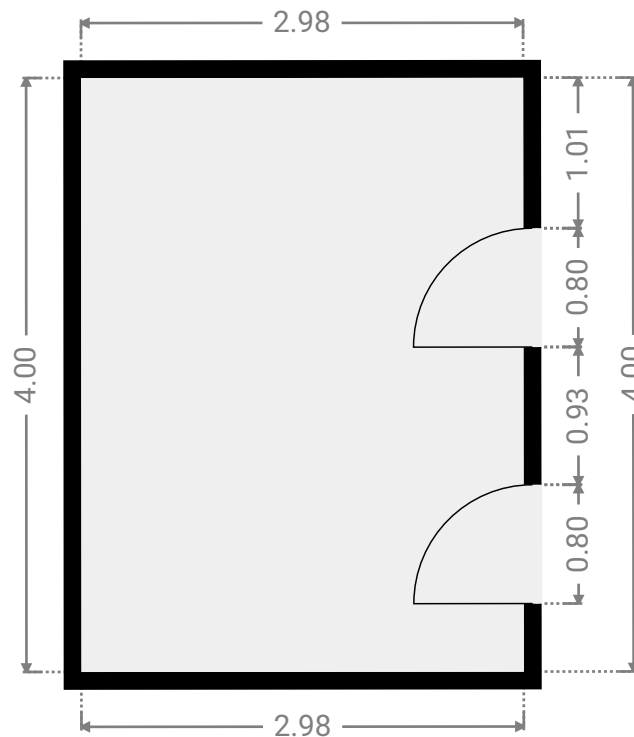
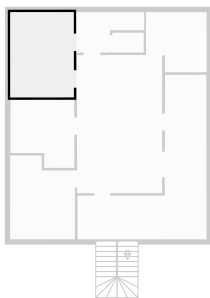

▼ **Kitchen**
1st Floor

WIDTH: 2.85 m • LENGTH: 2.83 m
AREA: 7.24 m² • PERIMETER: 11.36 m

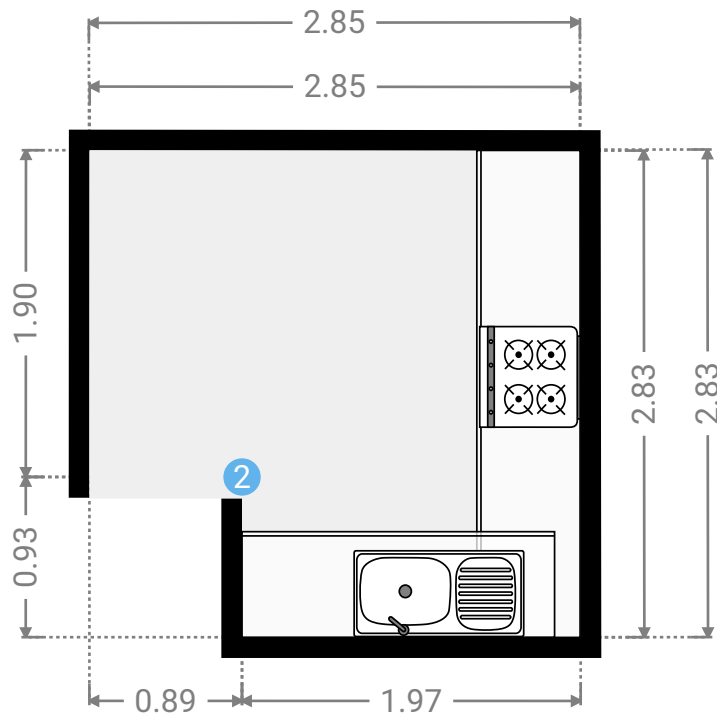
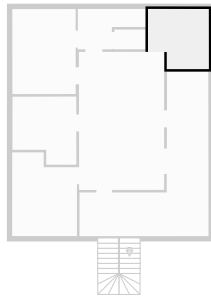

▼ **Kitchen/1st Floor**

2 OPENING

Height
0.00 m



▼ Living Room
1st Floor

WIDTH: 4.01 m • LENGTH: 6.50 m
AREA: 26.05 m² • PERIMETER: 21.02 m

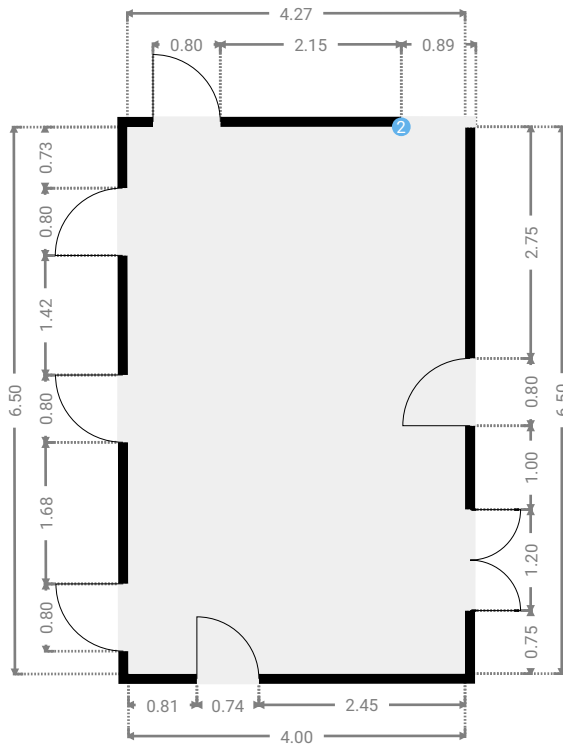
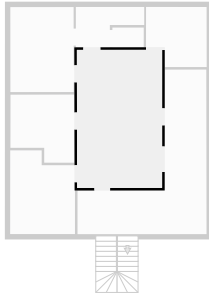

▼ Other
1st Floor

WIDTH: 6.07 m • LENGTH: 7.75 m
AREA: 23.59 m² • PERIMETER: 27.61 m

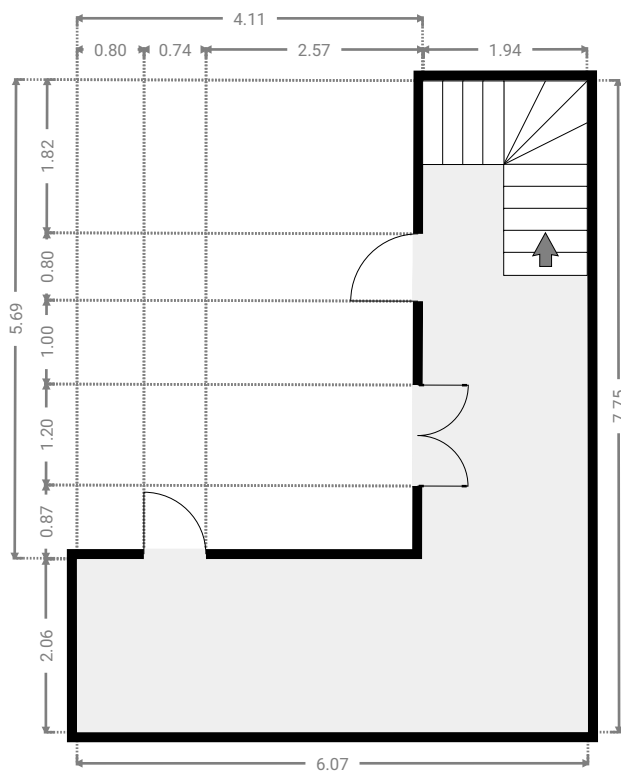
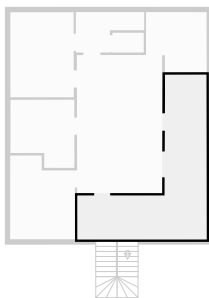

▼ Toilet
1st Floor

WIDTH: 1.48 m • LENGTH: 0.93 m
AREA: 1.37 m² • PERIMETER: 4.81 m

