

# 410 Thozet Road

**SUBMITTED BY**

Ray White Rockhampton Casey  
stockers@cqoz.com

---

**CREATED ON**

2022-07-04

---

**Floors**

2

---

▼ Ground Floor

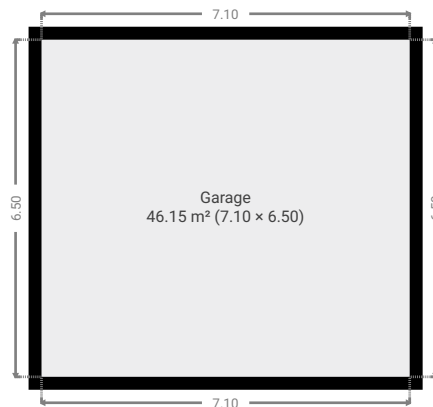
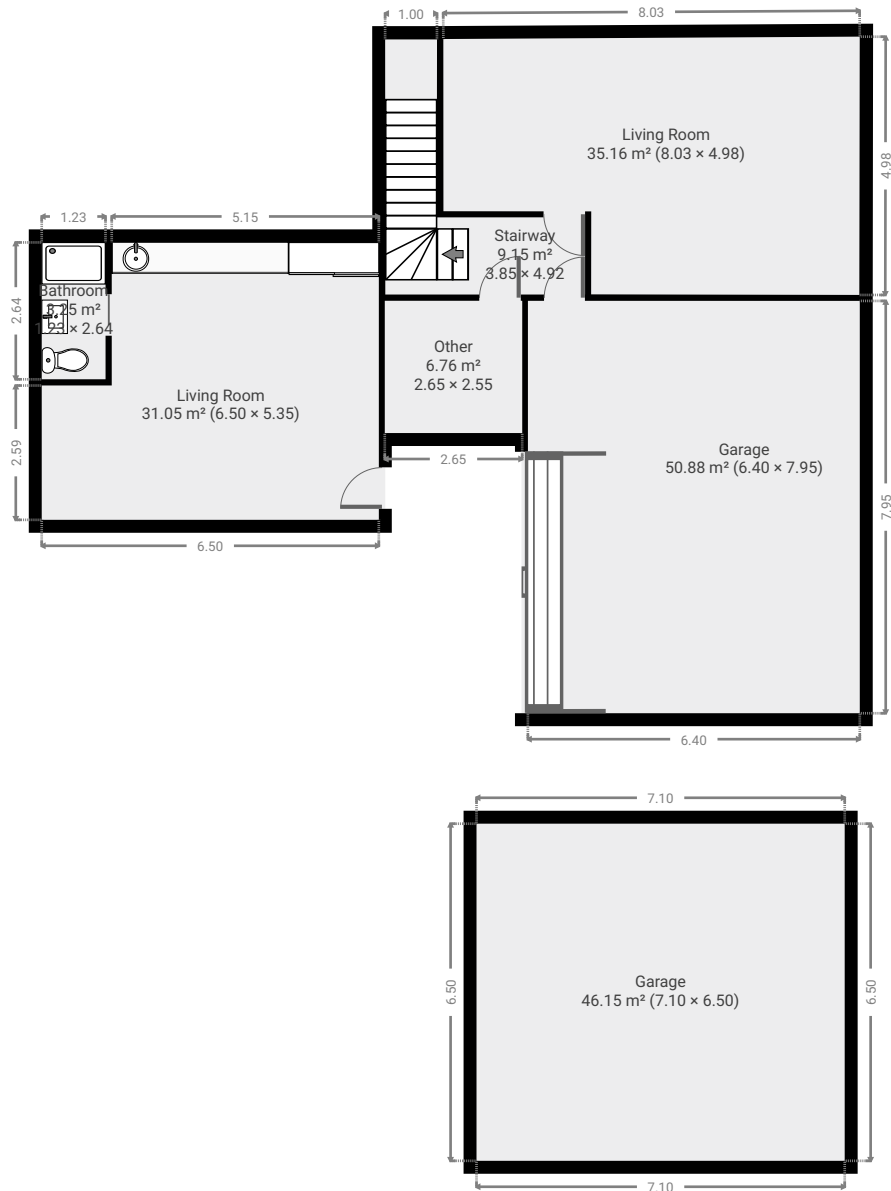

▼ **Bathroom**  
Ground Floor

WIDTH: 1.23 m • LENGTH: 2.64 m  
AREA: 3.25 m<sup>2</sup> • PERIMETER: 7.74 m

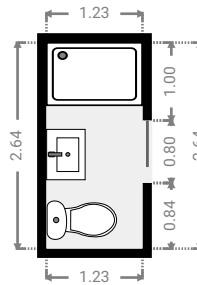
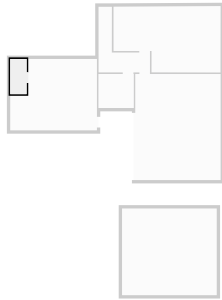

▼ **Garage**  
Ground Floor

WIDTH: 6.40 m • LENGTH: 7.95 m  
AREA: 50.88 m<sup>2</sup> • PERIMETER: 28.70 m

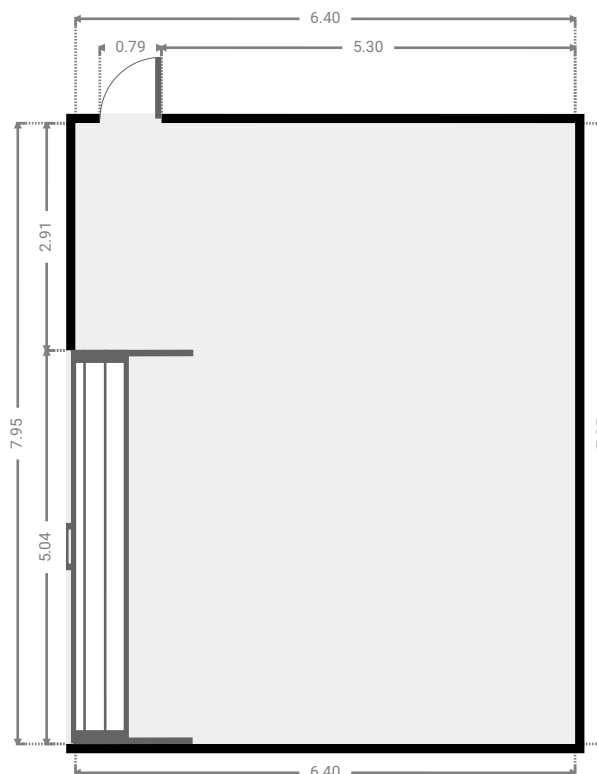
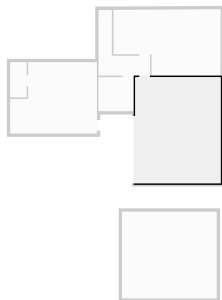

▼ **Garage**  
Ground Floor

WIDTH: 6.50 m • LENGTH: 7.10 m  
AREA: 46.15 m<sup>2</sup> • PERIMETER: 27.20 m

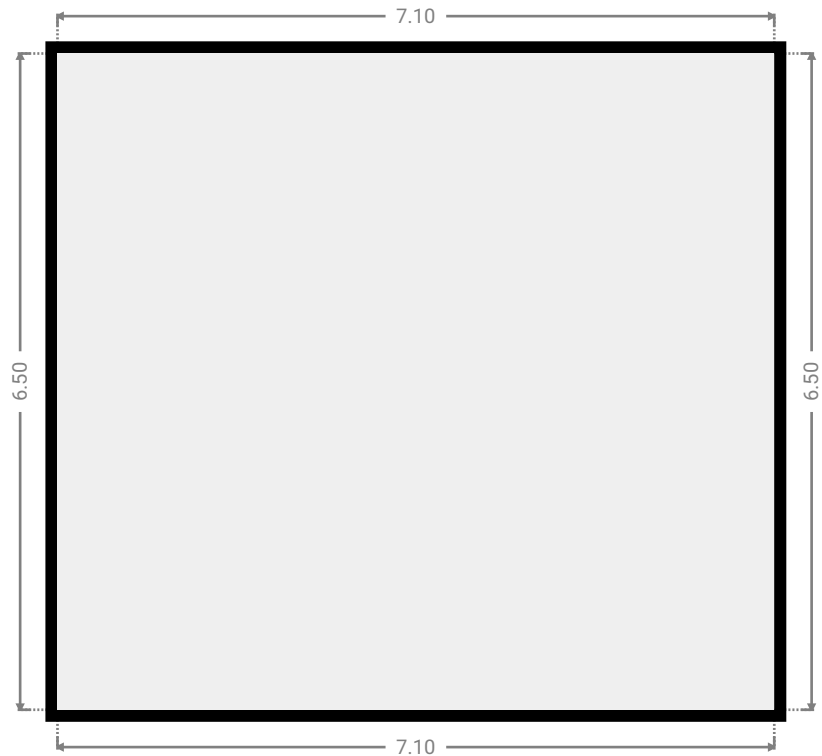
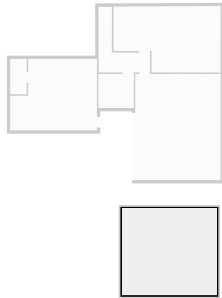

▼ **Living Room**  
Ground Floor

WIDTH: 8.03 m • LENGTH: 4.98 m  
AREA: 35.16 m<sup>2</sup> • PERIMETER: 25.95 m

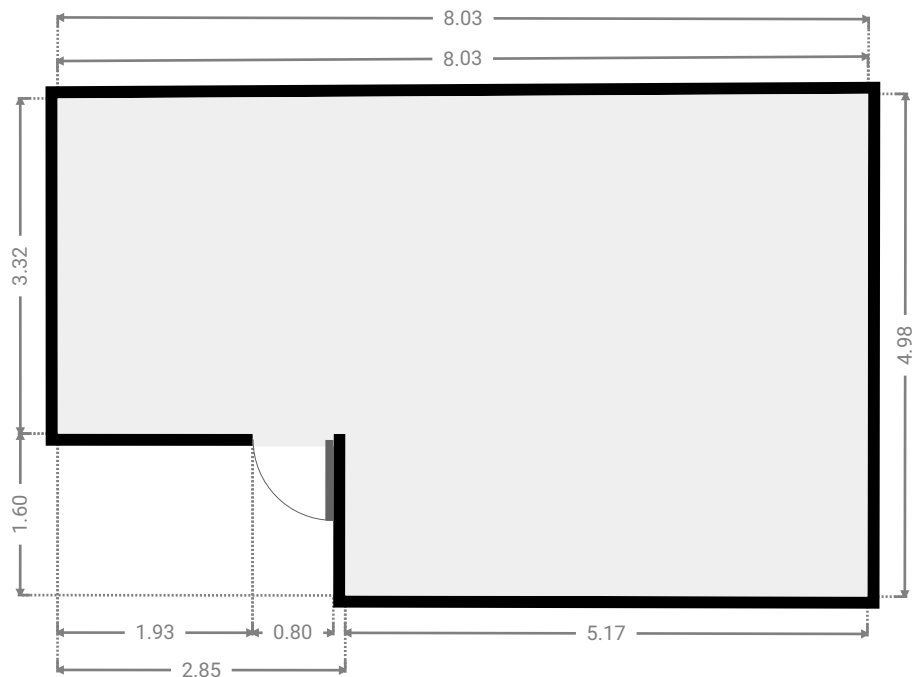
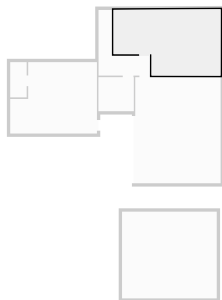

▼ **Living Room**  
Ground Floor

WIDTH: 6.50 m • LENGTH: 5.35 m  
AREA: 31.05 m<sup>2</sup> • PERIMETER: 23.70 m

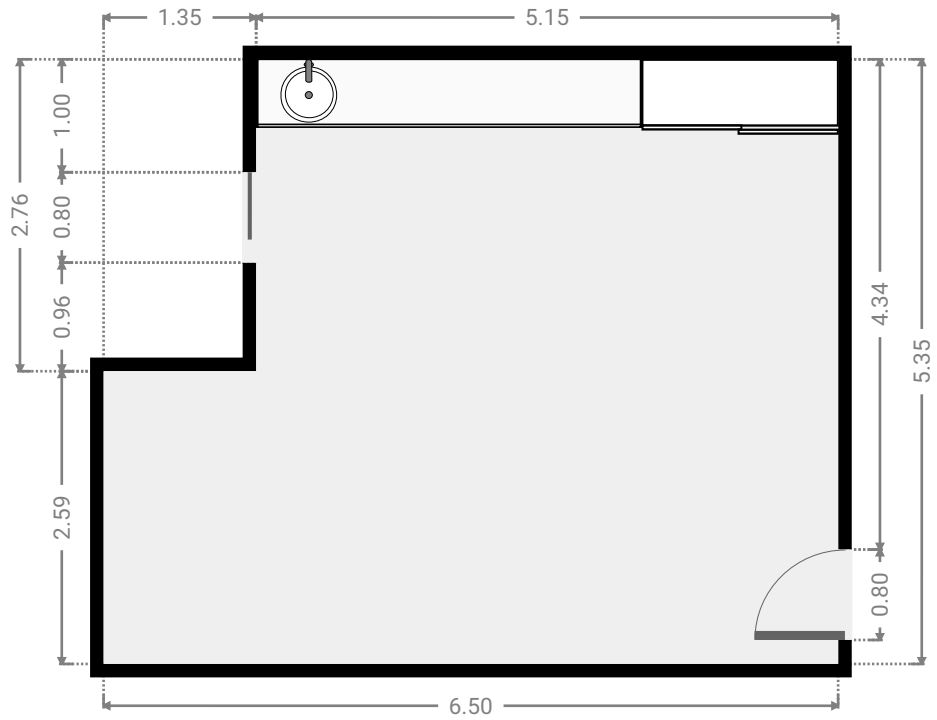
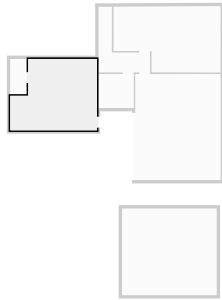

▼ **Other**  
Ground Floor

WIDTH: 2.65 m • LENGTH: 2.55 m  
AREA: 6.76 m<sup>2</sup> • PERIMETER: 10.40 m

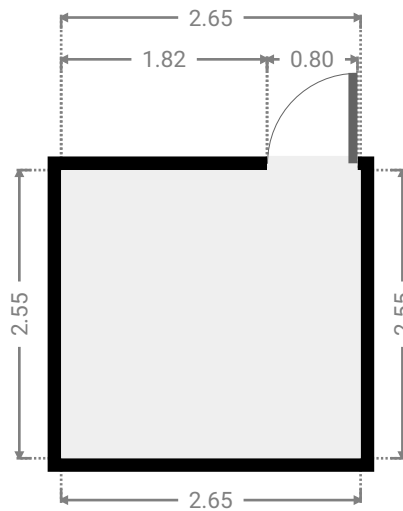
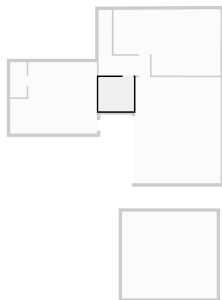

▼ **Stairway**  
Ground Floor

WIDTH: 3.85 m • LENGTH: 4.92 m  
AREA: 9.15 m<sup>2</sup> • PERIMETER: 17.55 m

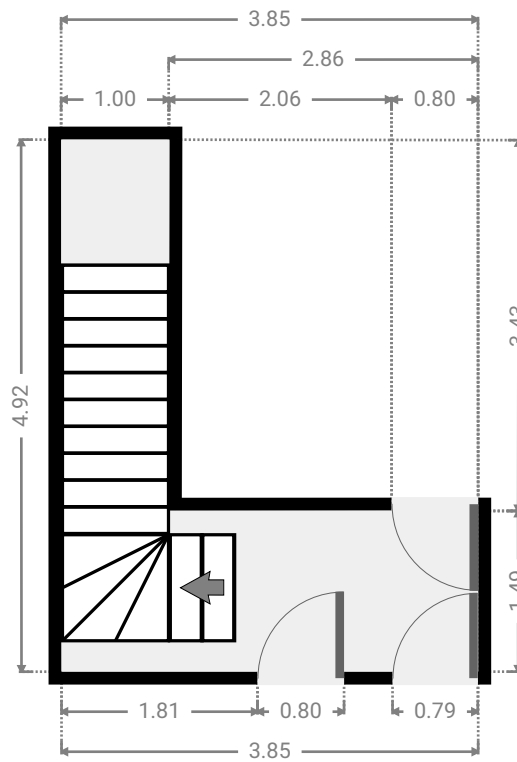
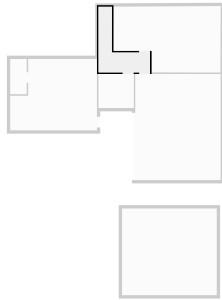

▼ 1st Floor

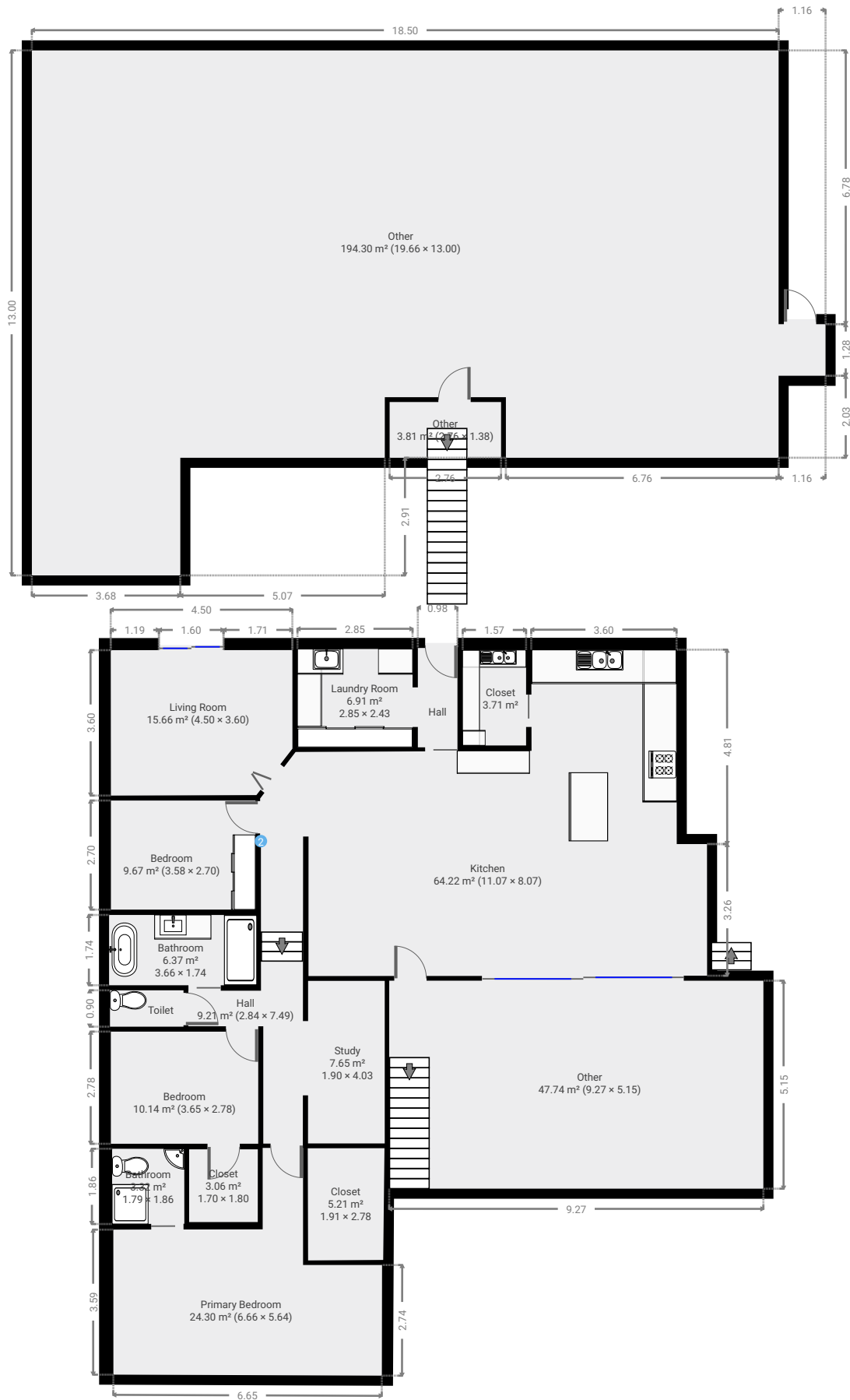

▼ Bathroom  
1st Floor

WIDTH: 3.66 m • LENGTH: 1.74 m  
AREA: 6.37 m<sup>2</sup> • PERIMETER: 10.80 m

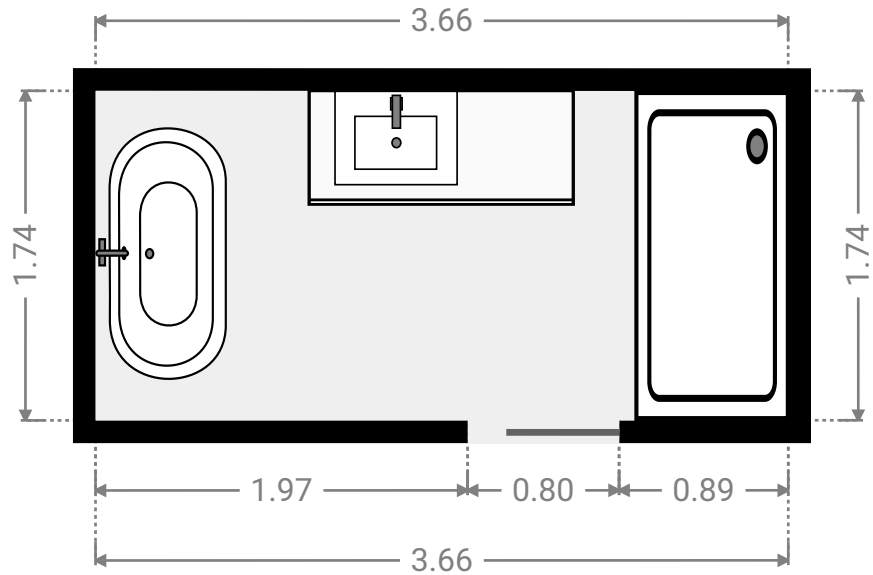
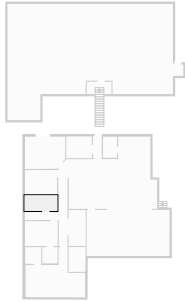

▼ Bathroom  
1st Floor

WIDTH: 1.79 m • LENGTH: 1.86 m  
AREA: 3.32 m<sup>2</sup> • PERIMETER: 7.29 m

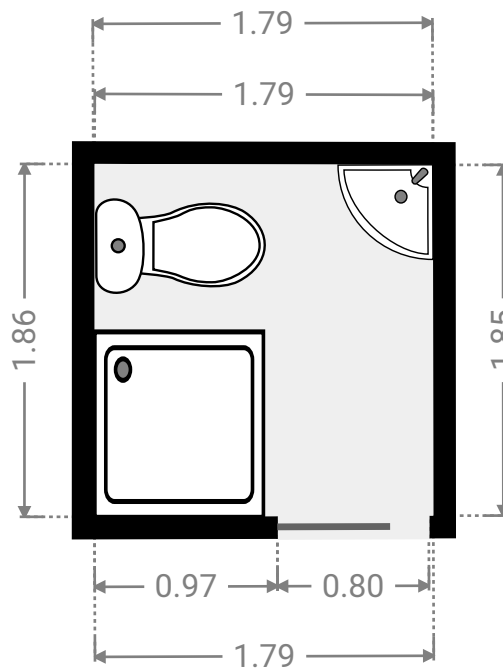
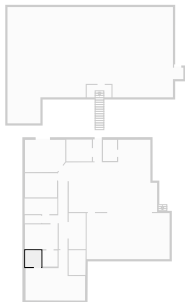



▼ **Bedroom**  
1st Floor

WIDTH: 3.58 m • LENGTH: 2.70 m  
AREA: 9.67 m<sup>2</sup> • PERIMETER: 12.56 m

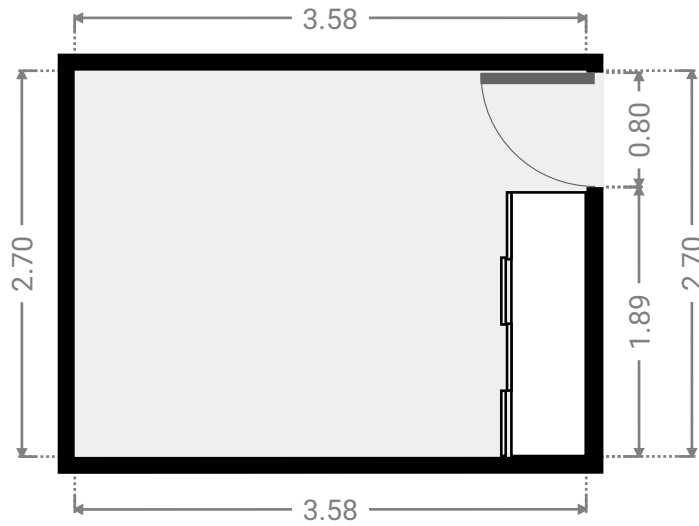
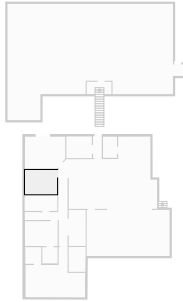

▼ **Bedroom**  
1st Floor

WIDTH: 3.65 m • LENGTH: 2.78 m  
AREA: 10.14 m<sup>2</sup> • PERIMETER: 12.86 m

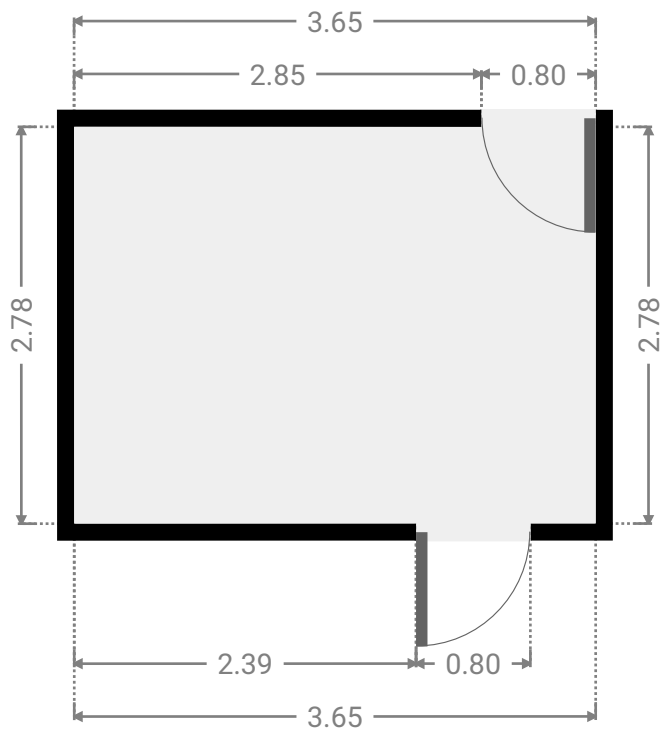
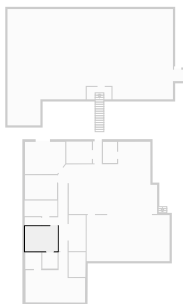

▼ **Closet**  
1st Floor

WIDTH: 1.70 m • LENGTH: 1.80 m  
AREA: 3.06 m<sup>2</sup> • PERIMETER: 7.00 m

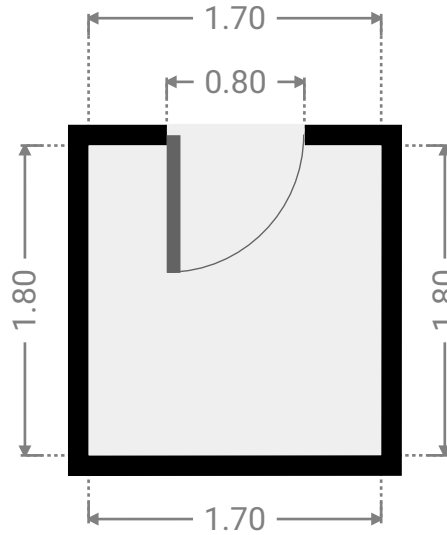
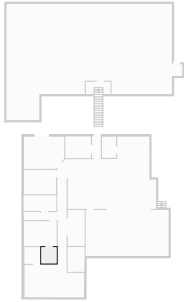

▼ **Closet**  
1st Floor

WIDTH: 1.91 m • LENGTH: 2.78 m  
AREA: 5.21 m<sup>2</sup> • PERIMETER: 9.30 m

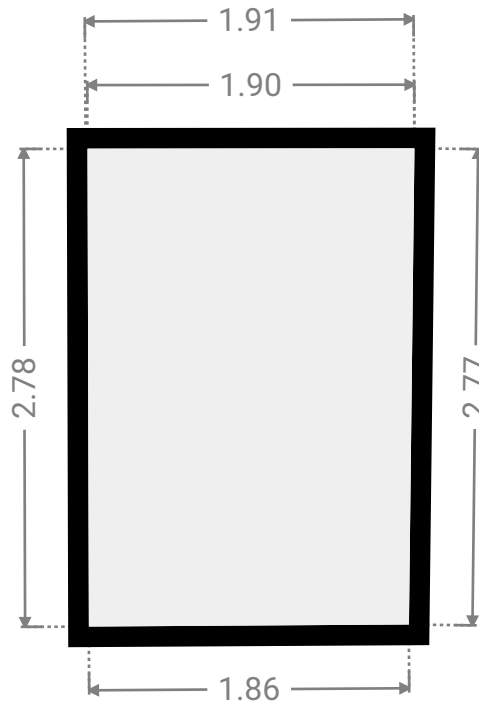
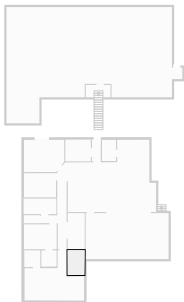

▼ **Hall**  
1st Floor

WIDTH: 0.98 m • LENGTH: 2.46 m  
AREA: 2.41 m<sup>2</sup> • PERIMETER: 6.88 m

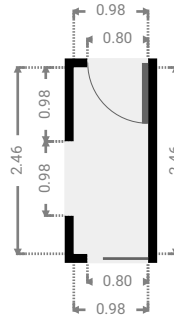
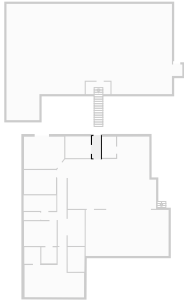

▼ **Hall**  
1st Floor

WIDTH: 2.84 m • LENGTH: 7.49 m  
AREA: 9.21 m<sup>2</sup> • PERIMETER: 20.66 m

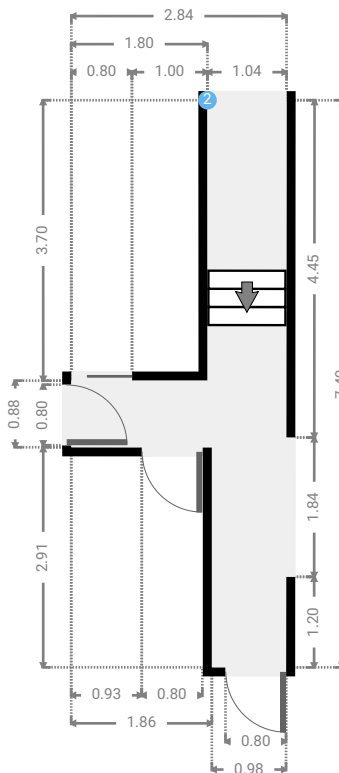
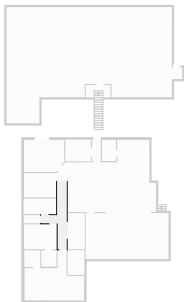

▼ Hall/1st Floor

2 OPENING

Height  
0.00 m



▼ **Kitchen**  
1st Floor

WIDTH: 11.07 m • LENGTH: 8.07 m  
AREA: 64.22 m<sup>2</sup> • PERIMETER: 37.69 m

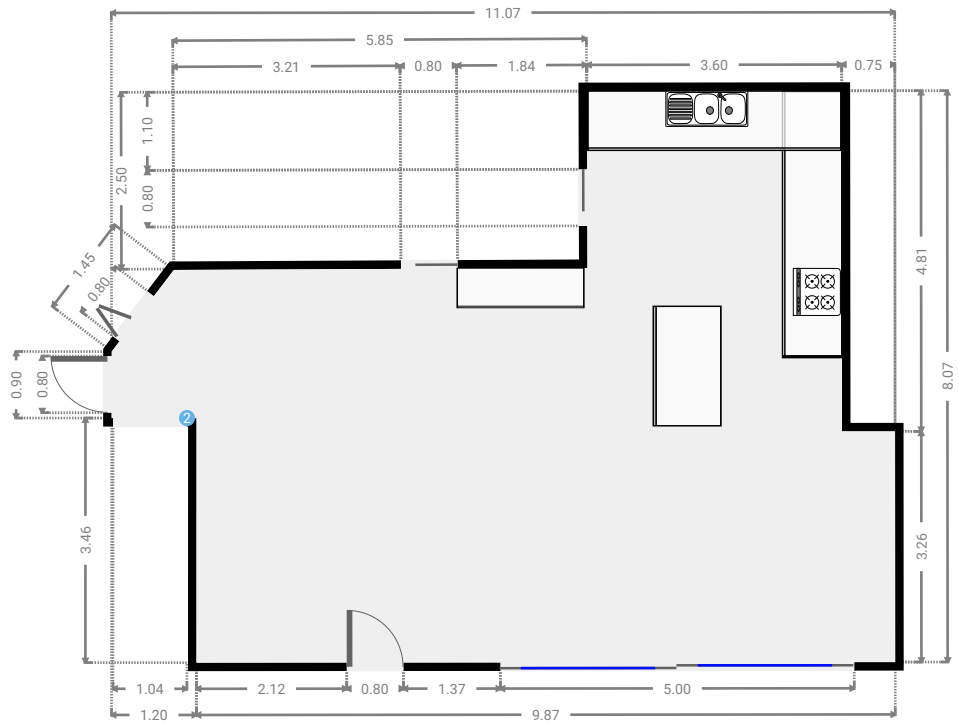
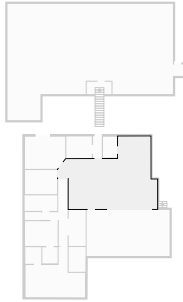

▼ **Closet**  
1st Floor

WIDTH: 1.57 m • LENGTH: 2.36 m  
AREA: 3.71 m<sup>2</sup> • PERIMETER: 7.86 m

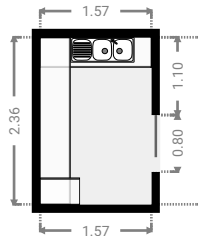
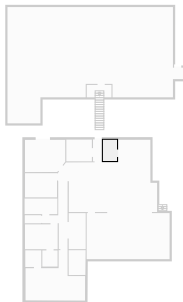

▼ **Laundry Room**  
1st Floor

WIDTH: 2.85 m • LENGTH: 2.43 m  
AREA: 6.91 m<sup>2</sup> • PERIMETER: 10.55 m

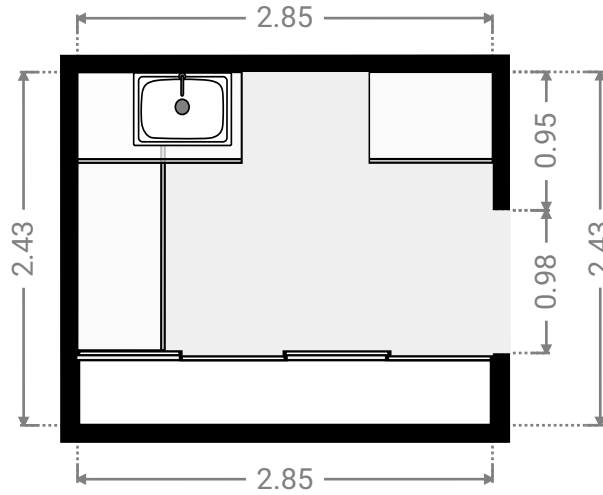
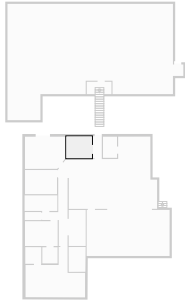

▼ **Living Room**  
1st Floor

WIDTH: 4.50 m • LENGTH: 3.60 m  
AREA: 15.66 m<sup>2</sup> • PERIMETER: 15.60 m

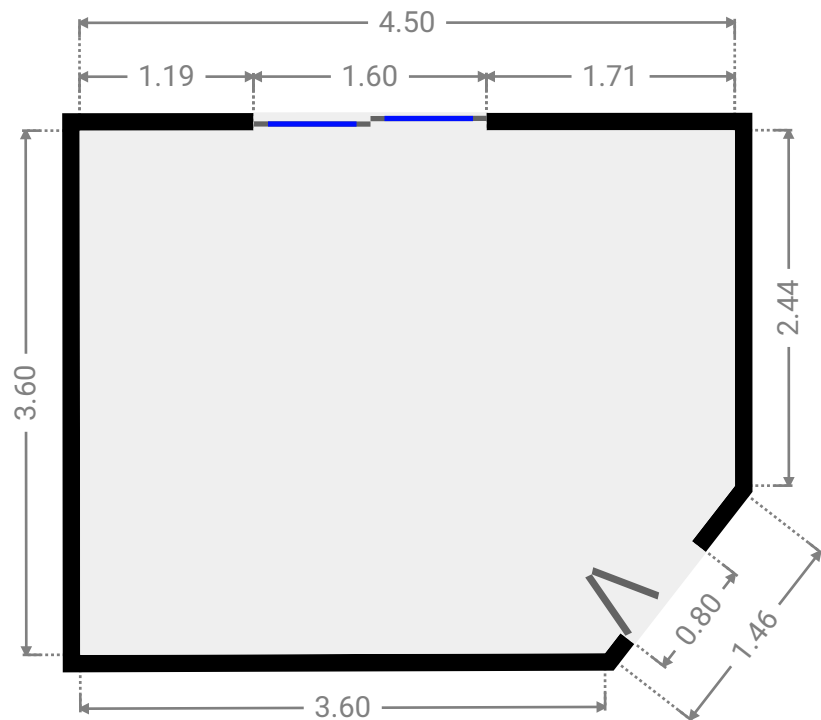
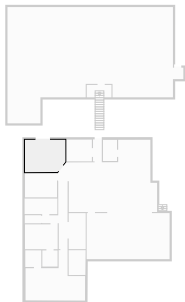

▼ Other  
1st Floor

WIDTH: 9.27 m • LENGTH: 5.15 m  
AREA: 47.74 m<sup>2</sup> • PERIMETER: 28.84 m

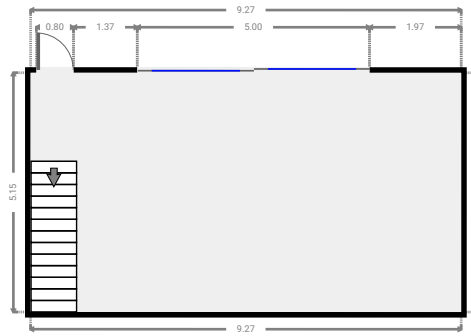
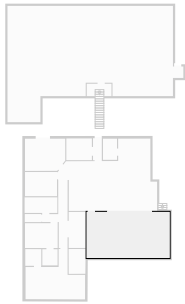

▼ Other  
1st Floor

WIDTH: 19.66 m • LENGTH: 13.00 m  
AREA: 194.30 m<sup>2</sup> • PERIMETER: 68.33 m

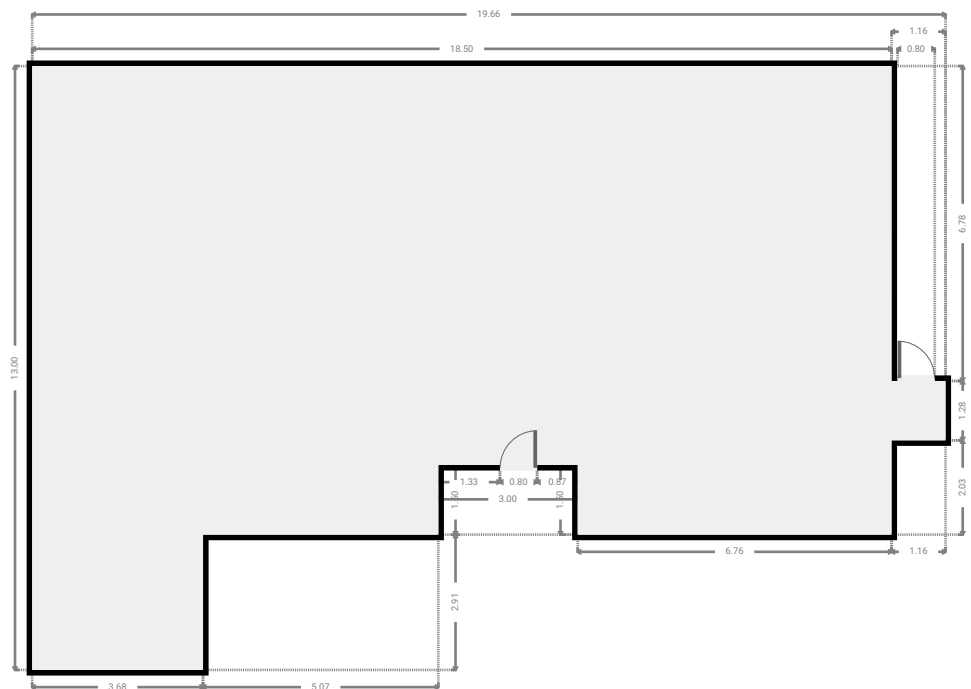
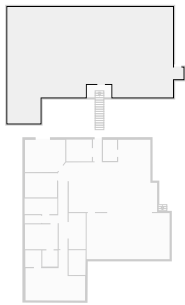

▼ **Other**  
1st Floor

WIDTH: 2.76 m • LENGTH: 1.38 m  
AREA: 3.81 m<sup>2</sup> • PERIMETER: 8.28 m

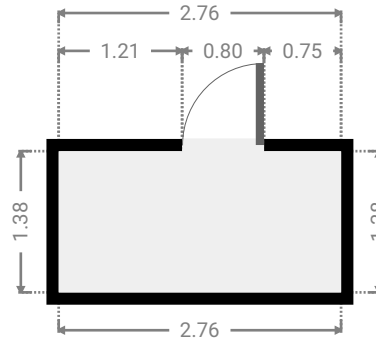
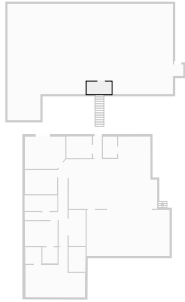

▼ **Primary Bedroom**  
1st Floor

WIDTH: 6.66 m • LENGTH: 5.64 m  
AREA: 24.30 m<sup>2</sup> • PERIMETER: 24.55 m

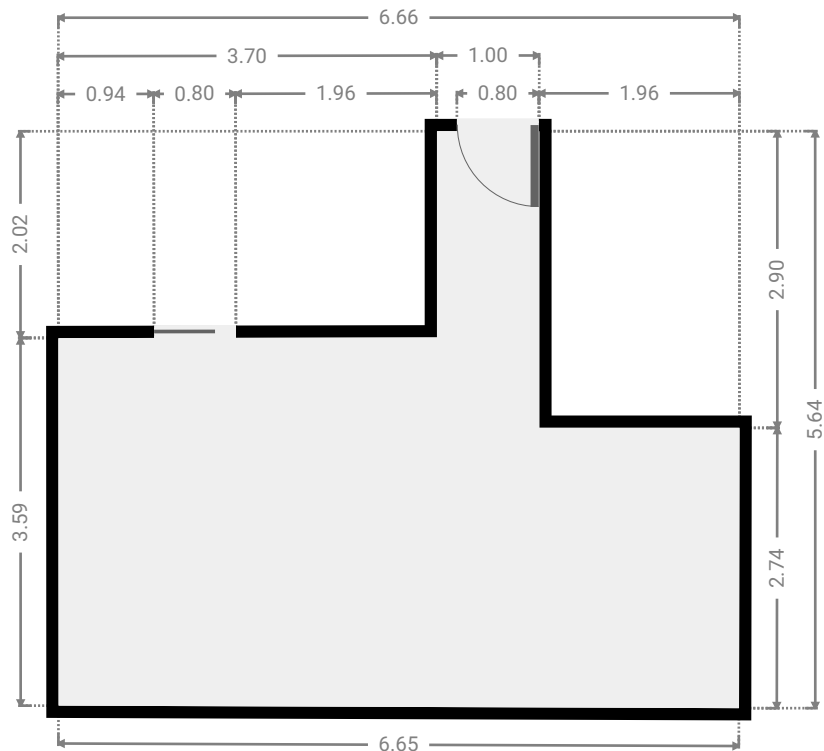
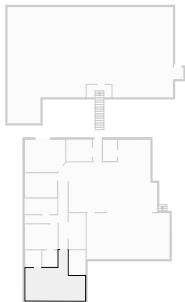



▼ **Study**  
1st Floor

WIDTH: 1.90 m • LENGTH: 4.03 m  
AREA: 7.65 m<sup>2</sup> • PERIMETER: 11.85 m

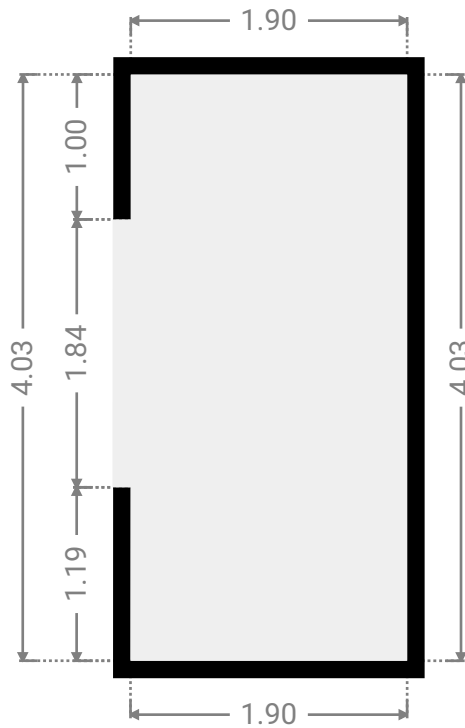
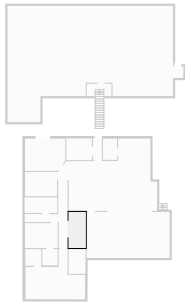

▼ **Toilet**  
1st Floor

WIDTH: 1.82 m • LENGTH: 0.90 m  
AREA: 1.64 m<sup>2</sup> • PERIMETER: 5.44 m

