

41 Ingram Drive

Ground Floor

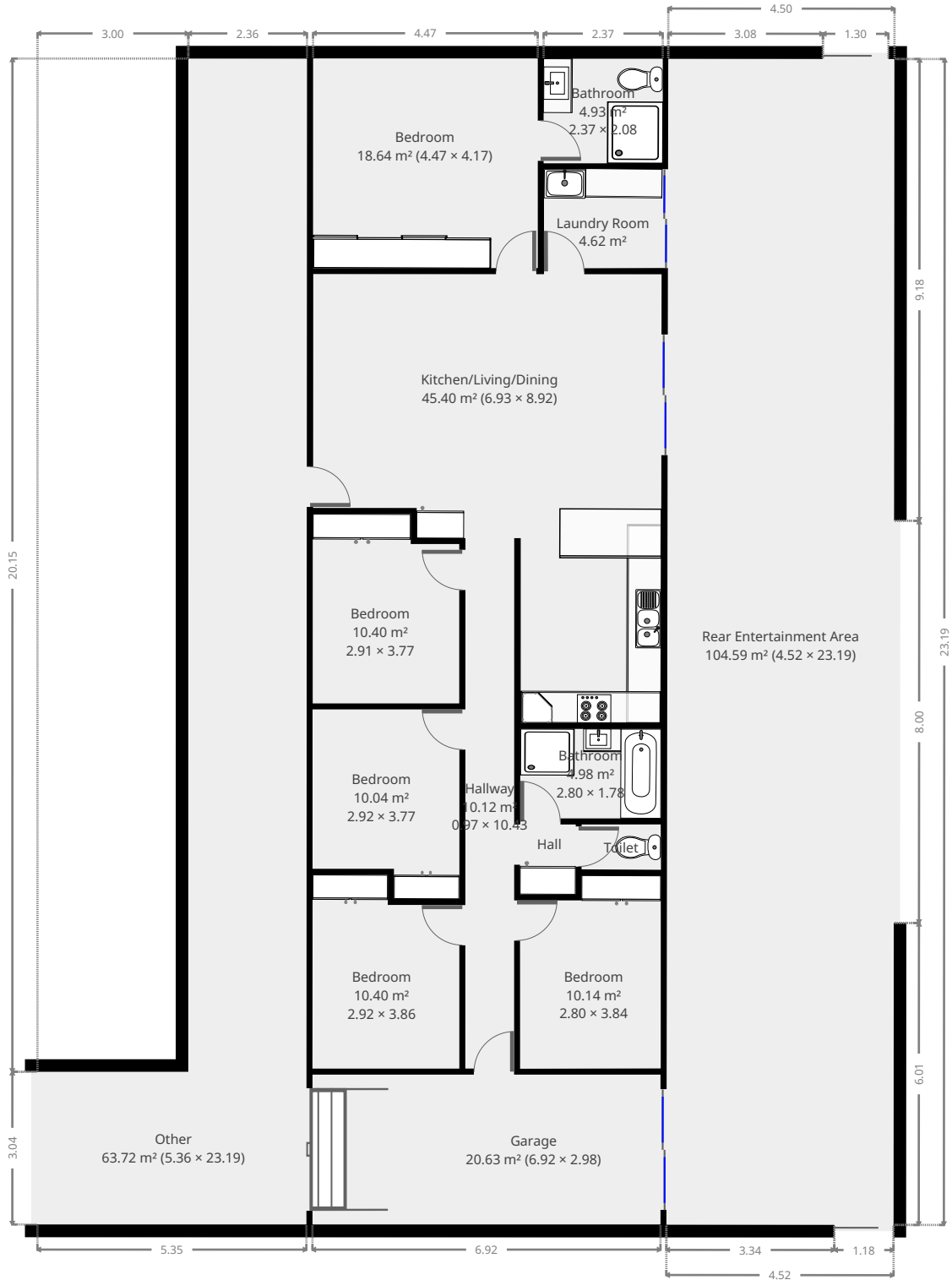

THIS FLOORPLAN IS PROVIDED WITHOUT WARRANTY OF ANY KIND. SENSOPIA DISCLAIMS ANY WARRANTY INCLUDING, WITHOUT LIMITATION, SATISFACTORY QUALITY OR ACCURACY OF DIMENSIONS.



41 Ingram Drive

Kitchen/Living/Dining

Width: 6.93 m
 Length: 8.92 m
 Area: 45.40 m²
 Perimeter: 31.69 m

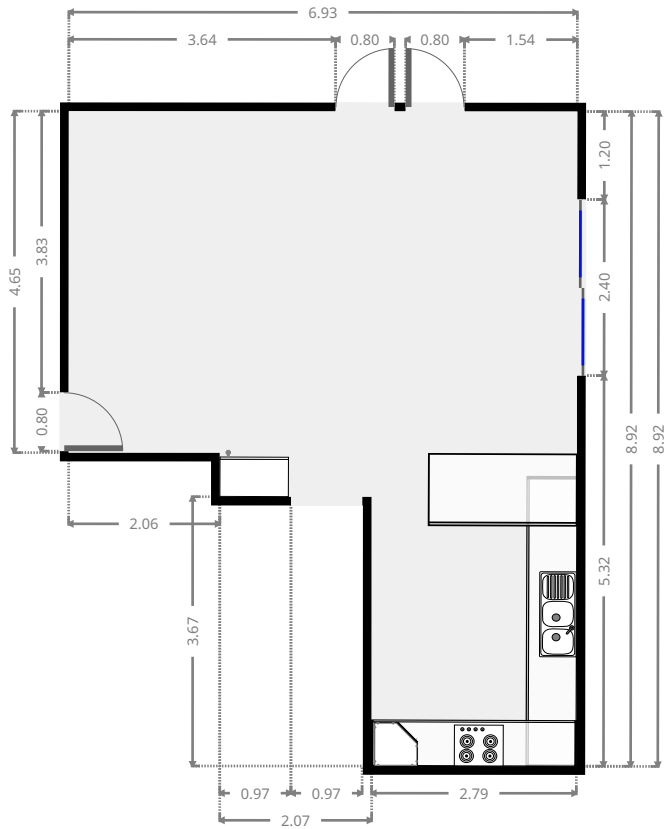
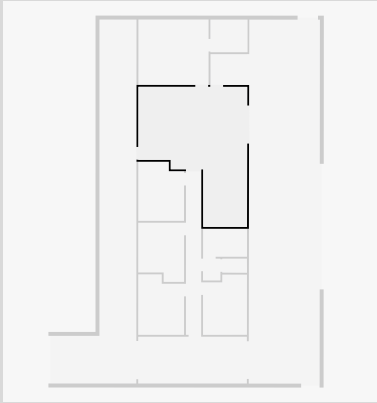

Bedroom

Width: 4.17 m
 Length: 4.47 m
 Area: 18.64 m²
 Perimeter: 17.28 m

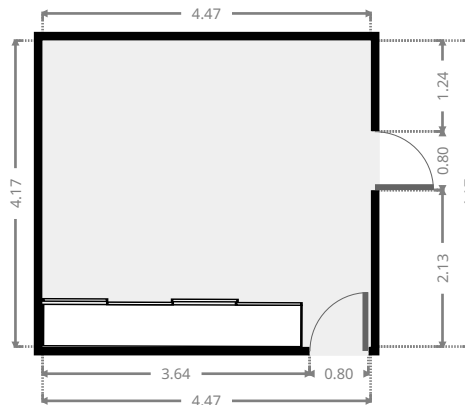
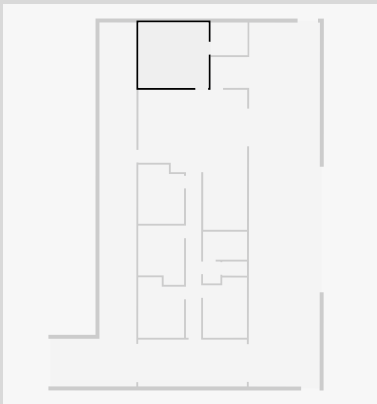

41 Ingram Drive

Bathroom

Width: 2.08 m
 Length: 2.37 m
 Area: 4.93 m²
 Perimeter: 8.90 m

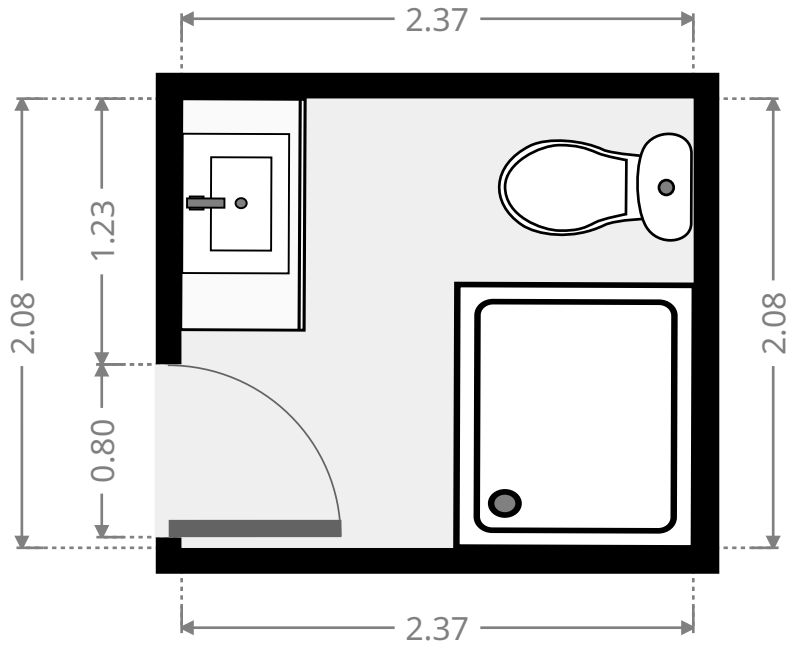
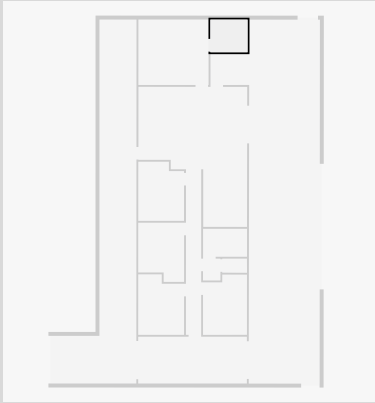

Laundry Room

Width: 1.98 m
 Length: 2.35 m
 Area: 4.62 m²
 Perimeter: 8.63 m

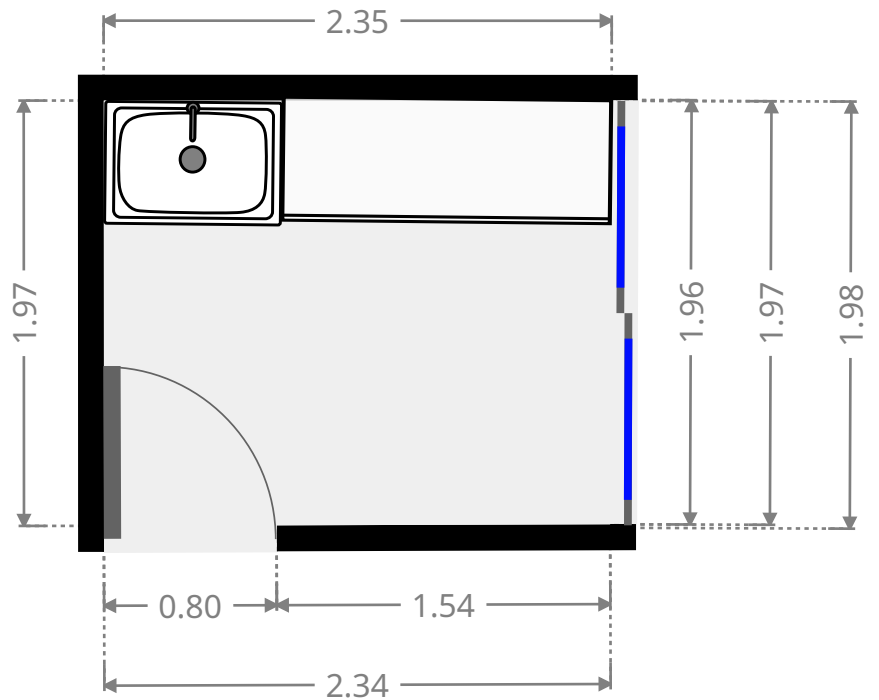
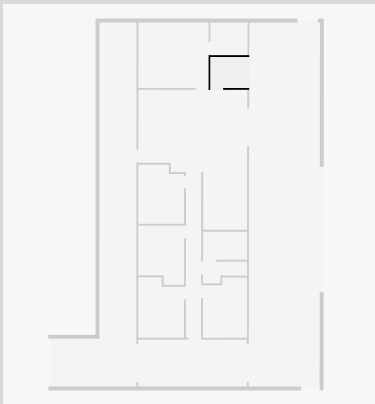

THIS FLOORPLAN IS PROVIDED WITHOUT WARRANTY OF ANY KIND. SENSOPIA DISCLAIMS ANY WARRANTY INCLUDING, WITHOUT LIMITATION, SATISFACTORY QUALITY OR ACCURACY OF DIMENSIONS.

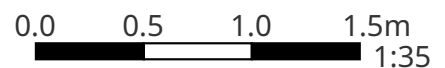

41 Ingram Drive

Hallway

Width: 0.97 m
 Length: 10.43 m
 Area: 10.12 m²
 Perimeter: 22.80 m

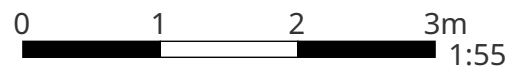
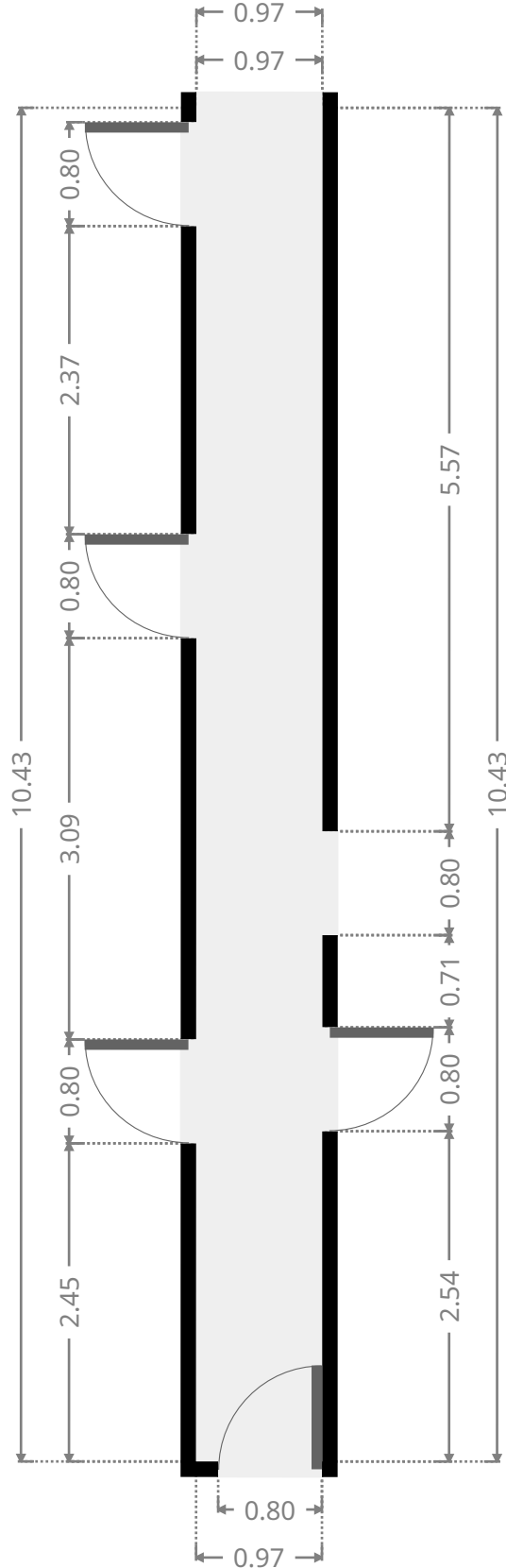
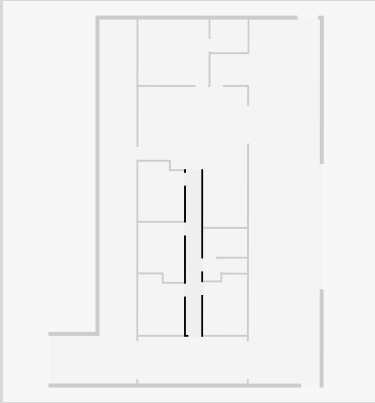

THIS FLOORPLAN IS PROVIDED WITHOUT WARRANTY OF ANY KIND. SENSOPIA DISCLAIMS ANY WARRANTY INCLUDING, WITHOUT LIMITATION, SATISFACTORY QUALITY OR ACCURACY OF DIMENSIONS.

41 Ingram Drive

Bedroom

Width: 2.91 m
 Length: 3.77 m
 Area: 10.40 m²
 Perimeter: 13.36 m

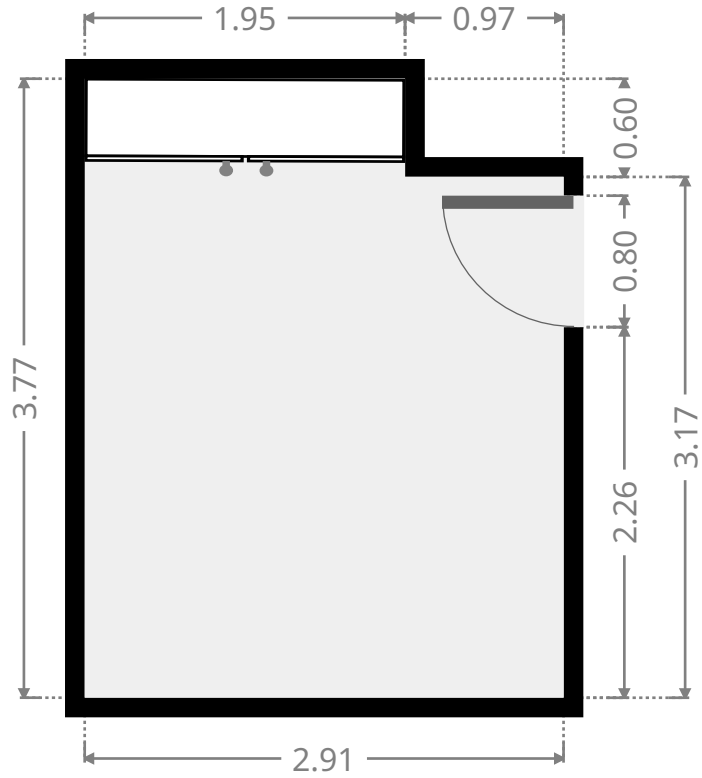
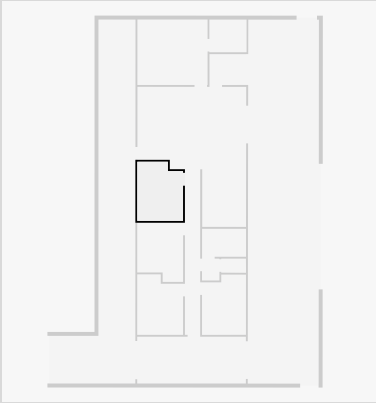

Bedroom

Width: 2.92 m
 Length: 3.77 m
 Area: 10.04 m²
 Perimeter: 13.38 m

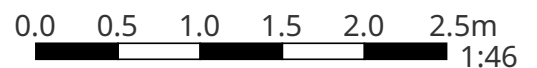
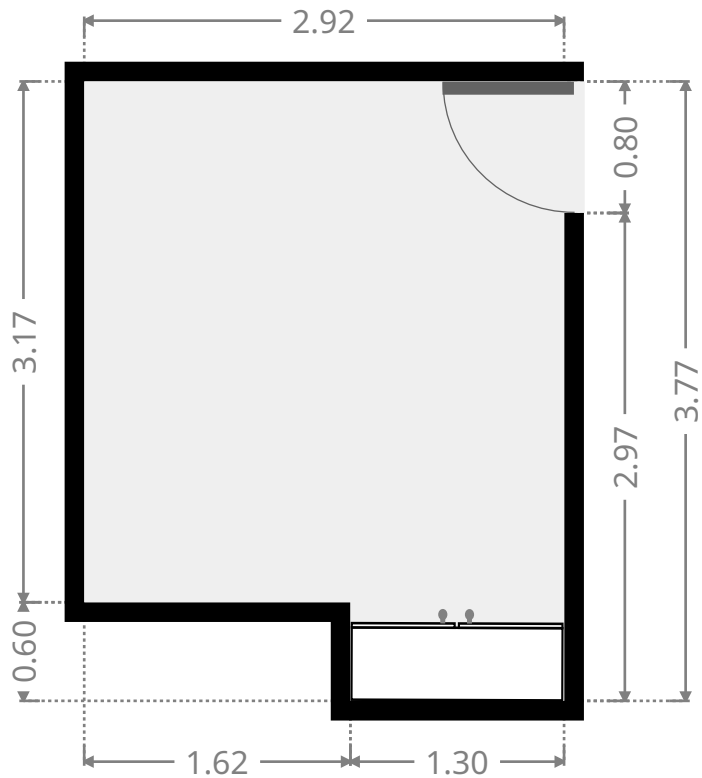
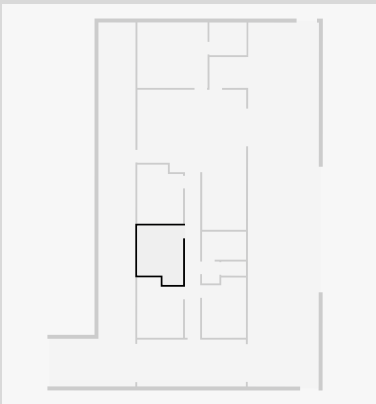

THIS FLOORPLAN IS PROVIDED WITHOUT WARRANTY OF ANY KIND. SENSOPIA DISCLAIMS ANY WARRANTY INCLUDING, WITHOUT LIMITATION, SATISFACTORY QUALITY OR ACCURACY OF DIMENSIONS.

41 Ingram Drive

Bedroom

Width: 2.92 m
Length: 3.86 m
Area: 10.40 m²
Perimeter: 13.55 m

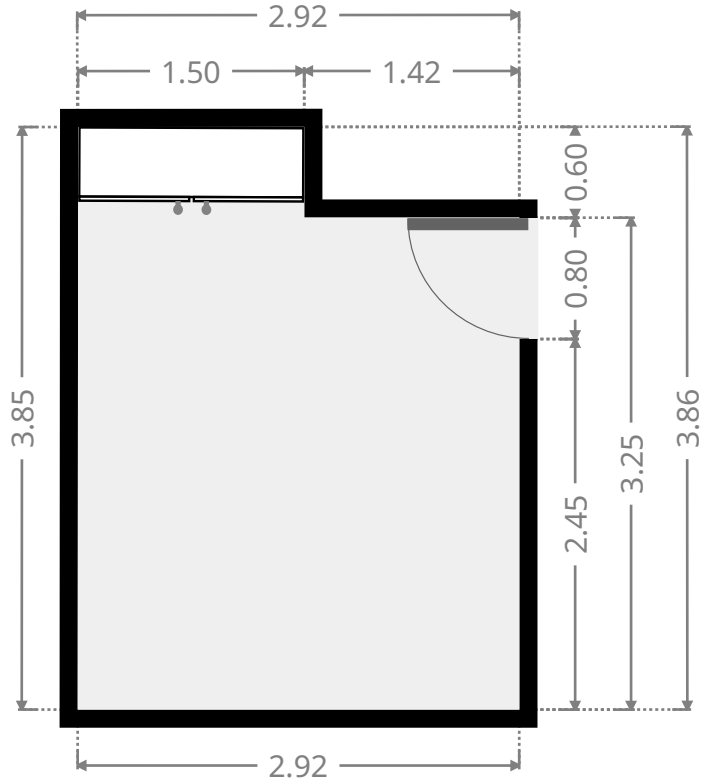
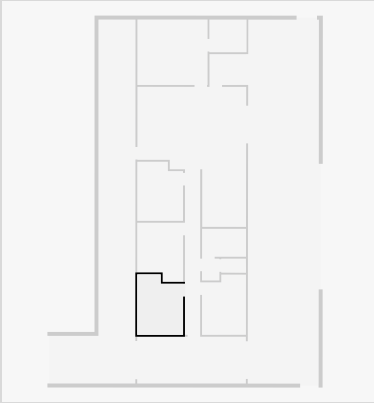

Bathroom

Width: 1.78 m
Length: 2.80 m
Area: 4.98 m²
Perimeter: 9.16 m

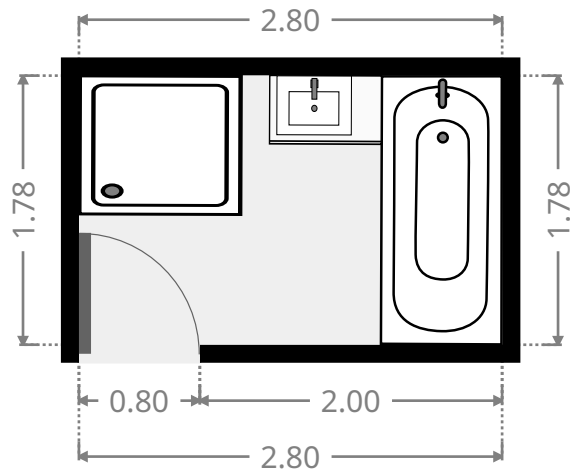
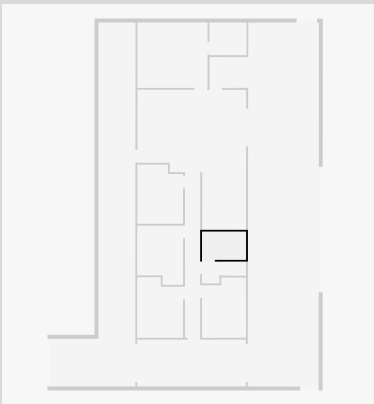

41 Ingram Drive

Hall

Width: 1.11 m
Length: 1.39 m
Area: 1.54 m²
Perimeter: 5.00 m

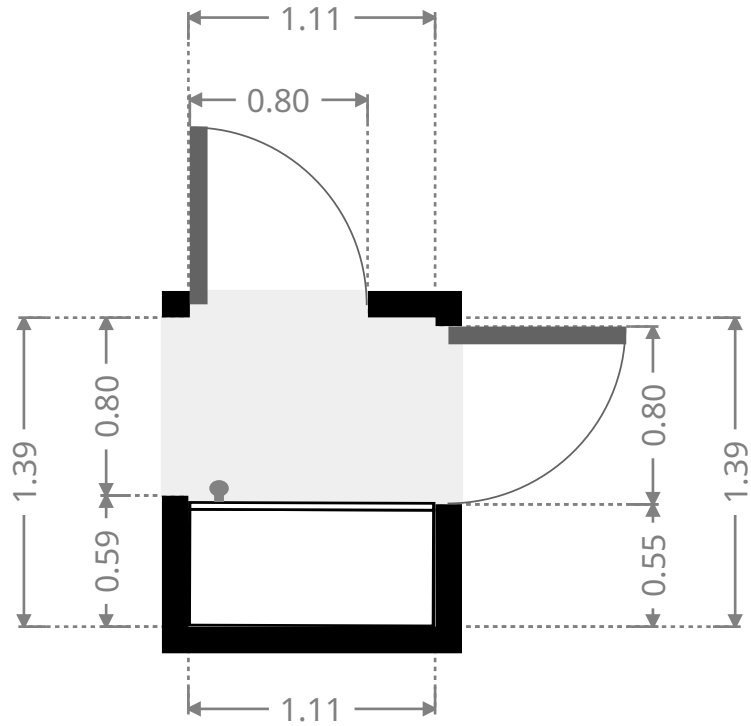
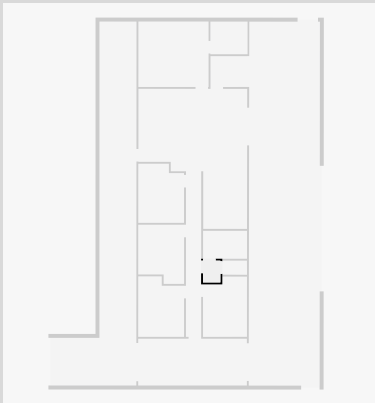

Toilet / Half Bath

Width: 0.90 m
Length: 1.58 m
Area: 1.41 m²
Perimeter: 4.95 m

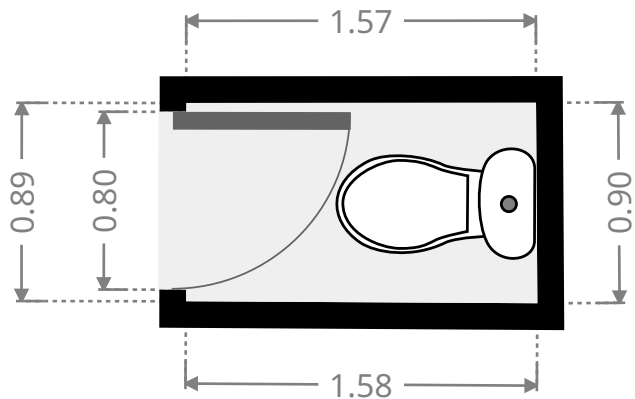
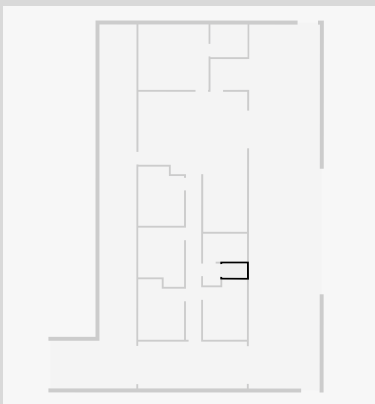

41 Ingram Drive

Bedroom

Width: 2.80 m
Length: 3.84 m
Area: 10.14 m²
Perimeter: 13.27 m

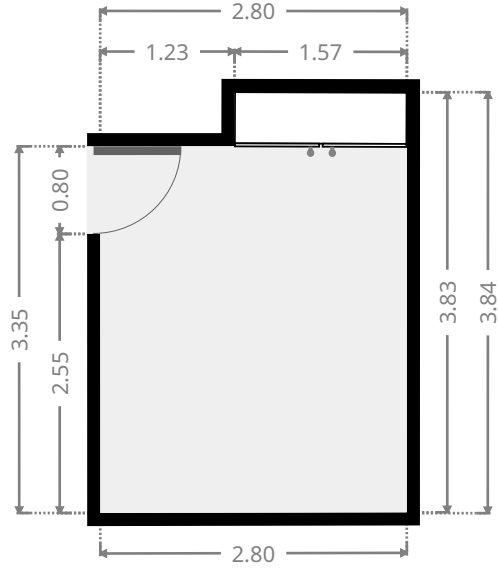
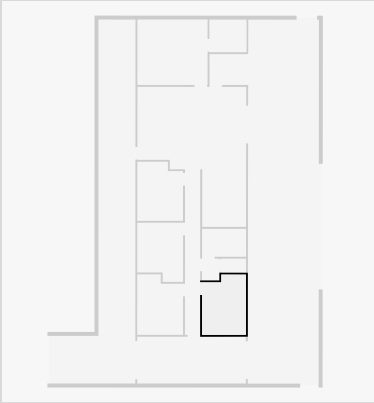

Garage

Width: 2.98 m
Length: 6.92 m
Area: 20.63 m²
Perimeter: 19.81 m

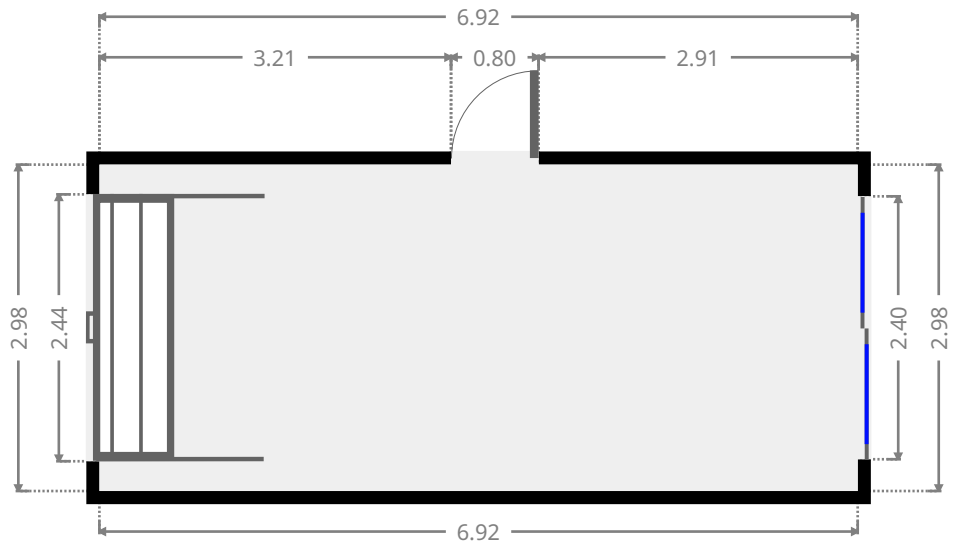
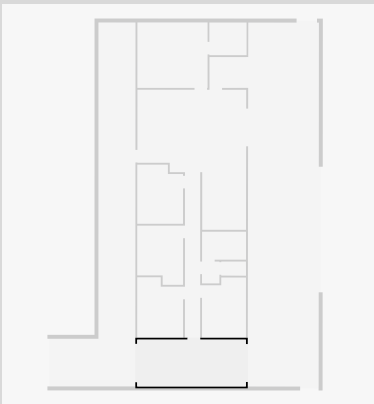

41 Ingram Drive

Rear Entertainment Area

Width: 4.52 m
Length: 23.19 m
Area: 104.59 m²
Perimeter: 55.40 m

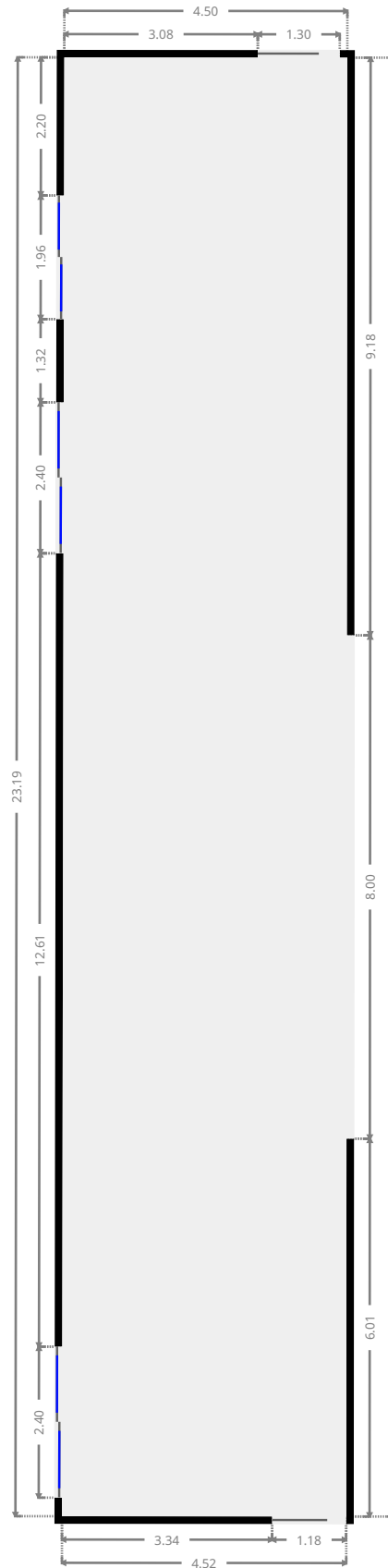
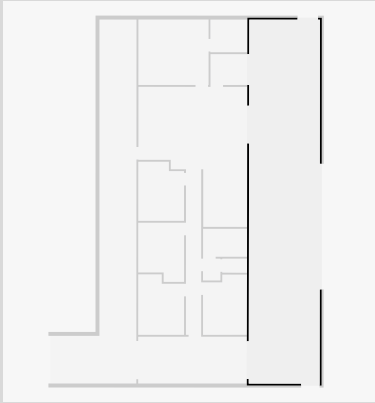

THIS FLOORPLAN IS PROVIDED WITHOUT WARRANTY OF ANY KIND. SENSOPIA DISCLAIMS ANY WARRANTY INCLUDING, WITHOUT LIMITATION, SATISFACTORY QUALITY OR ACCURACY OF DIMENSIONS.

41 Ingram Drive

Other

Width: 5.36 m
Length: 23.19 m
Area: 63.72 m²
Perimeter: 57.09 m

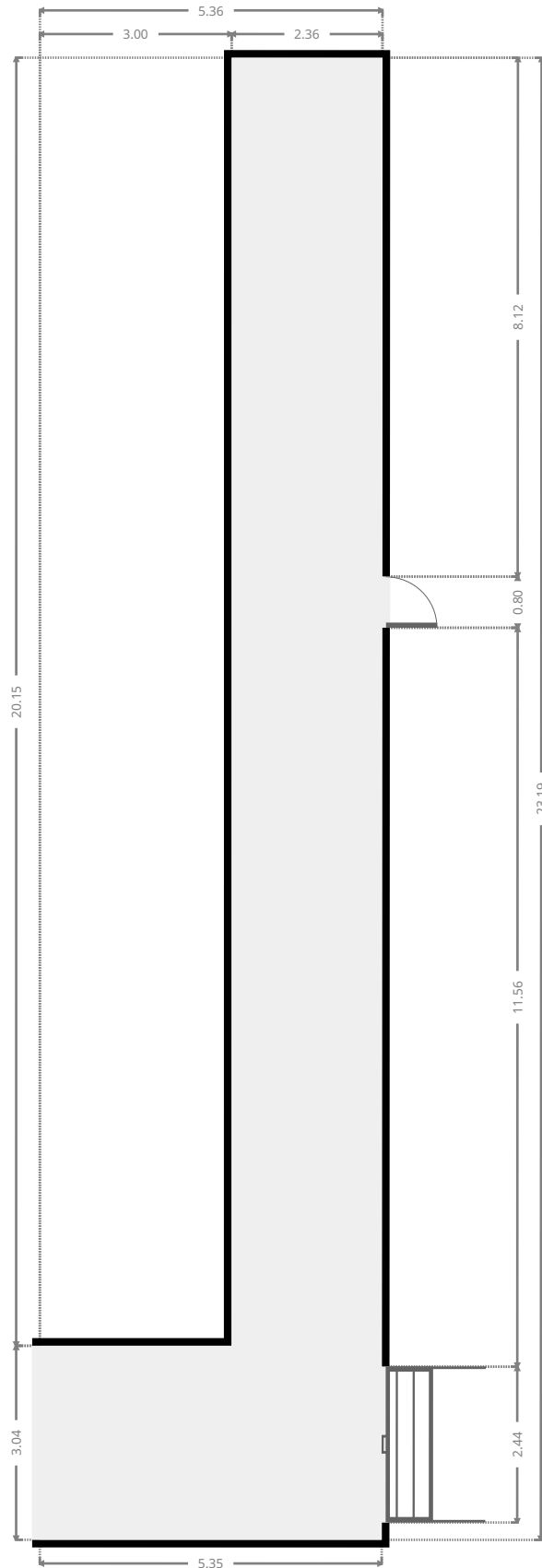
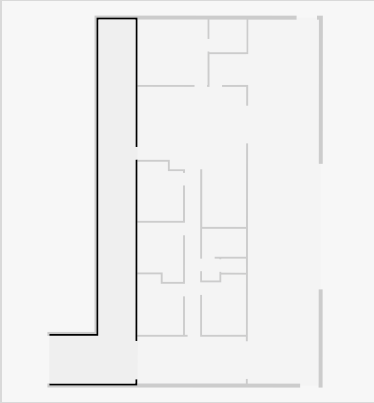

THIS FLOORPLAN IS PROVIDED WITHOUT WARRANTY OF ANY KIND. SENSOPIA DISCLAIMS ANY WARRANTY INCLUDING, WITHOUT LIMITATION, SATISFACTORY QUALITY OR ACCURACY OF DIMENSIONS.

0 2 4 6m
1:109