

403 Stenhouse Street

Ground Floor

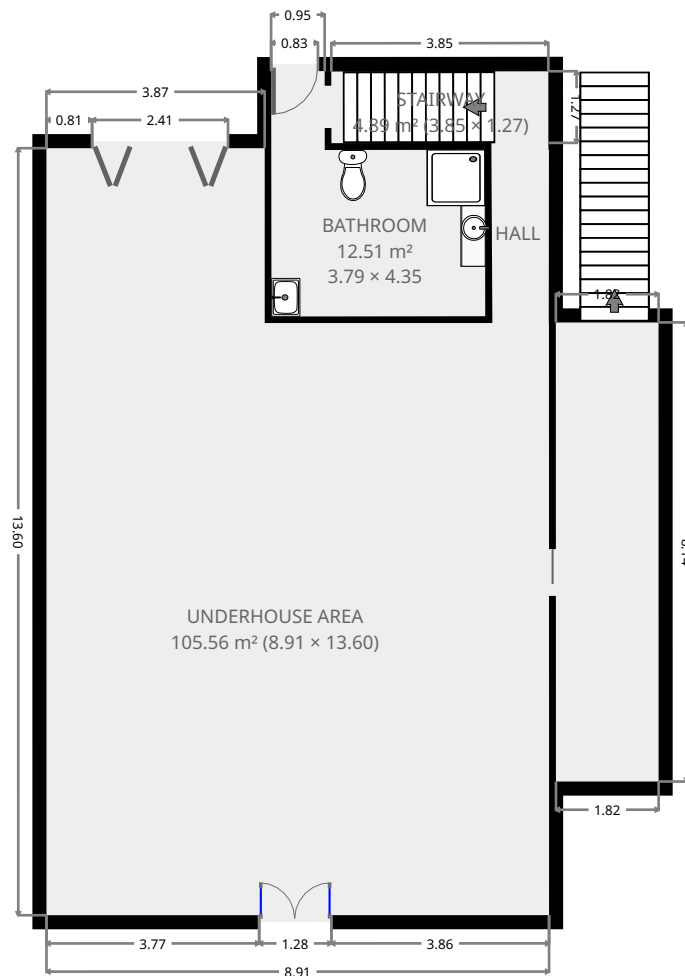

THIS FLOORPLAN IS PROVIDED WITHOUT WARRANTY OF ANY KIND. SENSOPIA DISCLAIMS ANY WARRANTY INCLUDING, WITHOUT LIMITATION, SATISFACTORY QUALITY OR ACCURACY OF DIMENSIONS.

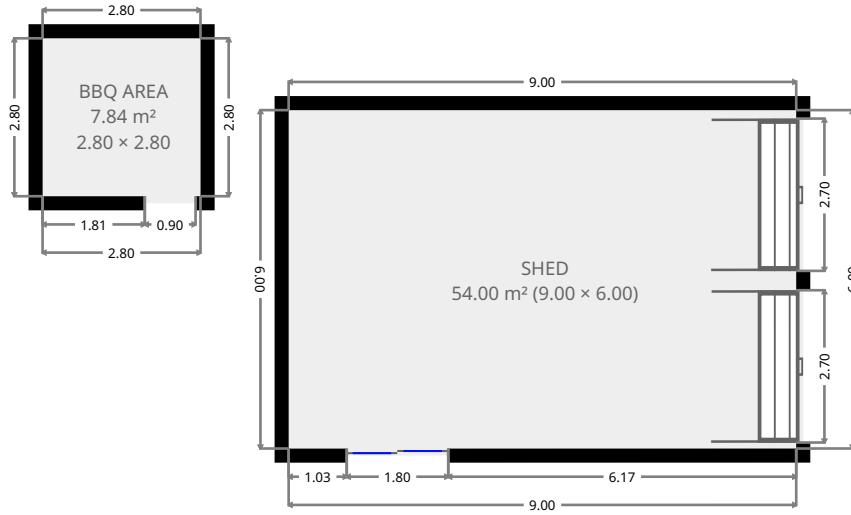

403 Stenhouse Street

Underhouse Area

Width: 8.91 m
Length: 13.60 m
Area: 105.56 m²
Perimeter: 45.02 m

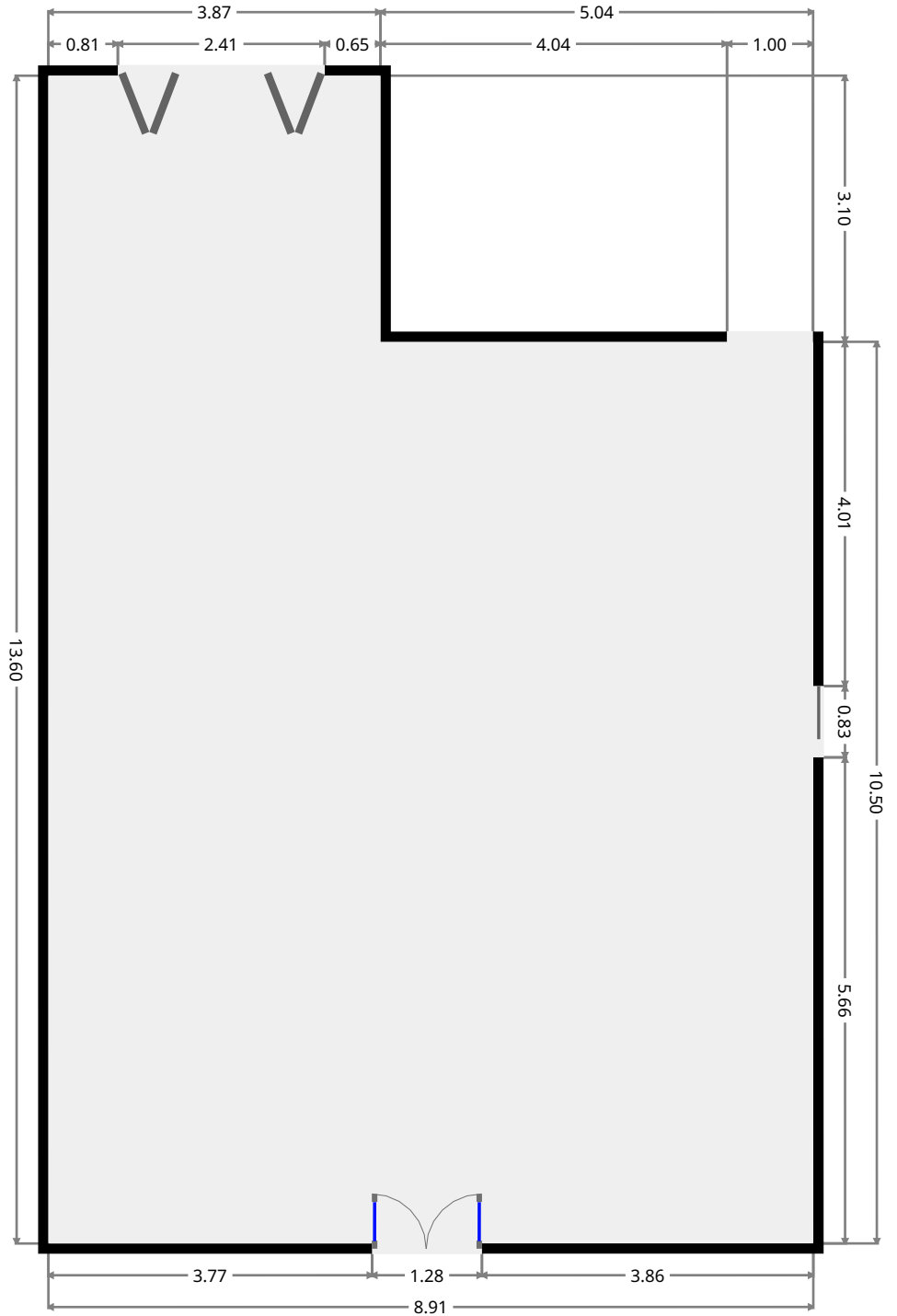
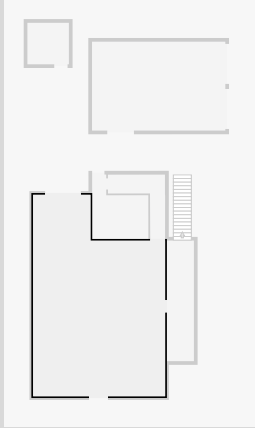

THIS FLOORPLAN IS PROVIDED WITHOUT WARRANTY OF ANY KIND. SENSOPIA DISCLAIMS ANY WARRANTY INCLUDING, WITHOUT LIMITATION, SATISFACTORY QUALITY OR ACCURACY OF DIMENSIONS.



403 Stenhouse Street

Bathroom

Width: 3.79 m
 Length: 4.35 m
 Area: 12.51 m²
 Perimeter: 16.28 m

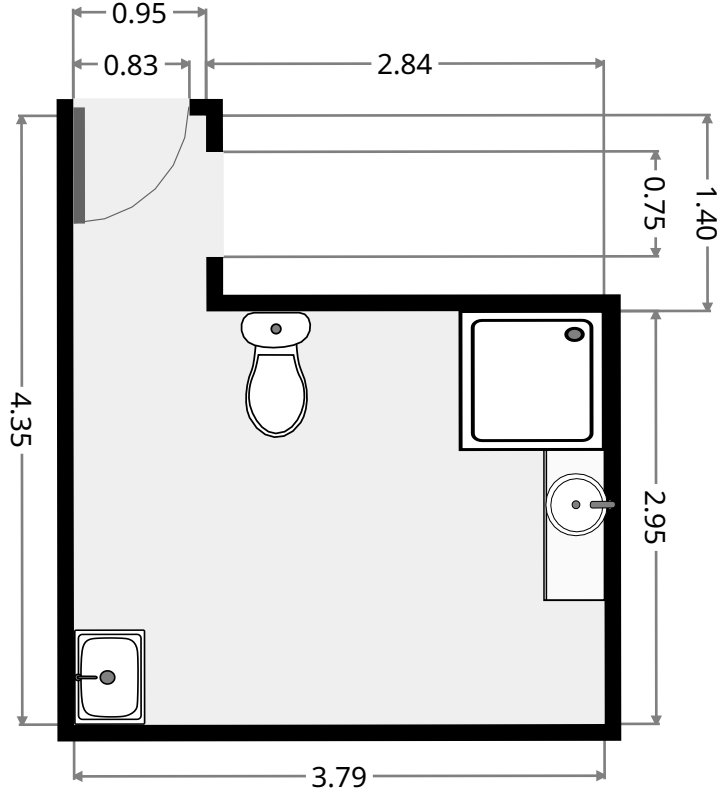
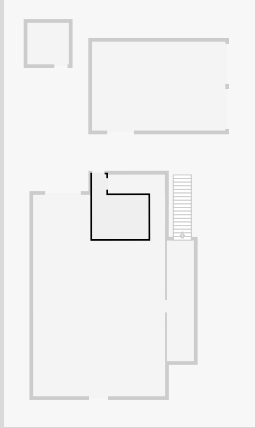

Stairway

Width: 1.27 m
 Length: 3.85 m
 Area: 4.89 m²
 Perimeter: 10.23 m

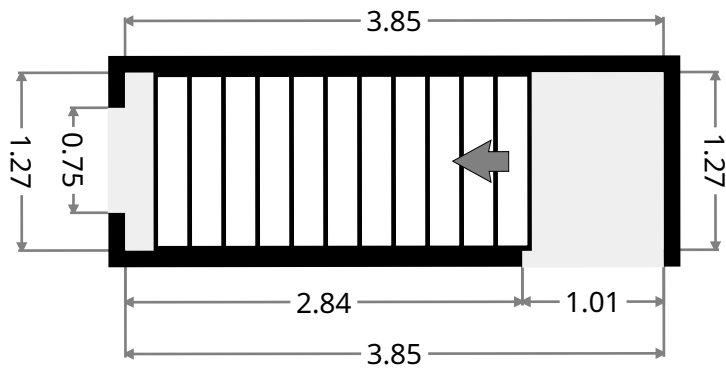
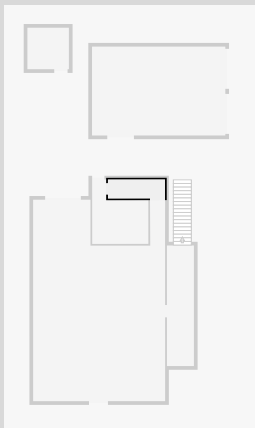

403 Stenhouse Street

Hall

Width: 1.02 m
Length: 2.95 m
Area: 2.98 m²
Perimeter: 7.92 m

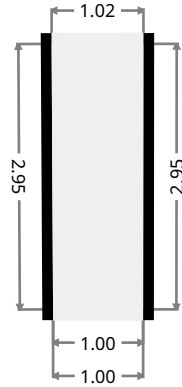
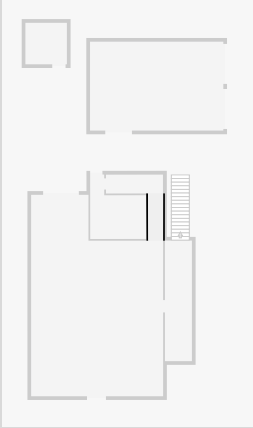

UnderCover Area

Width: 1.82 m
Length: 8.14 m
Area: 14.82 m²
Perimeter: 19.92 m

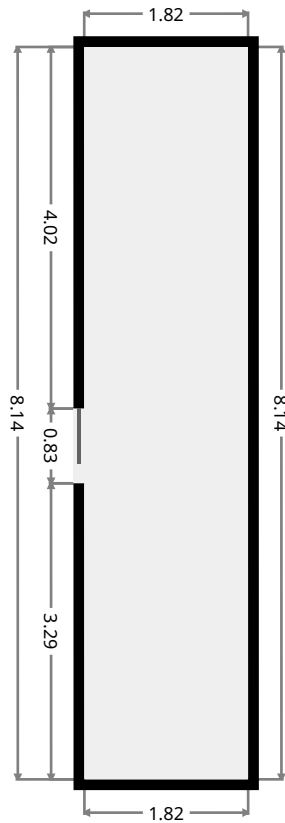
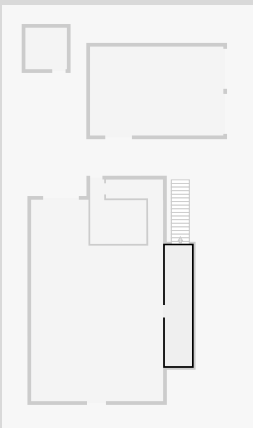

403 Stenhouse Street

Shed

Width: 6.00 m
Length: 9.00 m
Area: 54.00 m²
Perimeter: 30.00 m

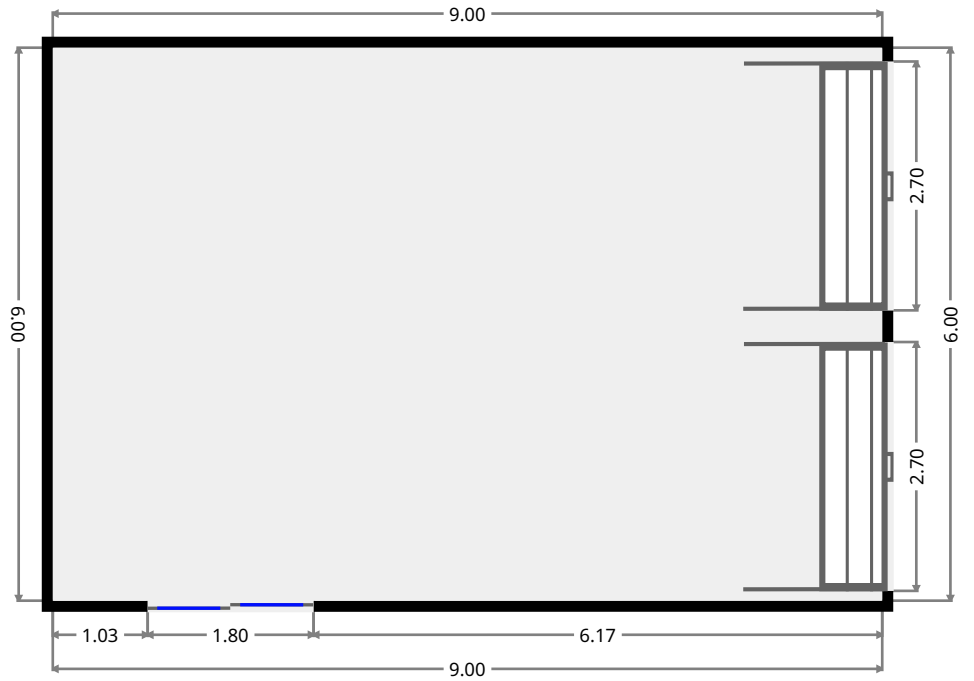
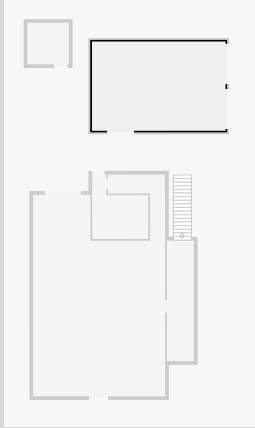

BBQ Area

Width: 2.80 m
Length: 2.80 m
Area: 7.84 m²
Perimeter: 11.20 m

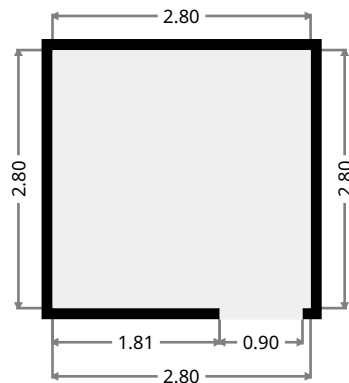
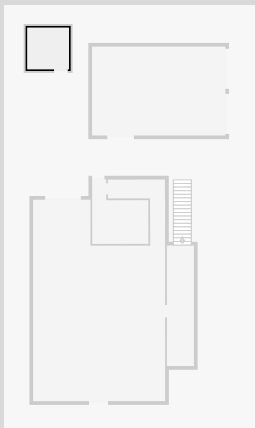

403 Stenhouse Street

1st Floor

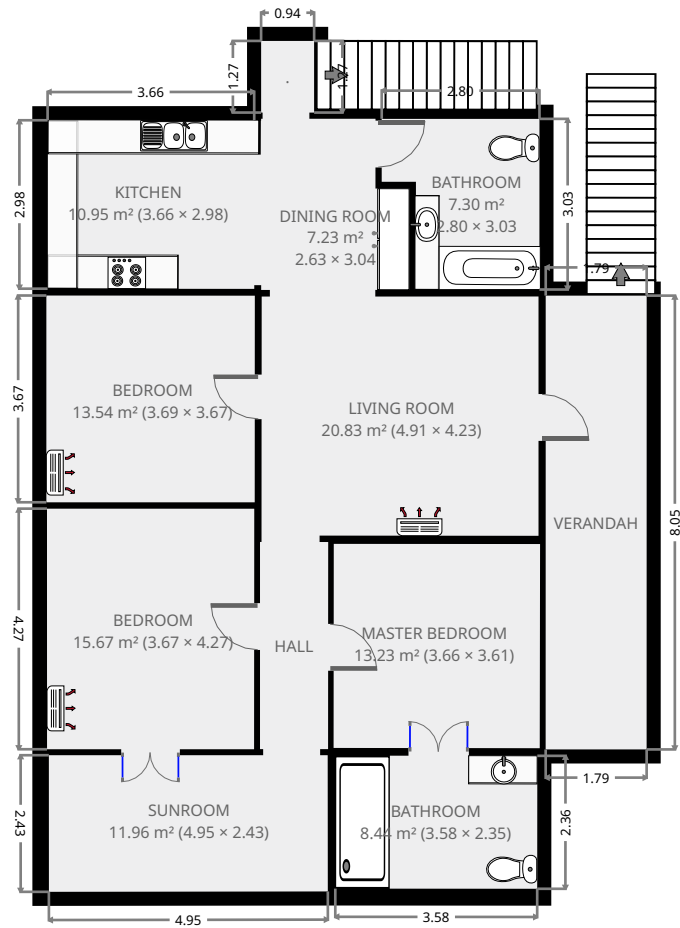

THIS FLOORPLAN IS PROVIDED WITHOUT WARRANTY OF ANY KIND. SENSOPIA DISCLAIMS ANY WARRANTY INCLUDING, WITHOUT LIMITATION, SATISFACTORY QUALITY OR ACCURACY OF DIMENSIONS.



403 Stenhouse Street

Living Room

Width: 4.23 m
 Length: 4.91 m
 Area: 20.83 m²
 Perimeter: 18.30 m

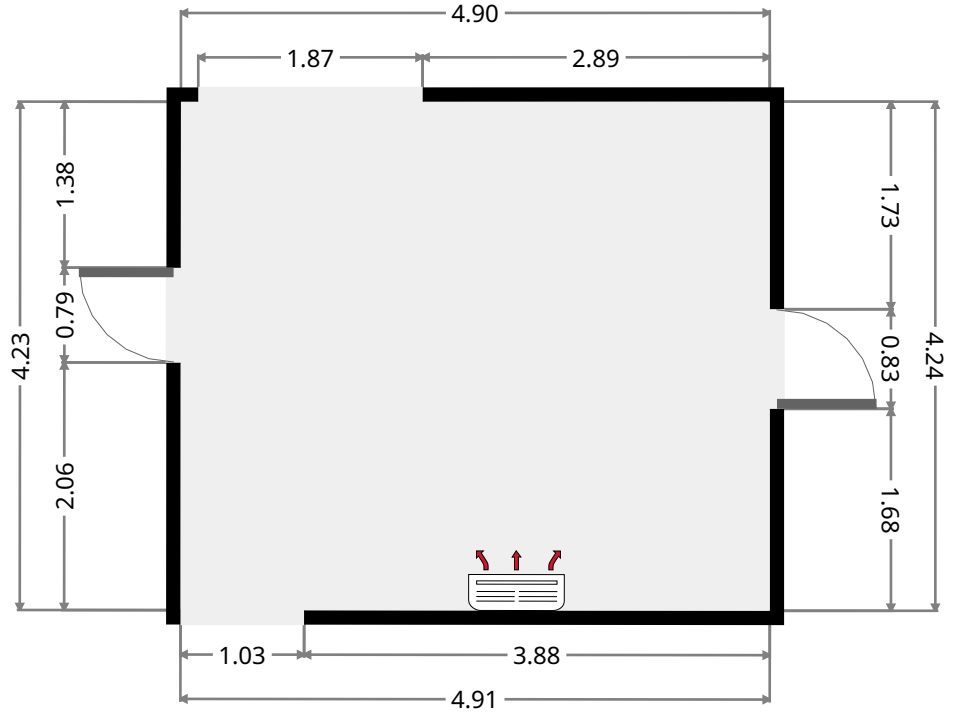
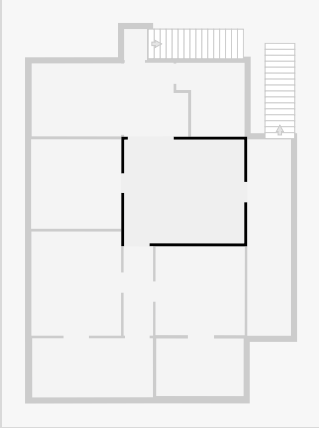

Dining Room

Width: 2.63 m
 Length: 3.04 m
 Area: 7.23 m²
 Perimeter: 11.32 m

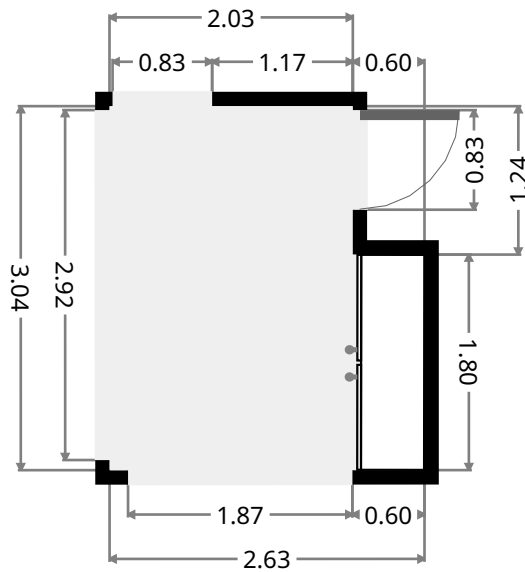
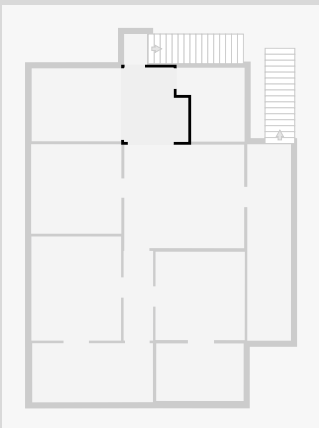

403 Stenhouse Street

Kitchen

Width: 2.98 m
 Length: 3.66 m
 Area: 10.95 m²
 Perimeter: 13.31 m

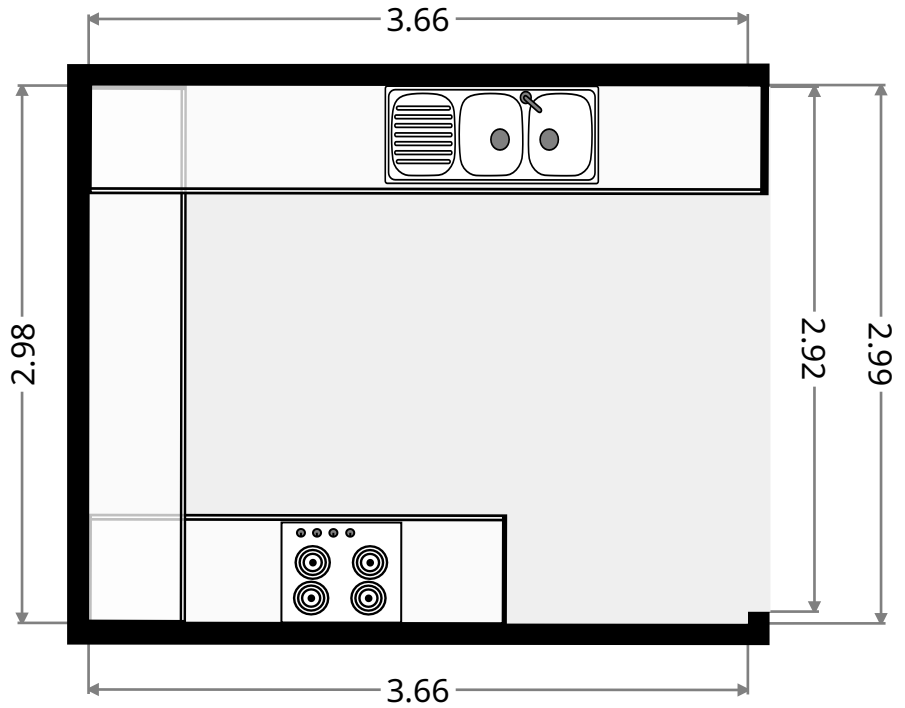
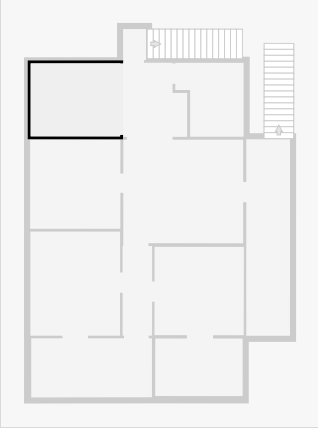

Bathroom

Width: 2.80 m
 Length: 3.03 m
 Area: 7.30 m²
 Perimeter: 11.65 m

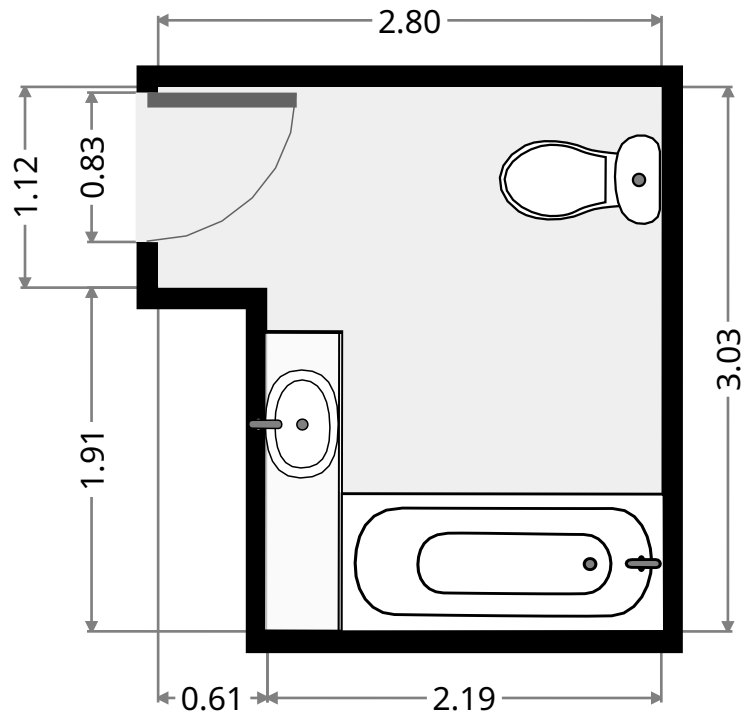
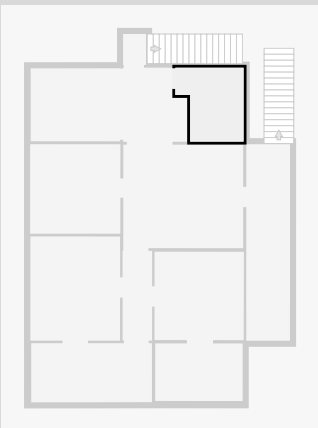

THIS FLOORPLAN IS PROVIDED WITHOUT WARRANTY OF ANY KIND. SENSOPIA DISCLAIMS ANY WARRANTY INCLUDING, WITHOUT LIMITATION, SATISFACTORY QUALITY OR ACCURACY OF DIMENSIONS.

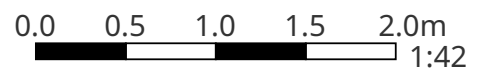

403 Stenhouse Street

Bedroom

Width: 3.67 m
 Length: 3.69 m
 Area: 13.54 m²
 Perimeter: 14.72 m

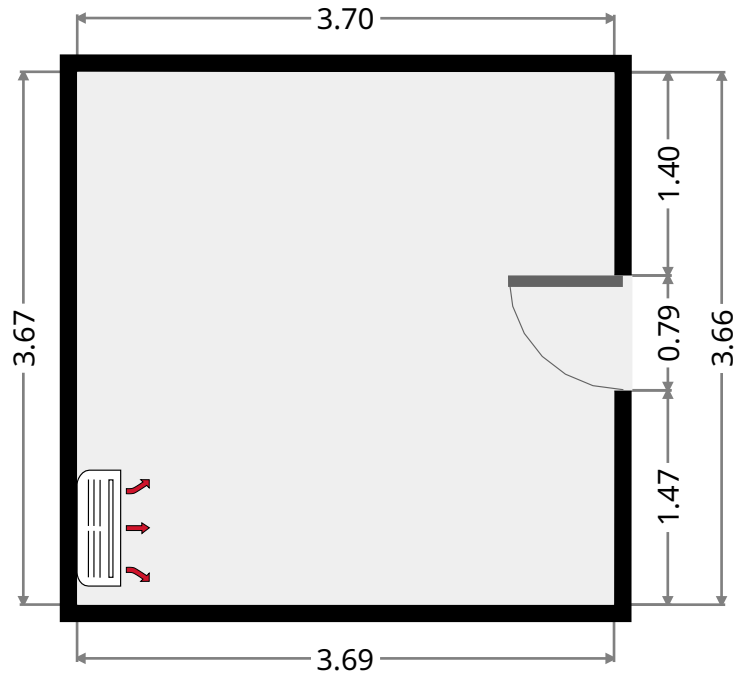
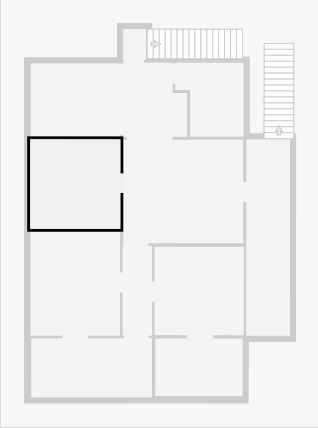

Hall

Width: 1.21 m
 Length: 3.68 m
 Area: 4.44 m²
 Perimeter: 9.76 m

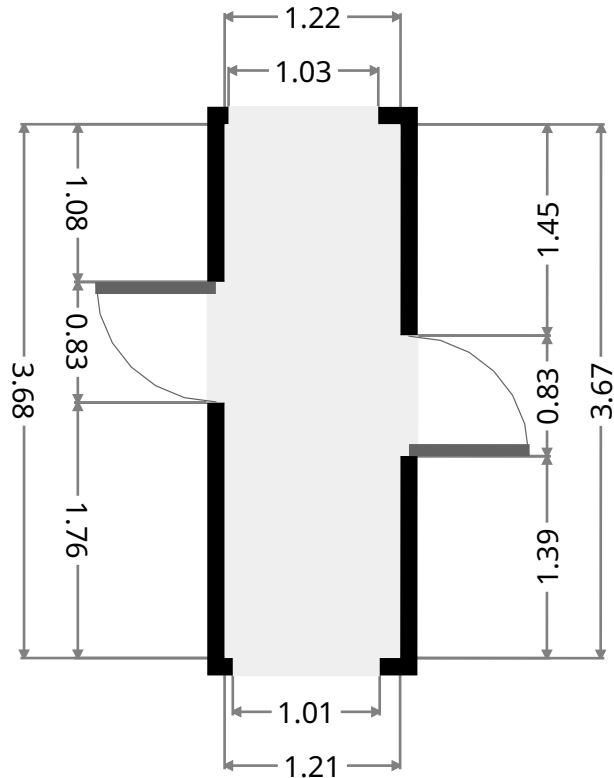
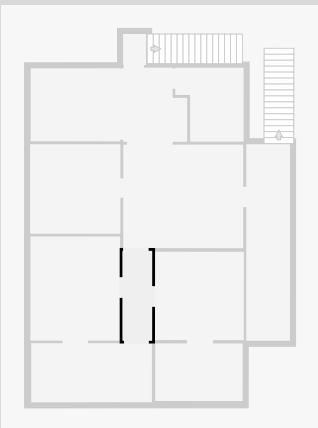

THIS FLOORPLAN IS PROVIDED WITHOUT WARRANTY OF ANY KIND. SENSOPIA DISCLAIMS ANY WARRANTY INCLUDING, WITHOUT LIMITATION, SATISFACTORY QUALITY OR ACCURACY OF DIMENSIONS.

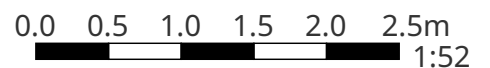

403 Stenhouse Street

Bedroom

Width: 3.67 m
 Length: 4.27 m
 Area: 15.67 m²
 Perimeter: 15.88 m

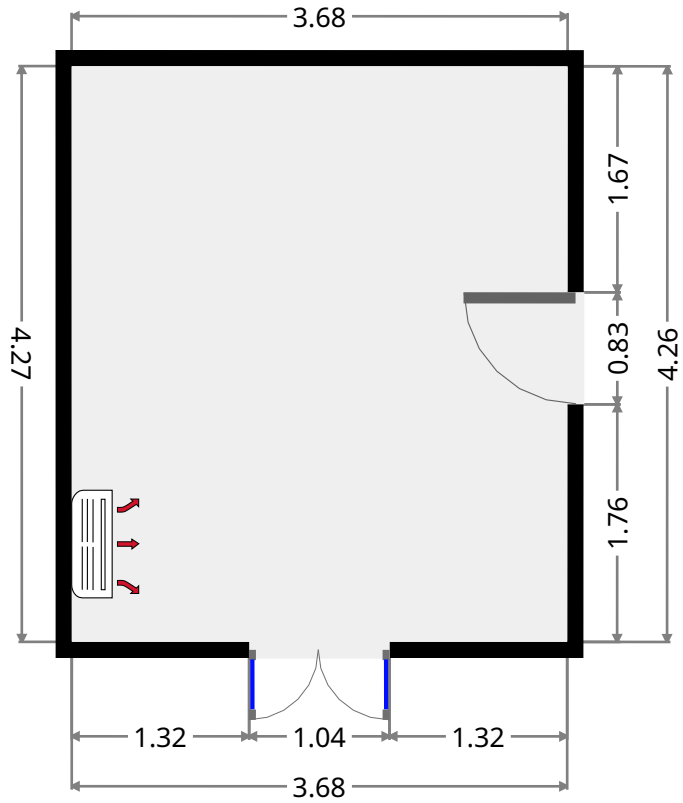
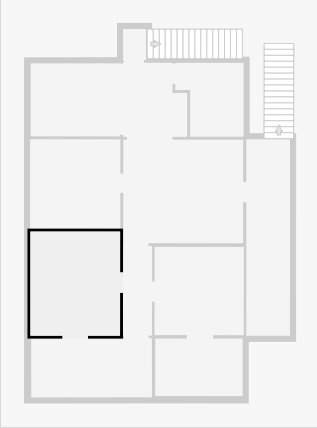

Master Bedroom

Width: 3.61 m
 Length: 3.66 m
 Area: 13.23 m²
 Perimeter: 14.55 m

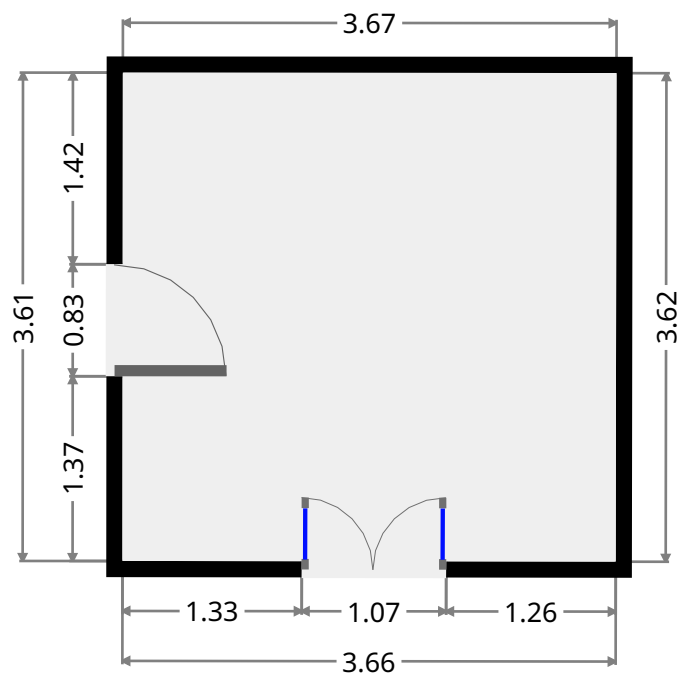
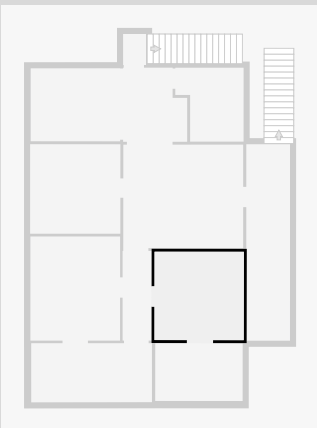

THIS FLOORPLAN IS PROVIDED WITHOUT WARRANTY OF ANY KIND. SENSOPIA DISCLAIMS ANY WARRANTY INCLUDING, WITHOUT LIMITATION, SATISFACTORY QUALITY OR ACCURACY OF DIMENSIONS.

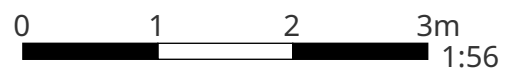

403 Stenhouse Street

Bathroom

Width: 2.35 m
 Length: 3.58 m
 Area: 8.44 m²
 Perimeter: 11.87 m

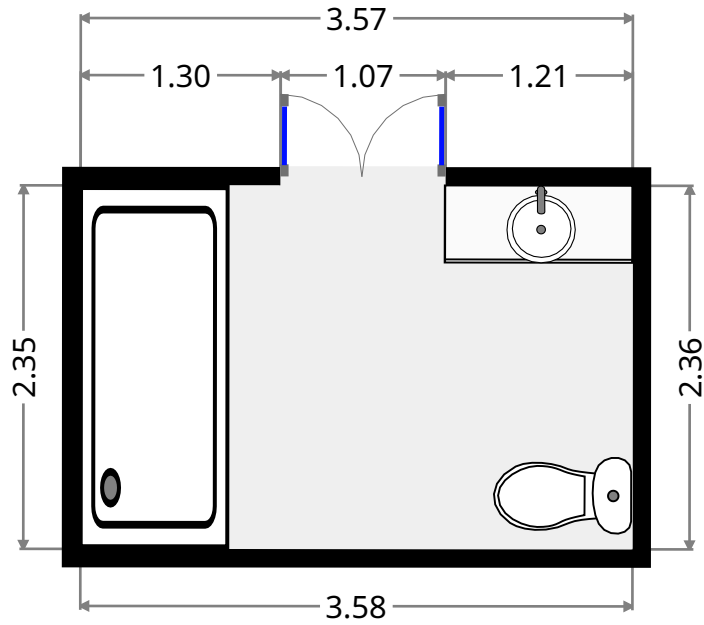
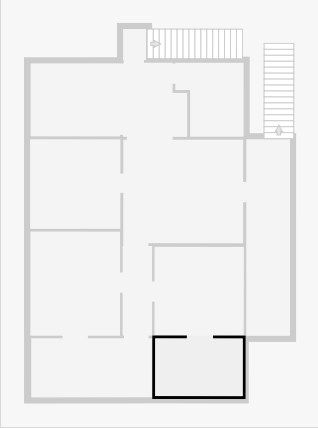

Sunroom

Width: 2.43 m
 Length: 4.95 m
 Area: 11.96 m²
 Perimeter: 14.73 m

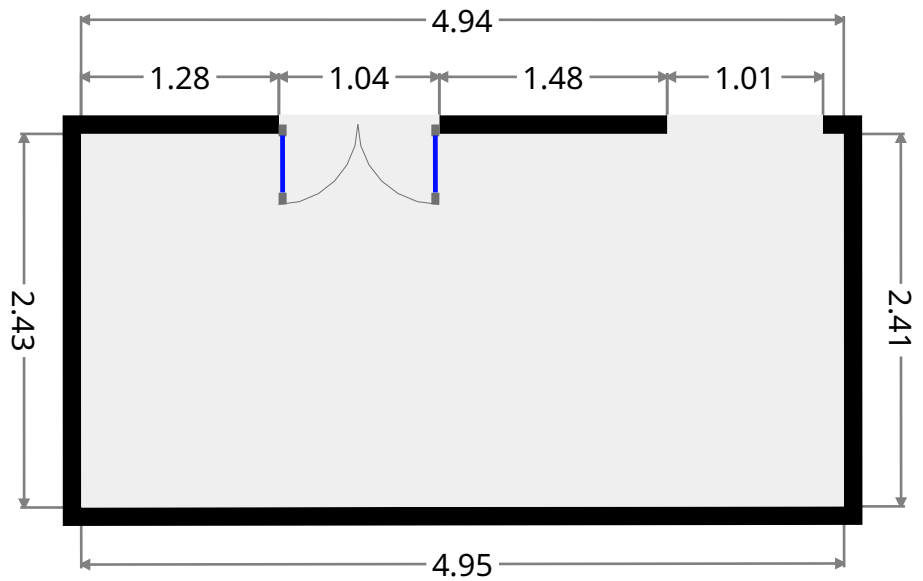
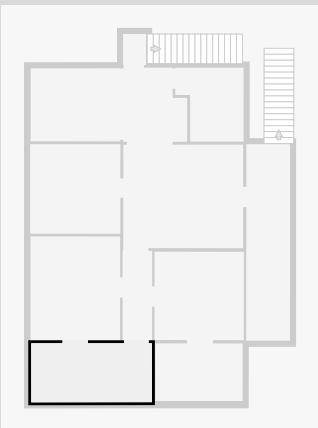

403 Stenhouse Street

Verandah

Width: 1.79 m
Length: 8.05 m
Area: 14.40 m²
Perimeter: 19.67 m

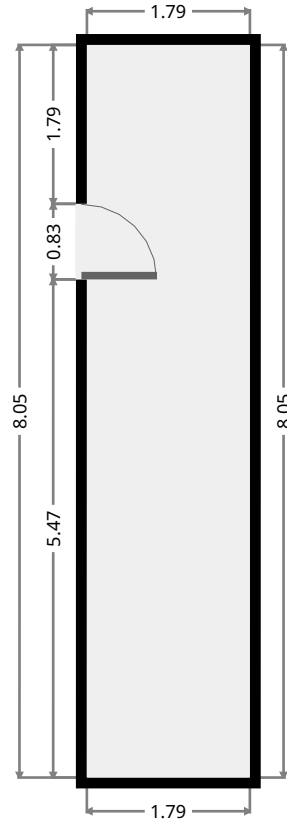
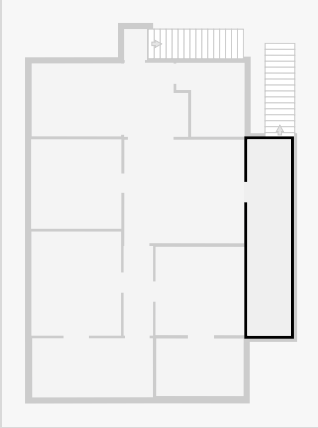

•
Width: 0.94 m
Length: 1.27 m
Area: 1.19 m²
Perimeter: 4.42 m

