

# 4 Tamarind Avenue

Created on  
2021-09-21

Floors  
1



## ▼ Ground Floor



▼ Living Room  
Ground Floor

WIDTH: 11.37 m • LENGTH: 7.55 m  
AREA: 63.15 m<sup>2</sup> • PERIMETER: 37.77 m

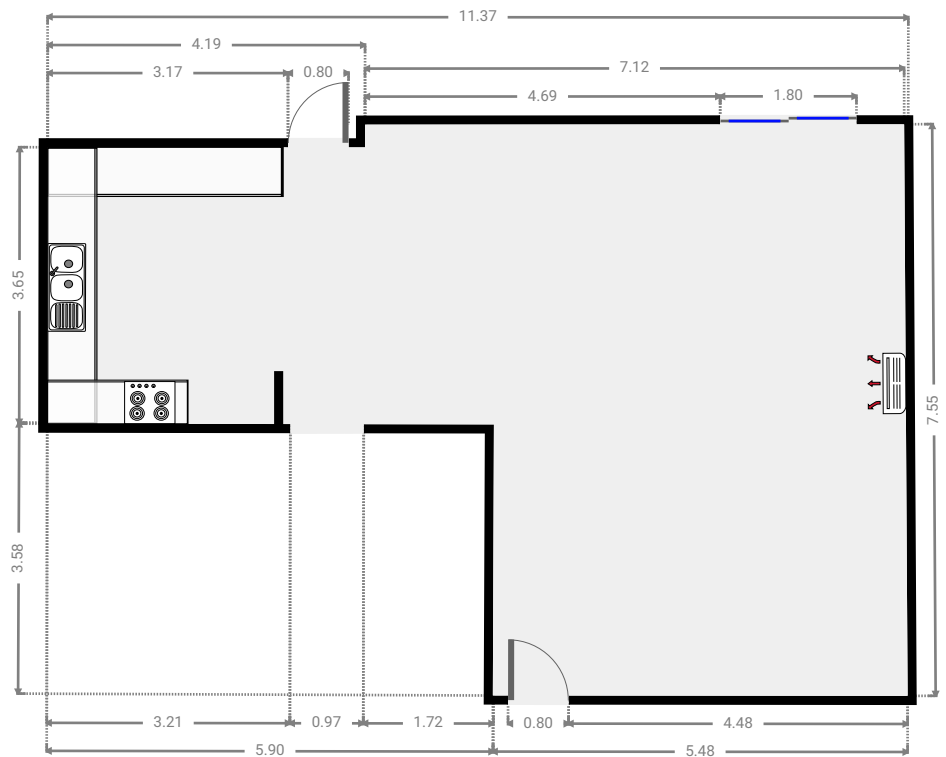
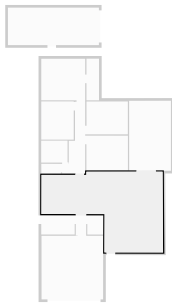

▼ Hall  
Ground Floor

WIDTH: 0.97 m • LENGTH: 1.93 m  
AREA: 1.87 m<sup>2</sup> • PERIMETER: 5.80 m

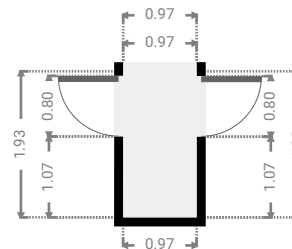
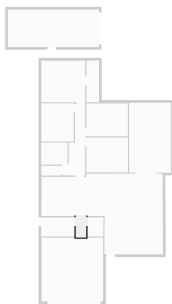

▼ Closet  
Ground Floor

WIDTH: 1.50 m • LENGTH: 1.78 m  
AREA: 2.67 m<sup>2</sup> • PERIMETER: 6.56 m

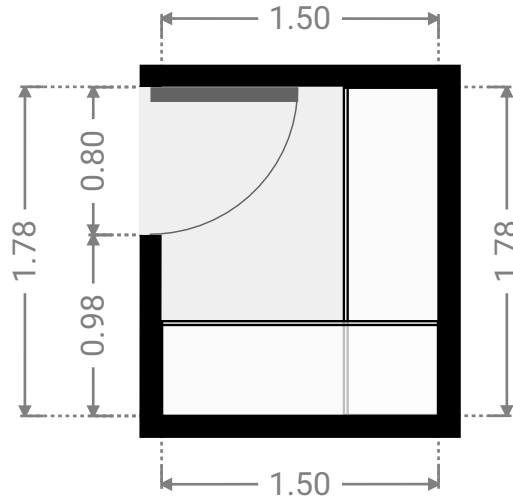
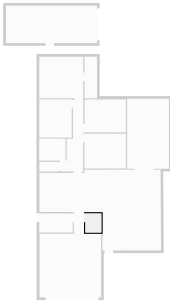

▼ Laundry Room  
Ground Floor

WIDTH: 3.12 m • LENGTH: 1.78 m  
AREA: 5.56 m<sup>2</sup> • PERIMETER: 9.80 m

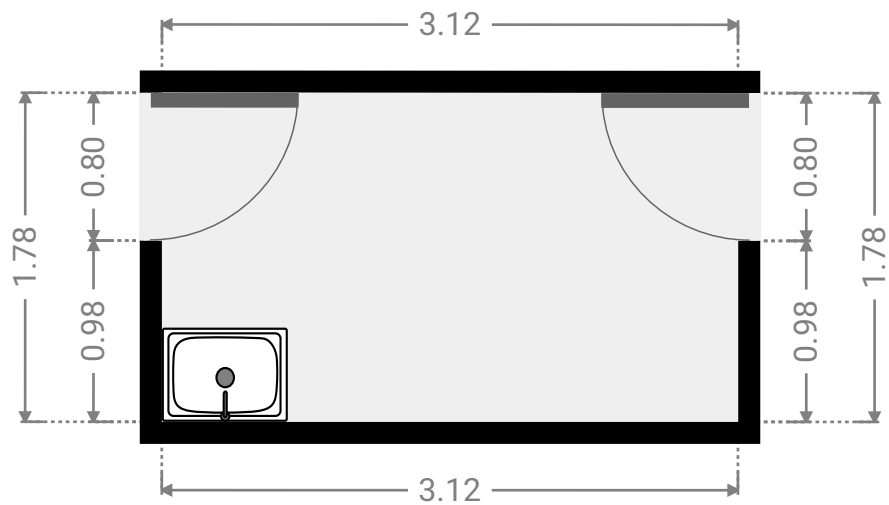
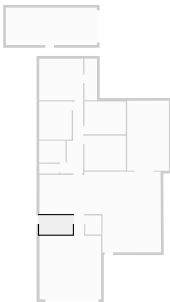

▼ **Garage**  
Ground Floor

WIDTH: 5.76 m • LENGTH: 5.94 m  
AREA: 34.18 m<sup>2</sup> • PERIMETER: 23.39 m

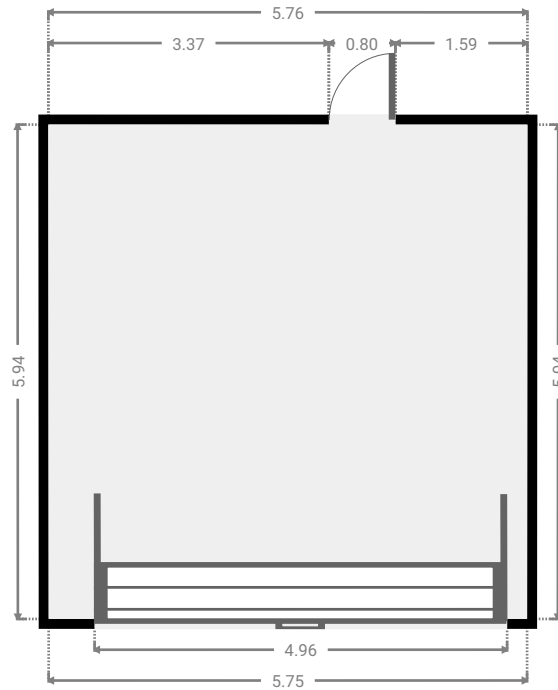
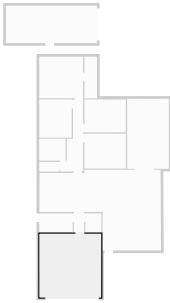

▼ **Hall**  
Ground Floor

WIDTH: 2.15 m • LENGTH: 6.70 m  
AREA: 8.71 m<sup>2</sup> • PERIMETER: 17.70 m

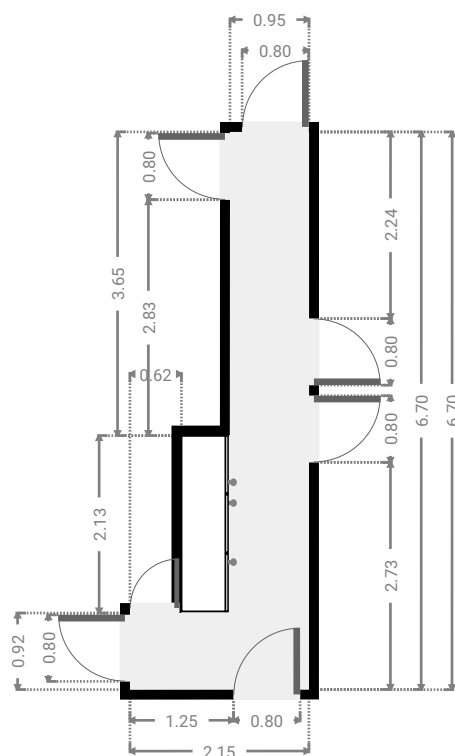

▼ **Toilet**  
Ground Floor

WIDTH: 1.83 m • LENGTH: 0.92 m  
AREA: 1.67 m<sup>2</sup> • PERIMETER: 5.48 m

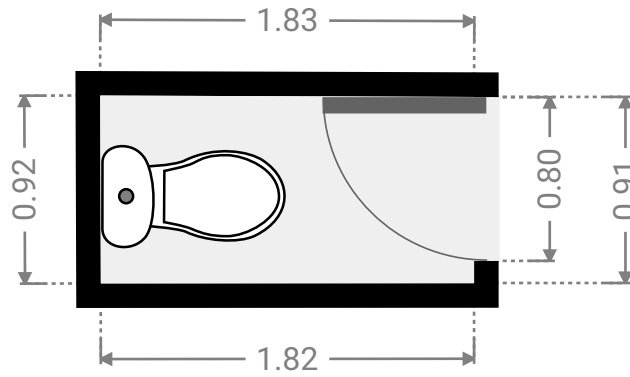
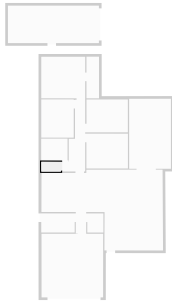

▼ **Bathroom**  
Ground Floor

WIDTH: 2.46 m • LENGTH: 2.05 m  
AREA: 5.04 m<sup>2</sup> • PERIMETER: 9.02 m

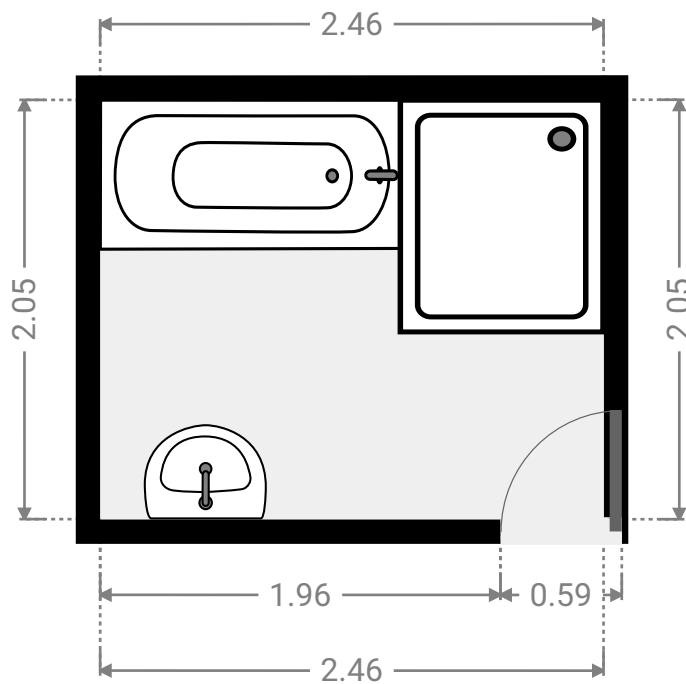
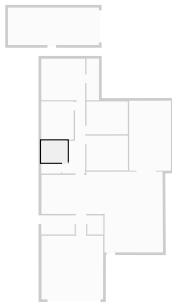

▼ **Bedroom**  
Ground Floor

WIDTH: 3.88 m • LENGTH: 3.25 m  
AREA: 12.61 m<sup>2</sup> • PERIMETER: 14.26 m

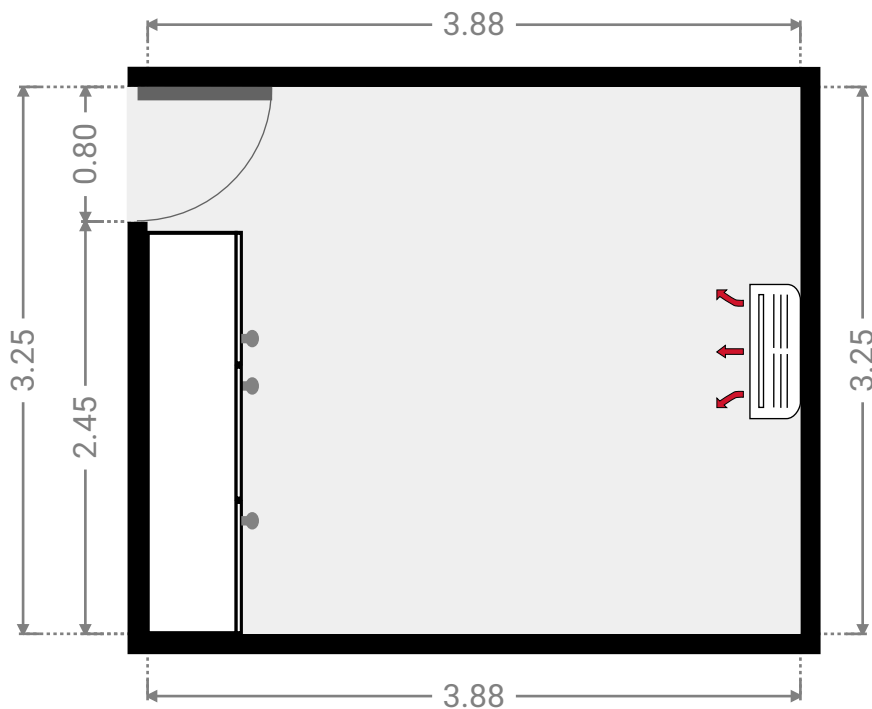
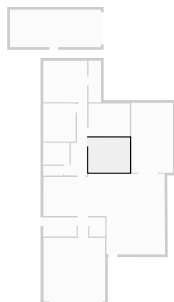

▼ **Bedroom**  
Ground Floor

WIDTH: 3.86 m • LENGTH: 3.07 m  
AREA: 11.85 m<sup>2</sup> • PERIMETER: 13.86 m

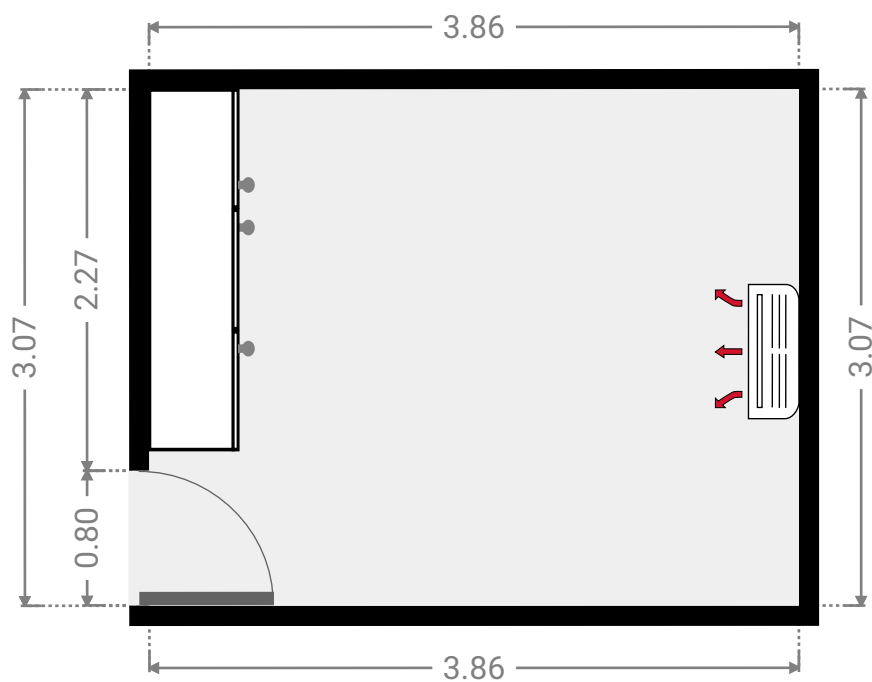
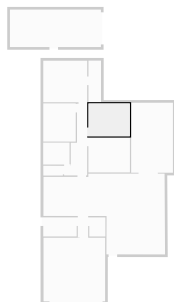

▼ **Bedroom**  
Ground Floor

WIDTH: 3.03 m • LENGTH: 3.57 m  
AREA: 10.81 m<sup>2</sup> • PERIMETER: 13.20 m

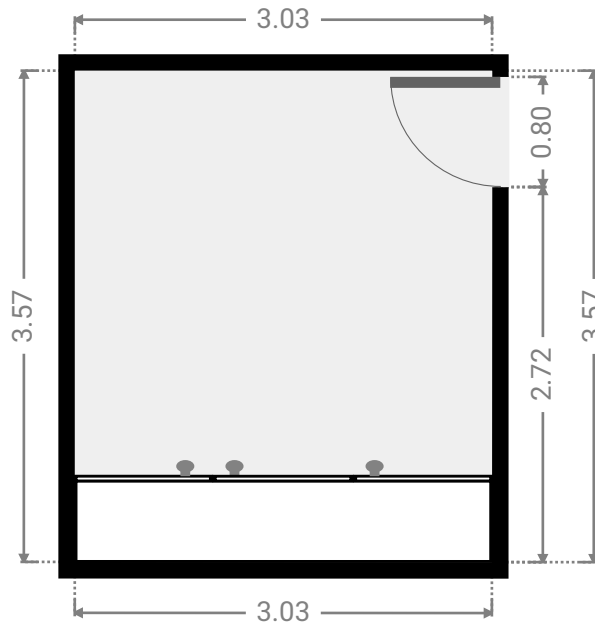
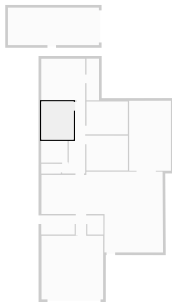

▼ **Master Bedroom**  
Ground Floor

WIDTH: 4.10 m • LENGTH: 3.88 m  
AREA: 15.91 m<sup>2</sup> • PERIMETER: 15.96 m

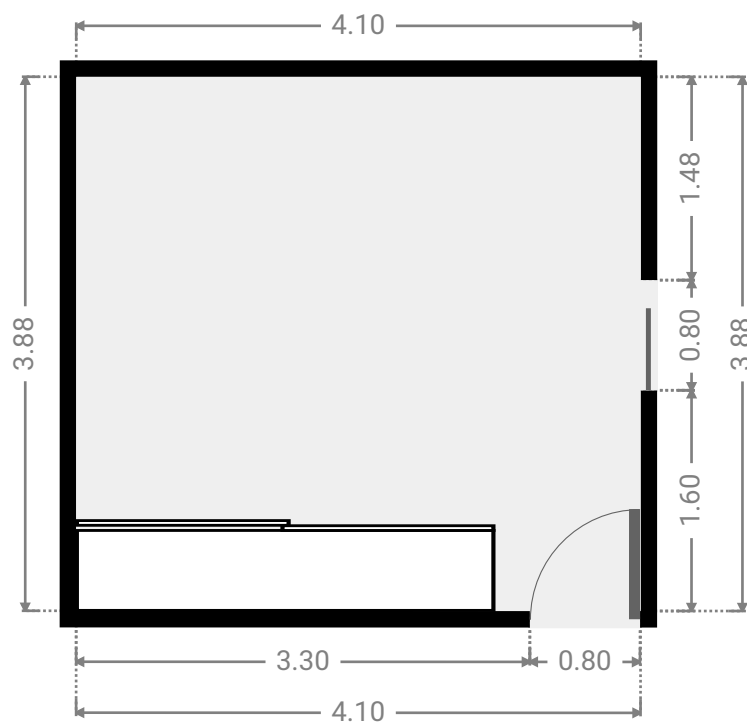
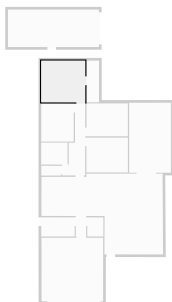



## ▼ Bathroom Ground Floor

WIDTH: 1.17 m • LENGTH: 3.89 m  
AREA: 4.55 m<sup>2</sup> • PERIMETER: 10.12 m

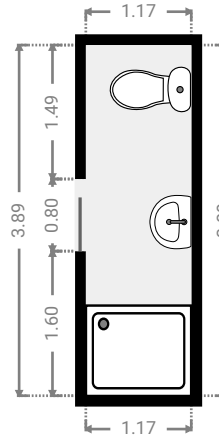
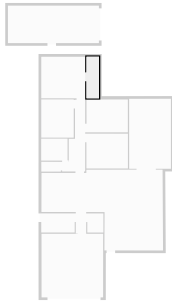

## ▼ Other Ground Floor

WIDTH: 3.91 m • LENGTH: 6.54 m  
AREA: 25.50 m<sup>2</sup> • PERIMETER: 20.88 m

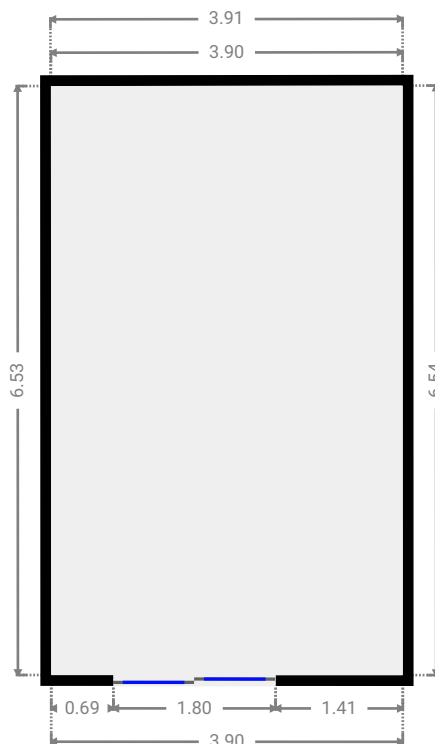
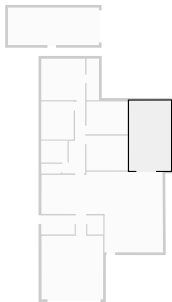

## ▼ Garage Ground Floor

WIDTH: 8.50 m • LENGTH: 3.50 m  
AREA: 29.75 m<sup>2</sup> • PERIMETER: 24.00 m

