

Ground Floor

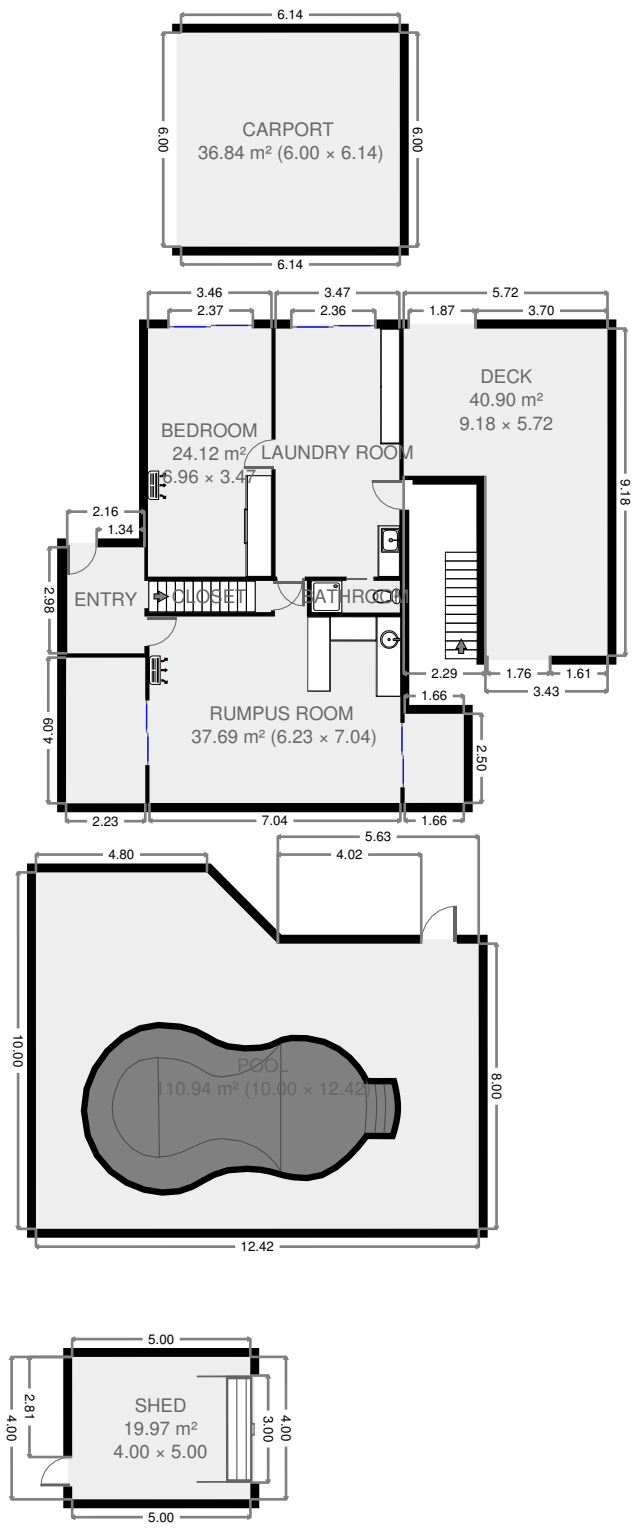

4 Schuffenhauer Street

THIS FLOORPLAN IS PROVIDED WITHOUT WARRANTY OF ANY KIND. SENSOPIA DISCLAIMS ANY WARRANTY INCLUDING, WITHOUT LIMITATION, SATISFACTORY QUALITY OR ACCURACY OF DIMENSIONS.

Entry

Width: 2.16 m
 Length: 2.97 m
 Area: 6.43 m²
 Perimeter: 10.27 m

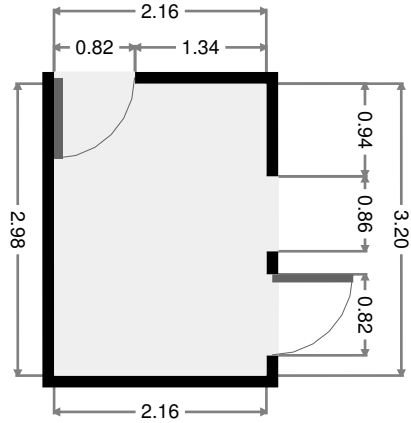

Rumpus Room

Width: 6.23 m
 Length: 7.04 m
 Area: 37.69 m²
 Perimeter: 26.54 m

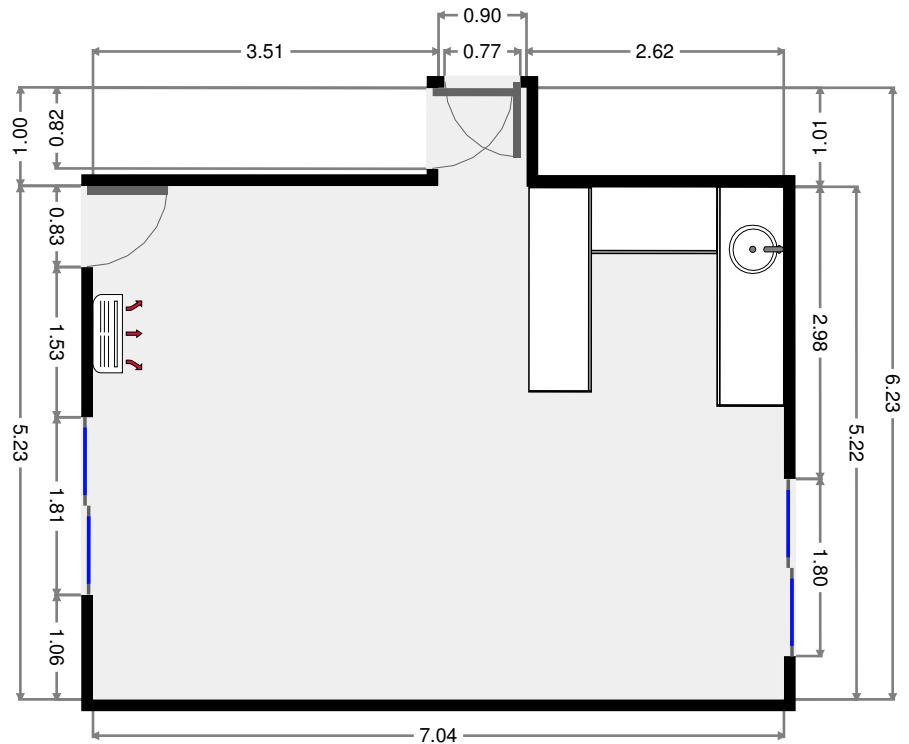

THIS FLOORPLAN IS PROVIDED WITHOUT WARRANTY OF ANY KIND. SENSOPIA DISCLAIMS ANY WARRANTY INCLUDING, WITHOUT LIMITATION, SATISFACTORY QUALITY OR ACCURACY OF DIMENSIONS.

Closet

Width: 0.87 m
 Length: 3.43 m
 Area: 3.00 m²
 Perimeter: 8.61 m

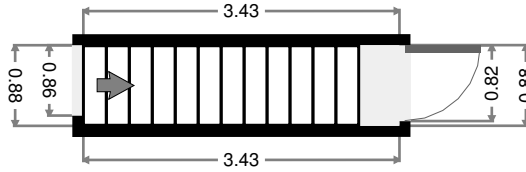

Laundry Room

Width: 3.47 m
 Length: 6.96 m
 Area: 24.15 m²
 Perimeter: 20.86 m

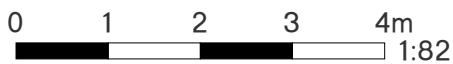
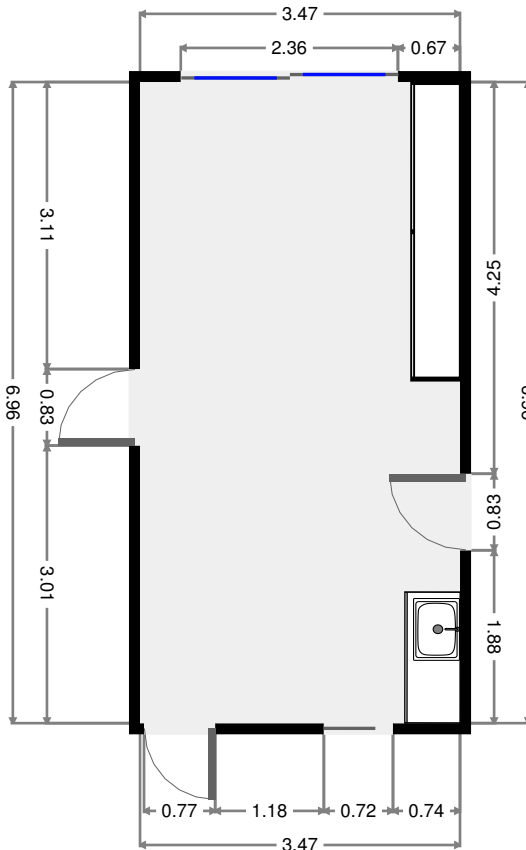

THIS FLOORPLAN IS PROVIDED WITHOUT WARRANTY OF ANY KIND. SENSOPIA DISCLAIMS ANY WARRANTY INCLUDING, WITHOUT LIMITATION, SATISFACTORY QUALITY OR ACCURACY OF DIMENSIONS.

Bathroom

Width: 0.89 m
Length: 2.49 m
Area: 2.21 m²
Perimeter: 6.75 m

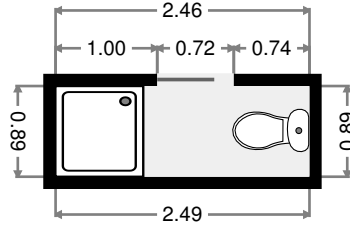
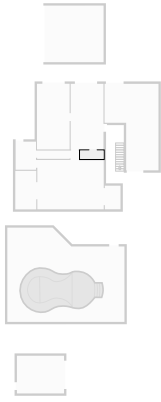

Bedroom

Width: 3.47 m
Length: 6.96 m
Area: 24.12 m²
Perimeter: 20.85 m

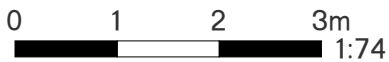
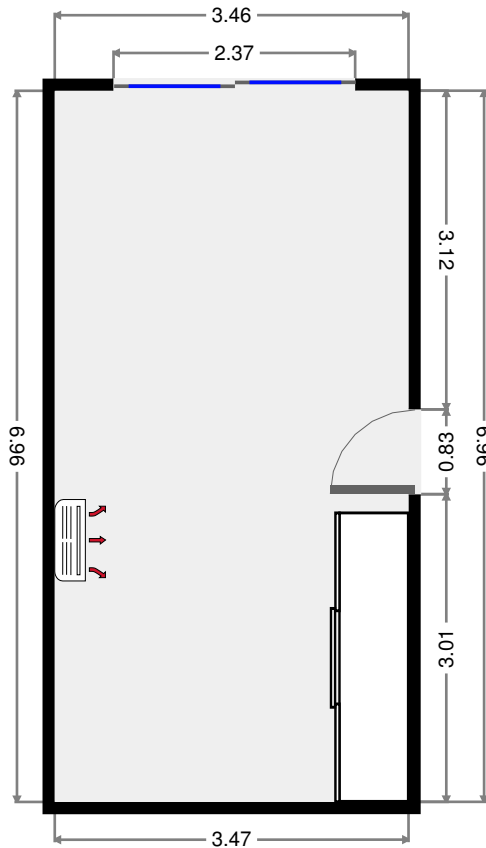

THIS FLOORPLAN IS PROVIDED WITHOUT WARRANTY OF ANY KIND. SENSOPIA DISCLAIMS ANY WARRANTY INCLUDING, WITHOUT LIMITATION, SATISFACTORY QUALITY OR ACCURACY OF DIMENSIONS.

Sitting Area

Width: 2.23 m
 Length: 4.09 m
 Area: 9.08 m²
 Perimeter: 12.62 m

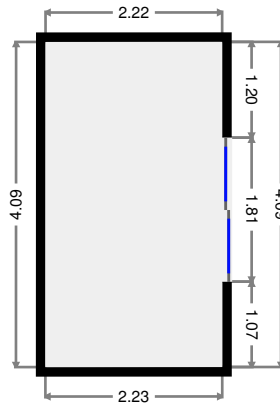

Deck

Width: 5.72 m
 Length: 9.18 m
 Area: 40.90 m²
 Perimeter: 29.79 m

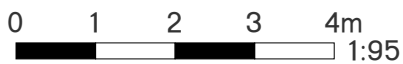
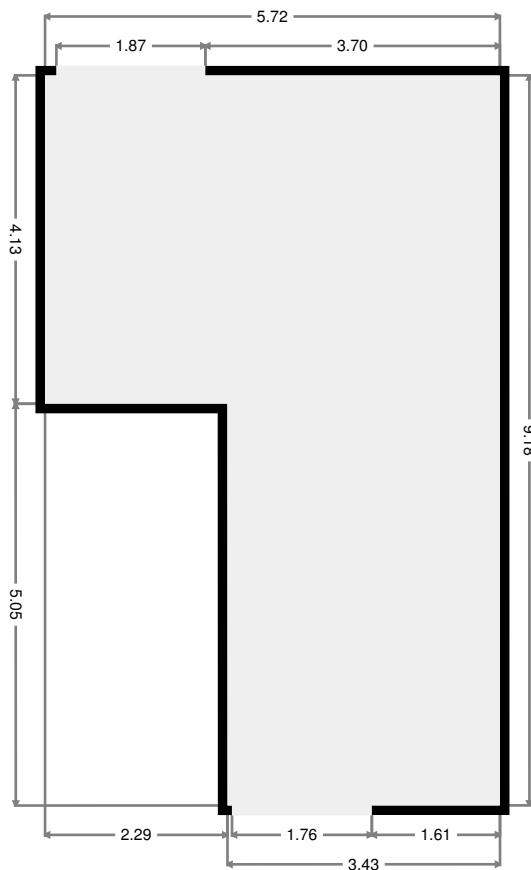

THIS FLOORPLAN IS PROVIDED WITHOUT WARRANTY OF ANY KIND. SENSOPIA DISCLAIMS ANY WARRANTY INCLUDING, WITHOUT LIMITATION, SATISFACTORY QUALITY OR ACCURACY OF DIMENSIONS.

Rear Entry

Width: 1.66 m
Length: 2.50 m
Area: 4.14 m²
Perimeter: 8.31 m

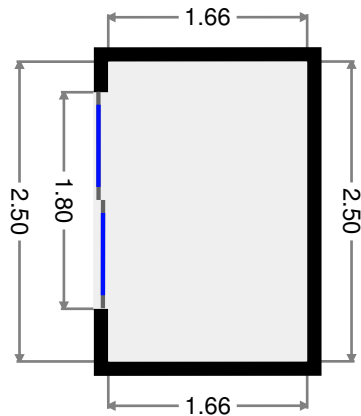

Carport

Width: 6.00 m
Length: 6.14 m
Area: 36.84 m²
Perimeter: 24.28 m

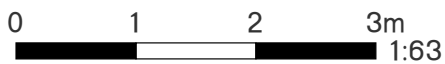
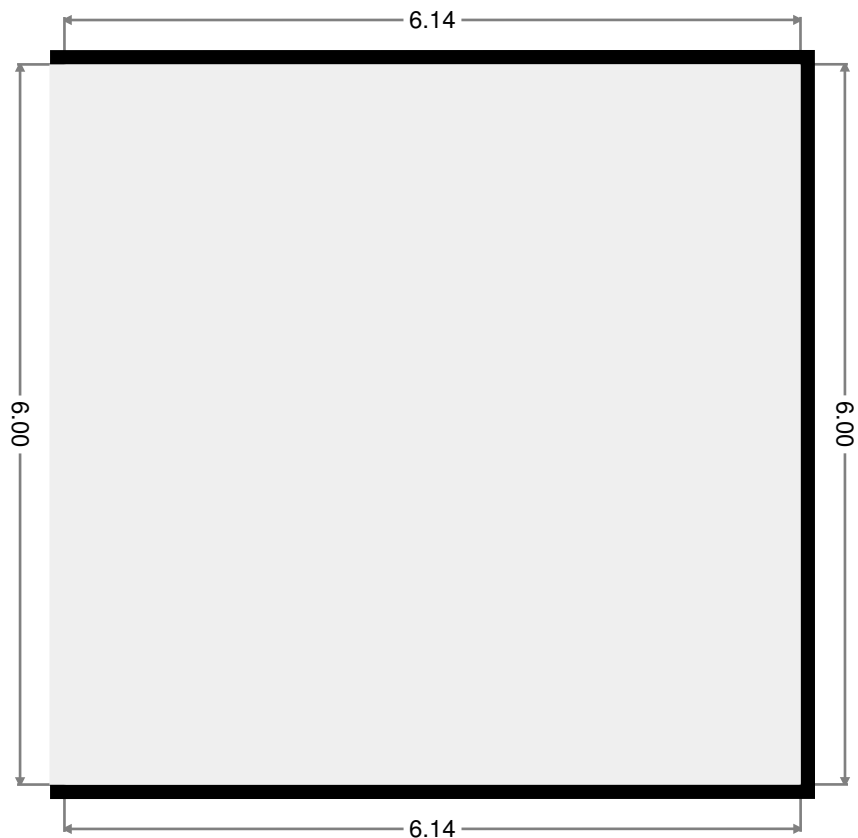

THIS FLOORPLAN IS PROVIDED WITHOUT WARRANTY OF ANY KIND. SENSOPIA DISCLAIMS ANY WARRANTY INCLUDING, WITHOUT LIMITATION, SATISFACTORY QUALITY OR ACCURACY OF DIMENSIONS.

Pool

Width: 10.00 m
Length: 12.42 m
Area: 110.94 m²
Perimeter: 43.67 m
Ceiling Height: 2.17 m

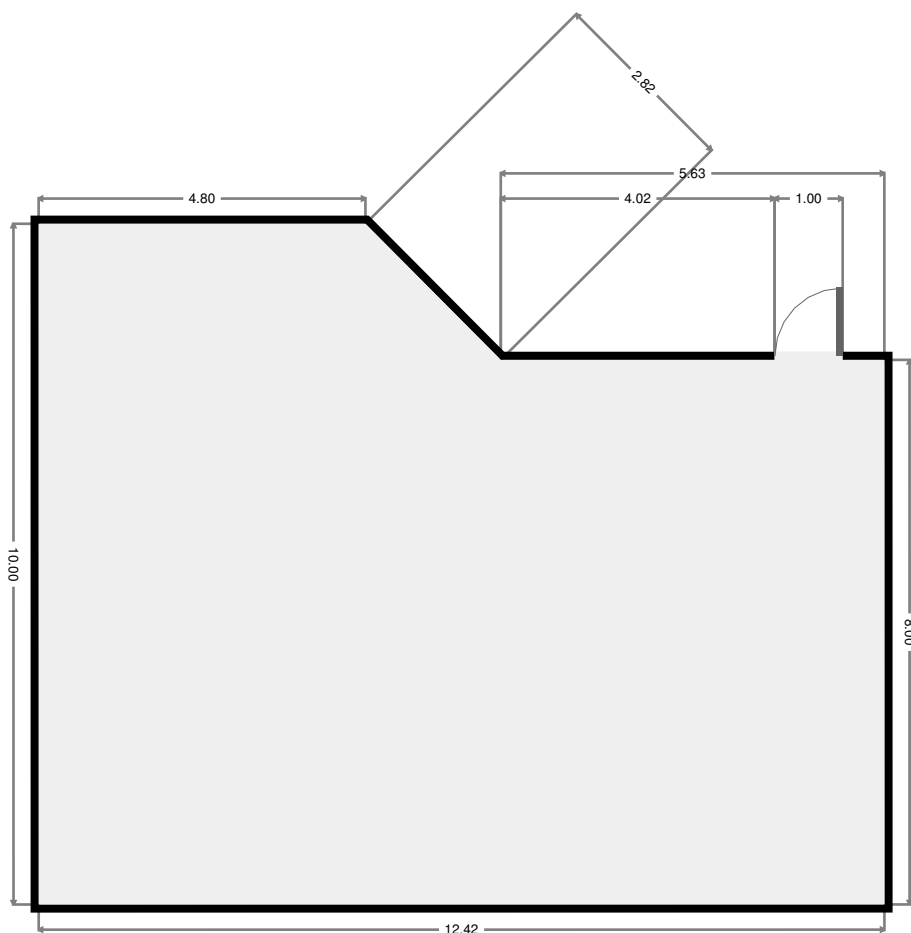
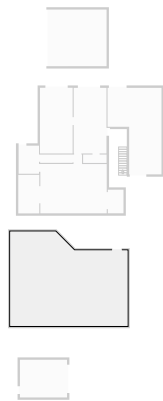

THIS FLOORPLAN IS PROVIDED WITHOUT WARRANTY OF ANY KIND. SENSOPIA DISCLAIMS ANY WARRANTY INCLUDING, WITHOUT LIMITATION, SATISFACTORY QUALITY OR ACCURACY OF DIMENSIONS.



4 Schuffenhauer Street

2017-04-03

Shed

Width: 4.00 m
Length: 5.00 m
Area: 19.97 m²
Perimeter: 17.99 m

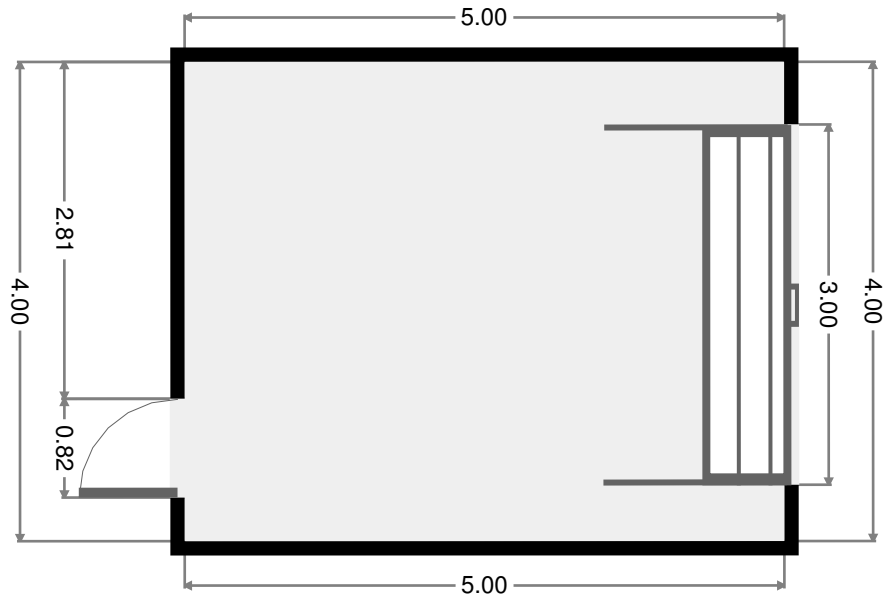

THIS FLOORPLAN IS PROVIDED WITHOUT WARRANTY OF ANY KIND. SENSOPIA DISCLAIMS ANY WARRANTY INCLUDING, WITHOUT LIMITATION, SATISFACTORY QUALITY OR ACCURACY OF DIMENSIONS.

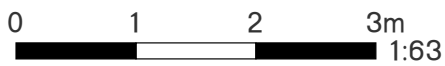

4 Schuffenhauer Street

2017-04-03

1st Floor



4 Schuffenhauer Street

THIS FLOORPLAN IS PROVIDED WITHOUT WARRANTY OF ANY KIND. SENSOPIA DISCLAIMS ANY WARRANTY INCLUDING, WITHOUT LIMITATION, SATISFACTORY QUALITY OR ACCURACY OF DIMENSIONS.

Hall

Width: 1.99 m
 Length: 4.23 m
 Area: 4.65 m²
 Perimeter: 12.45 m

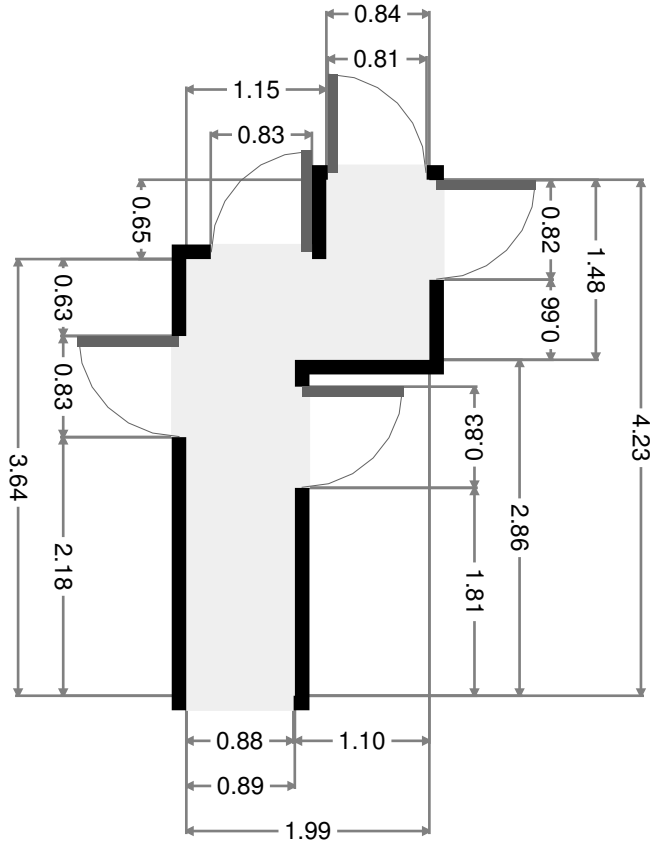
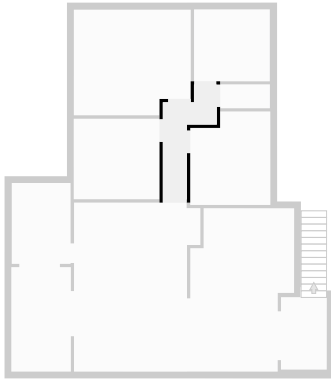

Bedroom

Width: 2.97 m
 Length: 3.18 m
 Area: 9.42 m²
 Perimeter: 12.29 m

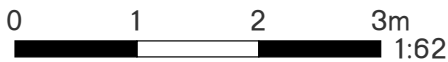
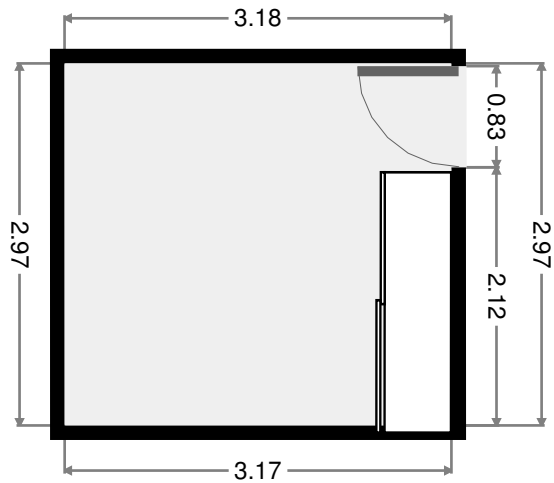
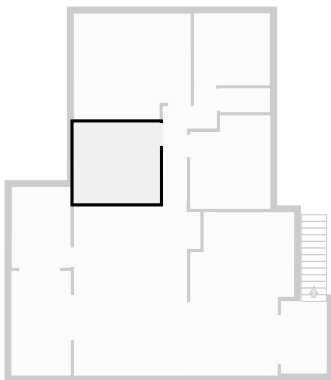

THIS FLOORPLAN IS PROVIDED WITHOUT WARRANTY OF ANY KIND. SENSOPIA DISCLAIMS ANY WARRANTY INCLUDING, WITHOUT LIMITATION, SATISFACTORY QUALITY OR ACCURACY OF DIMENSIONS.

Bedroom

Width: 2.96 m
 Length: 3.45 m
 Area: 9.52 m²
 Perimeter: 12.81 m

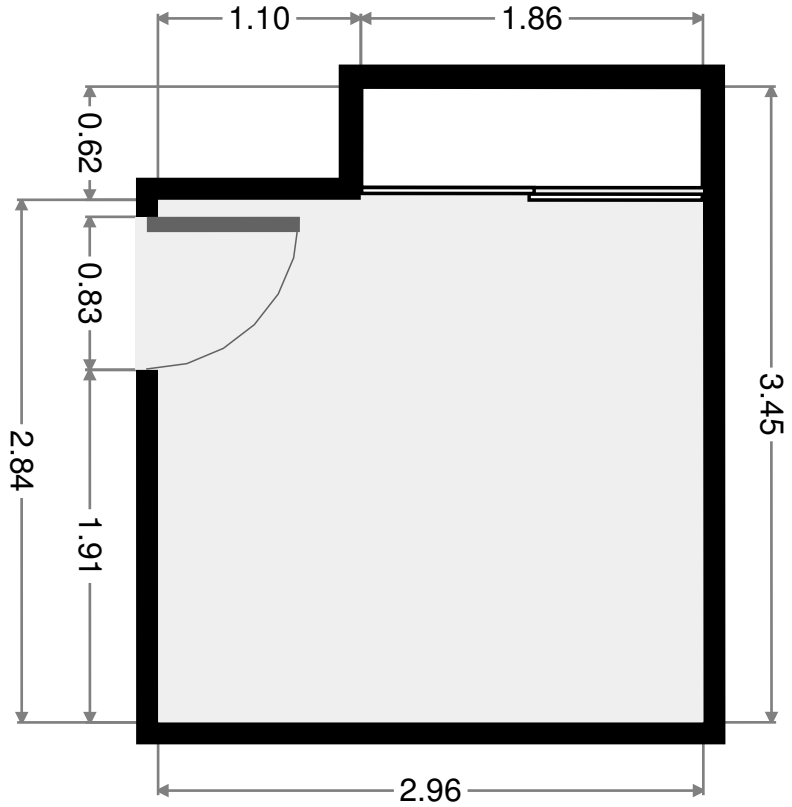
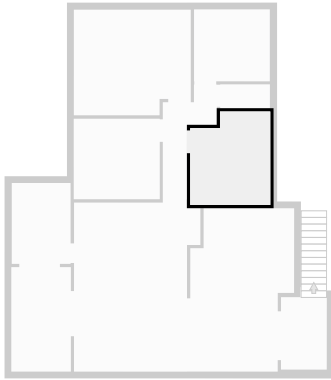

Toilet

Width: 0.88 m
 Length: 1.83 m
 Area: 1.62 m²
 Perimeter: 5.43 m

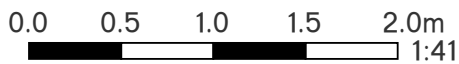
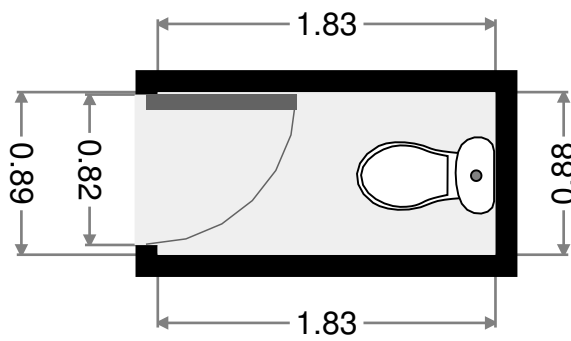
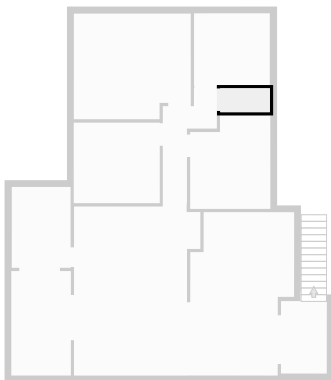

THIS FLOORPLAN IS PROVIDED WITHOUT WARRANTY OF ANY KIND. SENSOPIA DISCLAIMS ANY WARRANTY INCLUDING, WITHOUT LIMITATION, SATISFACTORY QUALITY OR ACCURACY OF DIMENSIONS.

Bathroom

Width: 2.65 m
 Length: 2.80 m
 Area: 7.42 m²
 Perimeter: 10.90 m

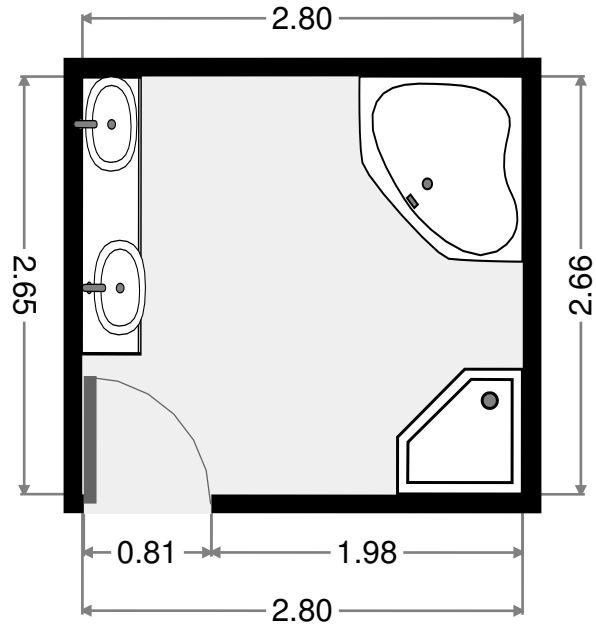
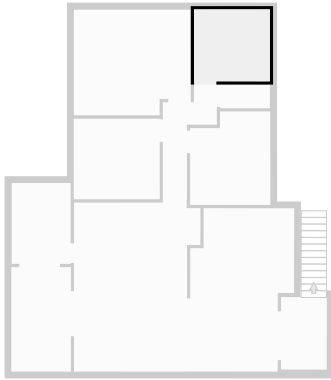

Master Bedroom

Width: 3.89 m
 Length: 4.31 m
 Area: 16.10 m²
 Perimeter: 16.41 m

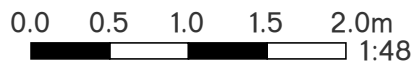
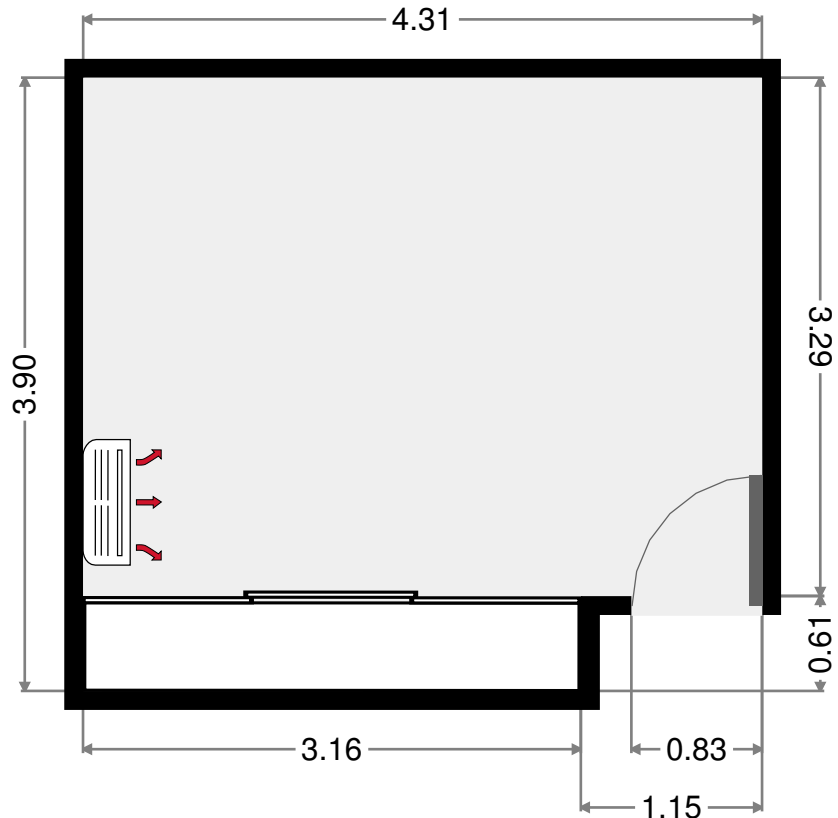
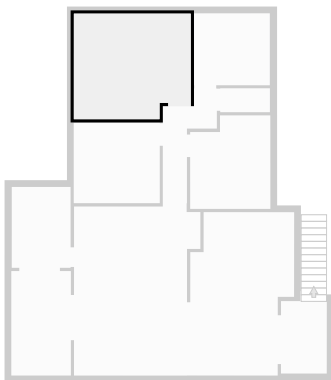

THIS FLOORPLAN IS PROVIDED WITHOUT WARRANTY OF ANY KIND. SENSOPIA DISCLAIMS ANY WARRANTY INCLUDING, WITHOUT LIMITATION, SATISFACTORY QUALITY OR ACCURACY OF DIMENSIONS.

Living Room

Width: 4.66 m
 Length: 6.23 m
 Area: 26.64 m²
 Perimeter: 21.79 m

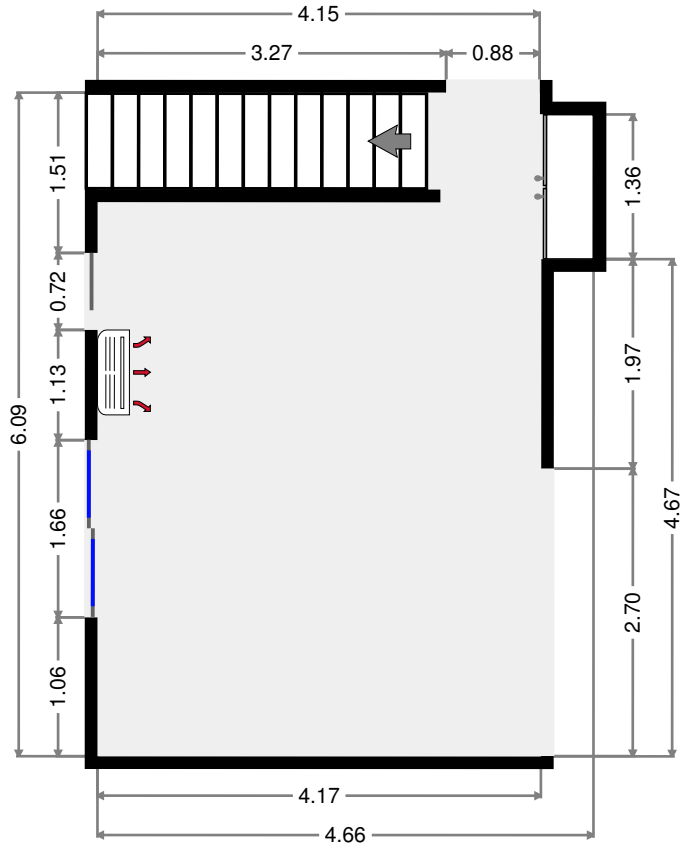
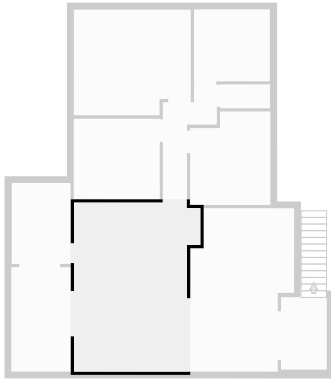

Kitchen

Width: 3.83 m
 Length: 6.03 m
 Area: 20.61 m²
 Perimeter: 19.71 m

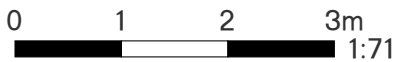
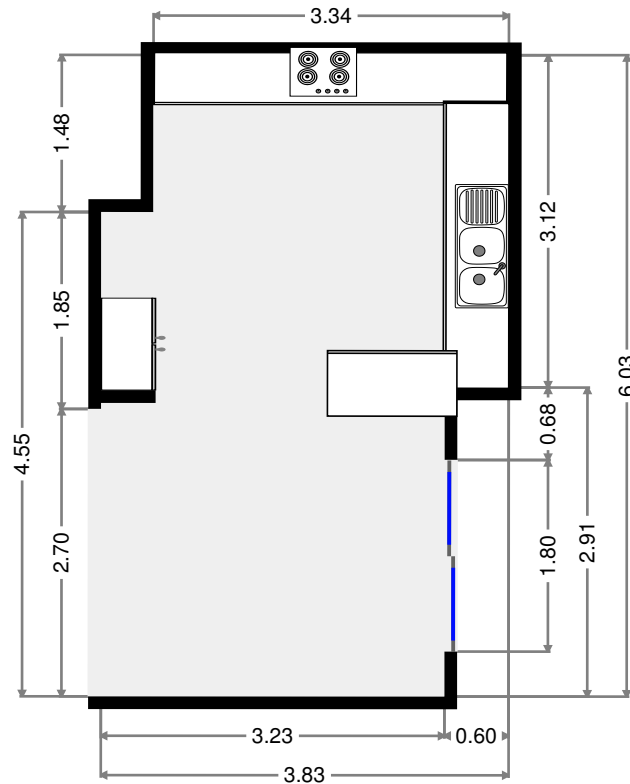
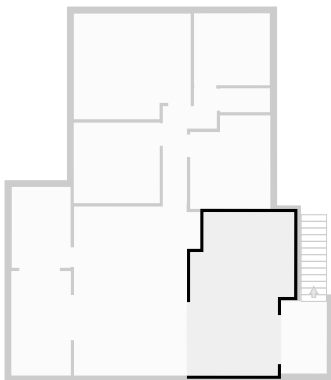

THIS FLOORPLAN IS PROVIDED WITHOUT WARRANTY OF ANY KIND. SENSOPIA DISCLAIMS ANY WARRANTY INCLUDING, WITHOUT LIMITATION, SATISFACTORY QUALITY OR ACCURACY OF DIMENSIONS.

Verandah

Width: 1.69 m
 Length: 2.67 m
 Area: 4.51 m²
 Perimeter: 8.72 m

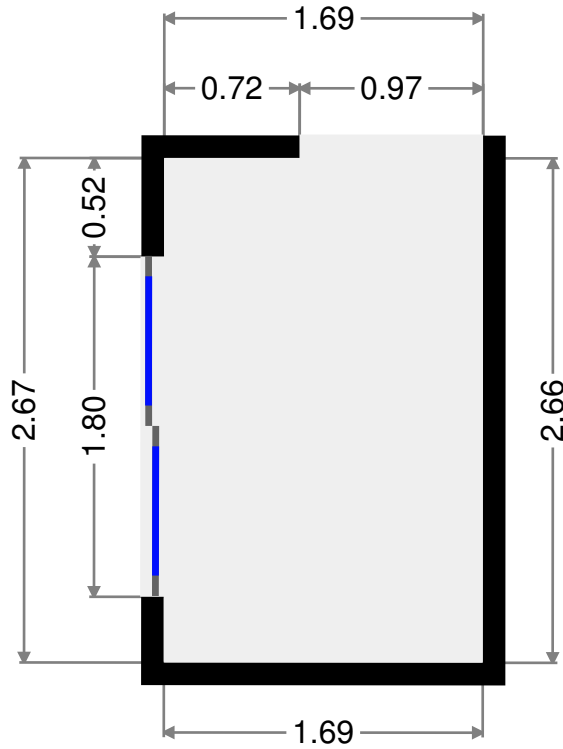
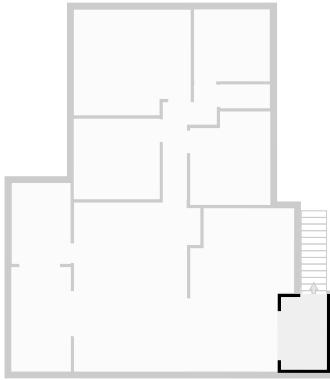

Office

Width: 2.17 m
 Length: 2.98 m
 Area: 6.47 m²
 Perimeter: 10.30 m

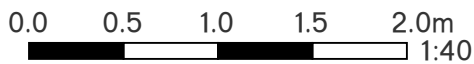
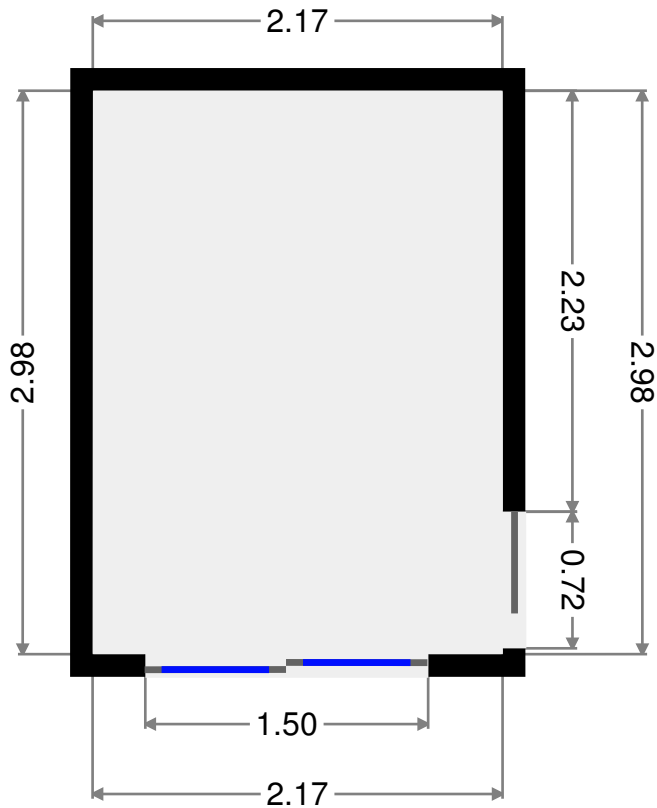
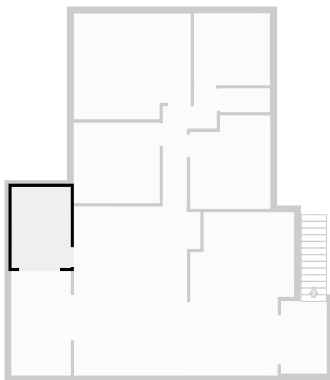

THIS FLOORPLAN IS PROVIDED WITHOUT WARRANTY OF ANY KIND. SENSOPIA DISCLAIMS ANY WARRANTY INCLUDING, WITHOUT LIMITATION, SATISFACTORY QUALITY OR ACCURACY OF DIMENSIONS.

Front Verandah

Width: 2.20 m
Length: 3.85 m
Area: 8.46 m²
Perimeter: 12.10 m

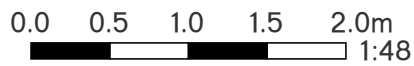
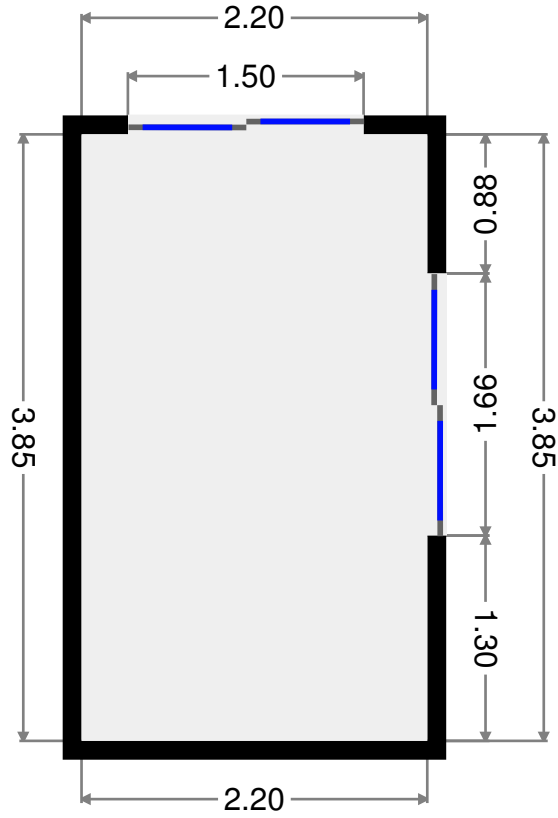
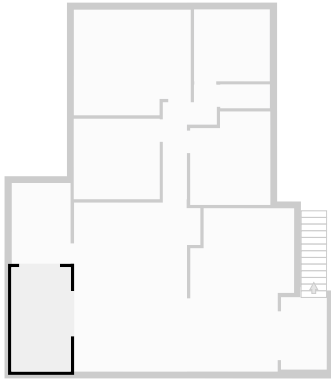

THIS FLOORPLAN IS PROVIDED WITHOUT WARRANTY OF ANY KIND. SENSOPIA DISCLAIMS ANY WARRANTY INCLUDING, WITHOUT LIMITATION, SATISFACTORY QUALITY OR ACCURACY OF DIMENSIONS.