

# 4 Hardacre Street

Created on  
2021-09-14

Floors  
1

## ▼ Ground Floor

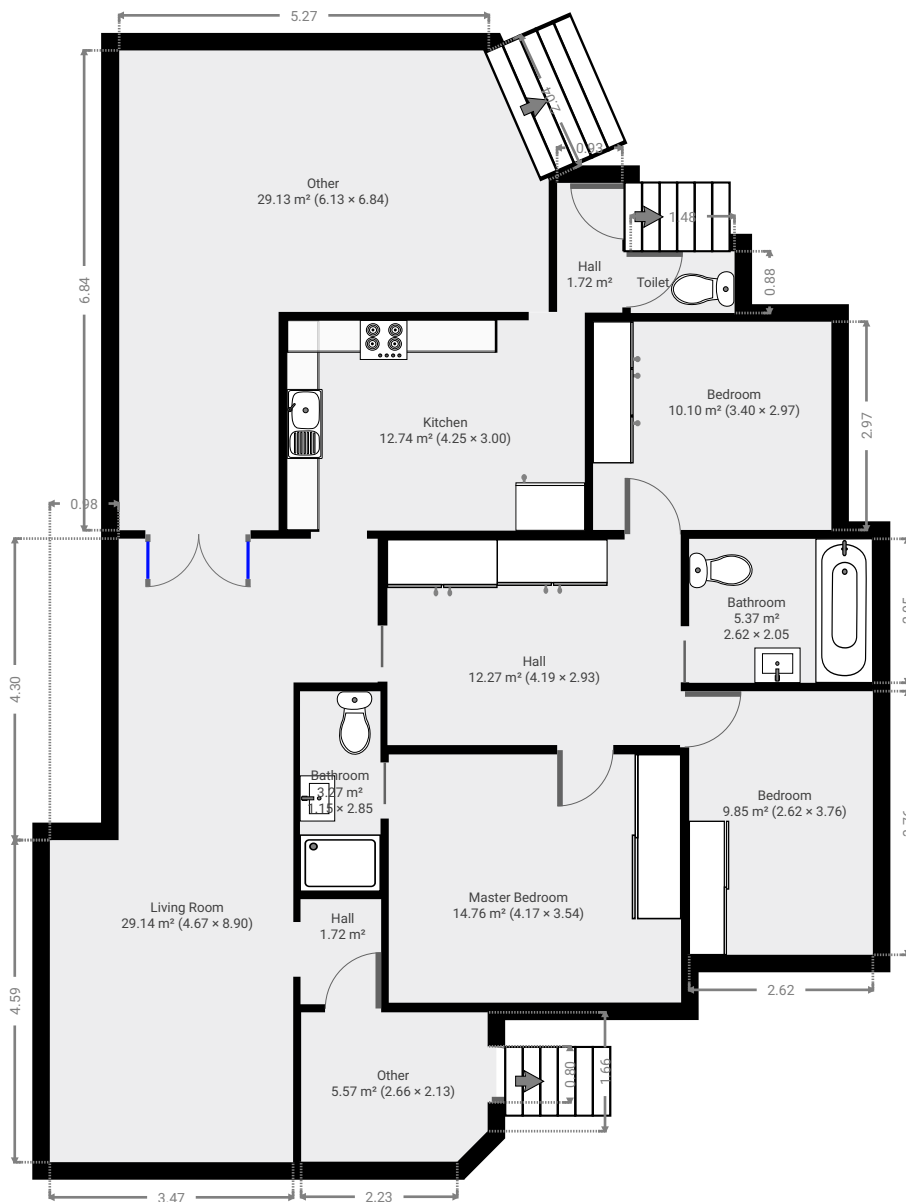
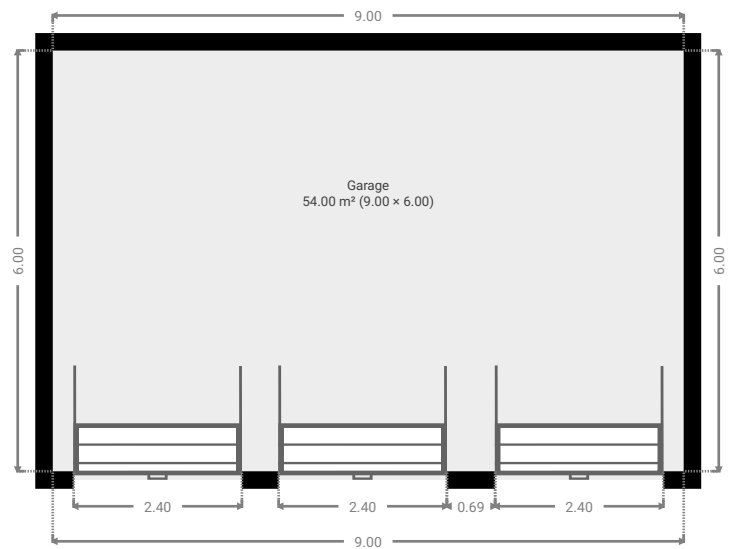

## ▼ Other Ground Floor

WIDTH: 2.66 m • LENGTH: 2.13 m  
AREA: 5.57 m<sup>2</sup> • PERIMETER: 9.33 m

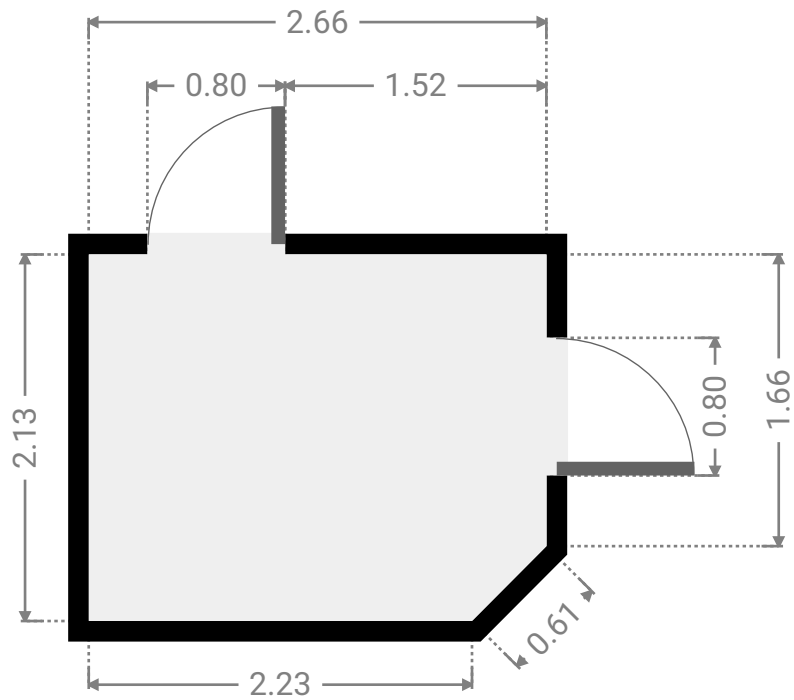

## ▼ Hall Ground Floor

WIDTH: 1.15 m • LENGTH: 1.50 m  
AREA: 1.72 m<sup>2</sup> • PERIMETER: 5.30 m

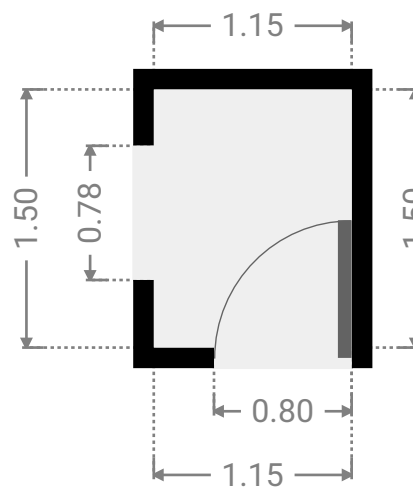
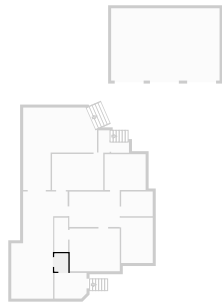

▼ Living Room  
Ground Floor

WIDTH: 4.67 m • LENGTH: 8.90 m  
AREA: 29.14 m<sup>2</sup> • PERIMETER: 27.14 m

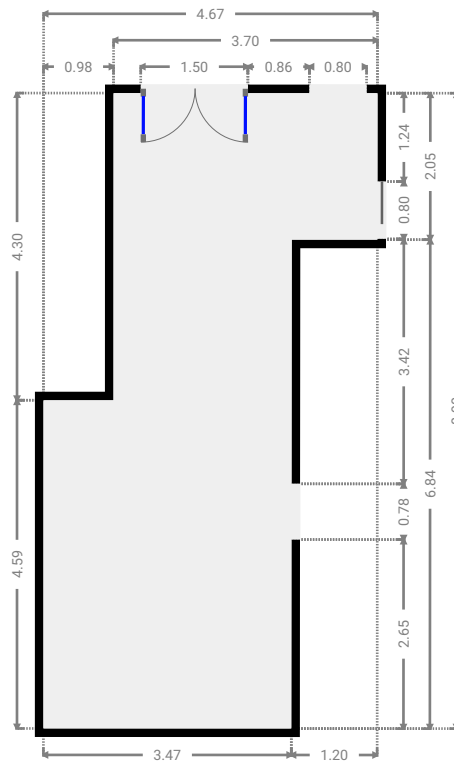
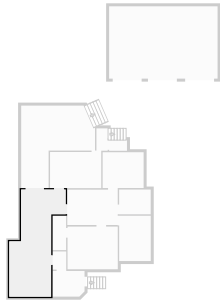

▼ Hall  
Ground Floor

WIDTH: 4.19 m • LENGTH: 2.93 m  
AREA: 12.27 m<sup>2</sup> • PERIMETER: 14.23 m

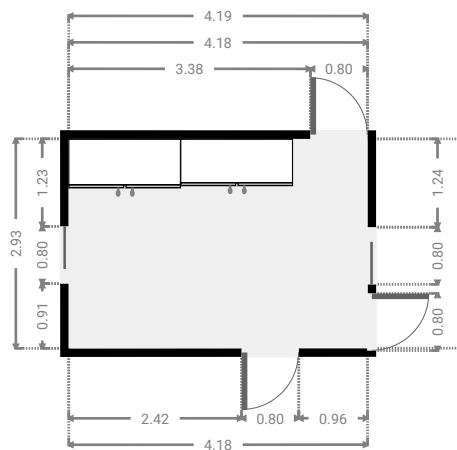
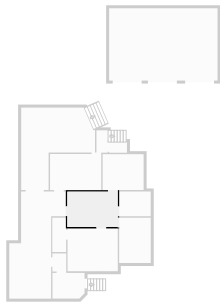

▼ **Bathroom**  
Ground Floor

WIDTH: 1.15 m • LENGTH: 2.85 m  
AREA: 3.27 m<sup>2</sup> • PERIMETER: 8.00 m

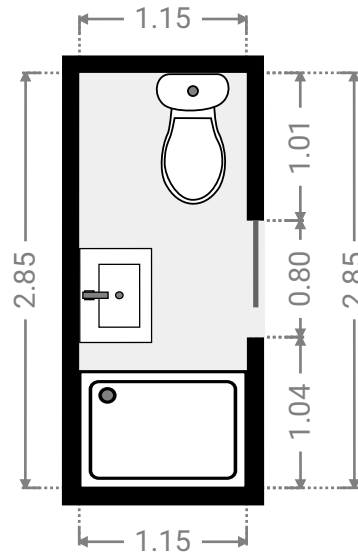
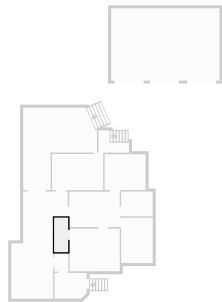

▼ **Master Bedroom**  
Ground Floor

WIDTH: 4.17 m • LENGTH: 3.54 m  
AREA: 14.76 m<sup>2</sup> • PERIMETER: 15.42 m

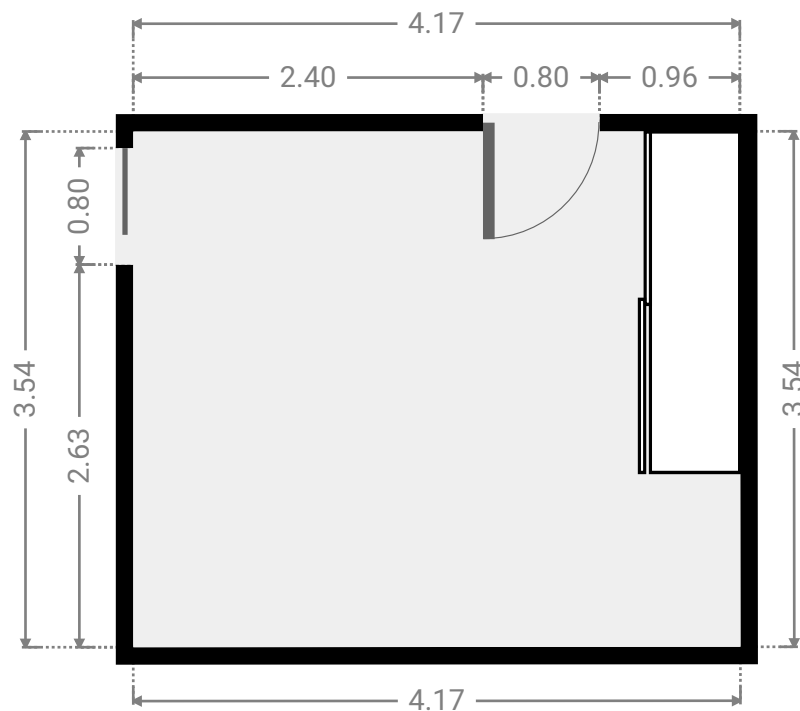
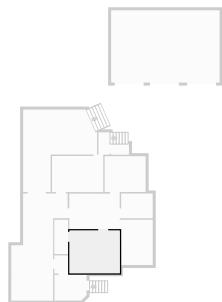

▼ **Bedroom**  
Ground Floor

WIDTH: 2.62 m • LENGTH: 3.76 m  
AREA: 9.85 m<sup>2</sup> • PERIMETER: 12.76 m

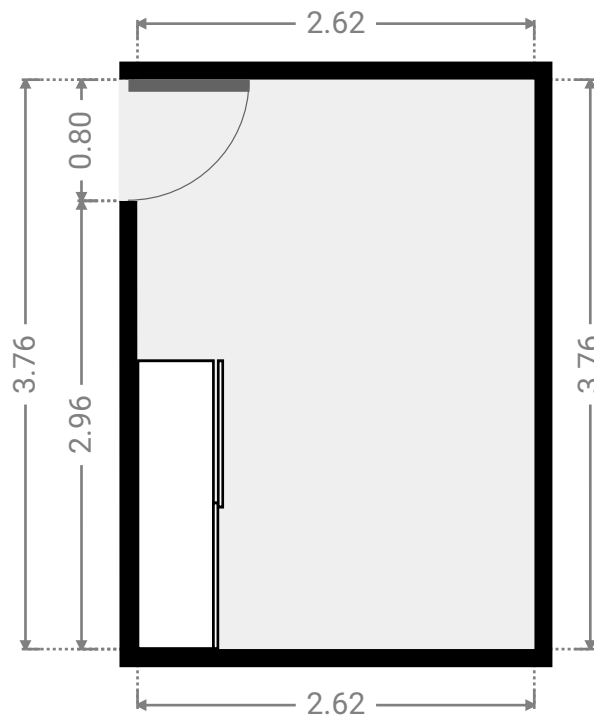

▼ **Bathroom**  
Ground Floor

WIDTH: 2.62 m • LENGTH: 2.05 m  
AREA: 5.37 m<sup>2</sup> • PERIMETER: 9.34 m

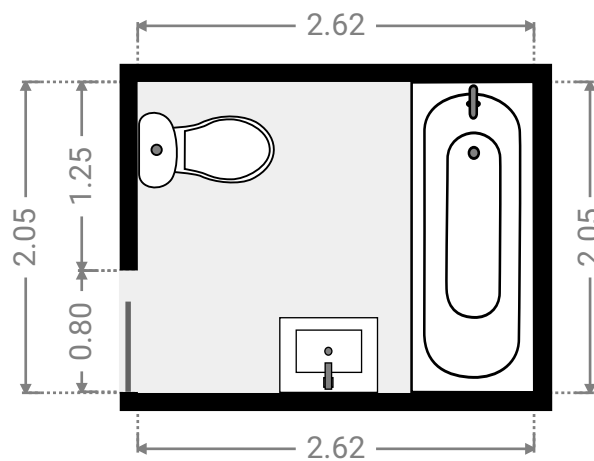
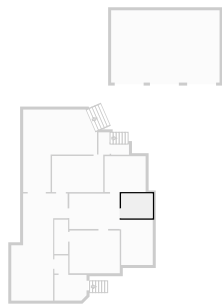

▼ **Bedroom**  
Ground Floor

WIDTH: 3.40 m • LENGTH: 2.97 m  
AREA: 10.10 m<sup>2</sup> • PERIMETER: 12.74 m

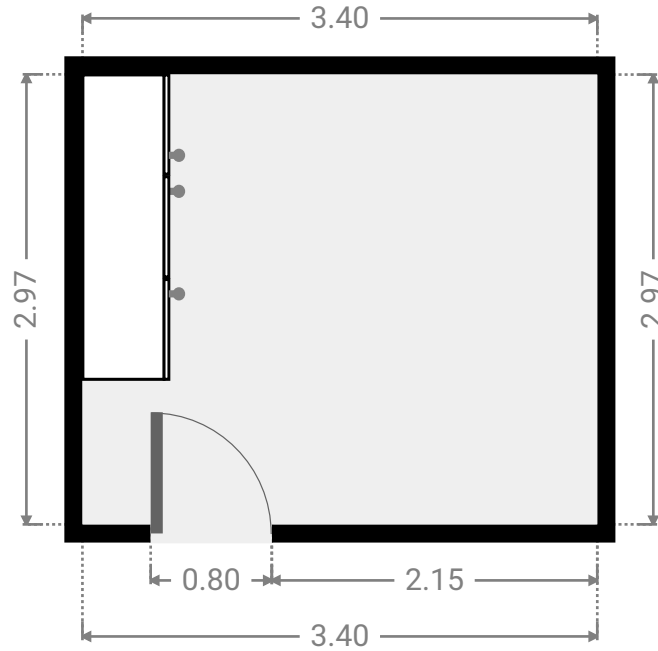
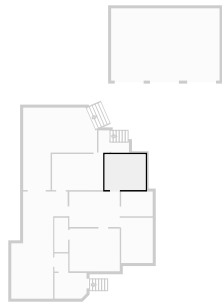

▼ **Kitchen**  
Ground Floor

WIDTH: 4.25 m • LENGTH: 3.00 m  
AREA: 12.74 m<sup>2</sup> • PERIMETER: 14.50 m

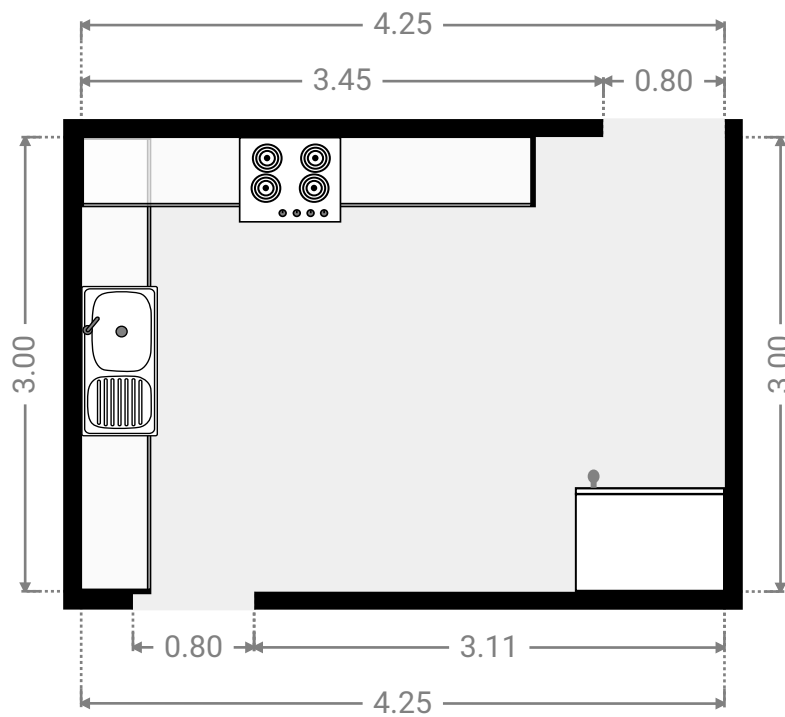
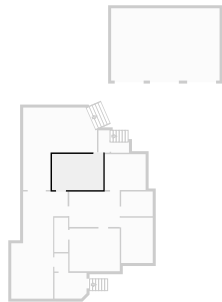

▼ **Hall**  
Ground Floor

WIDTH: 0.93 m • LENGTH: 1.85 m  
AREA: 1.72 m<sup>2</sup> • PERIMETER: 5.56 m

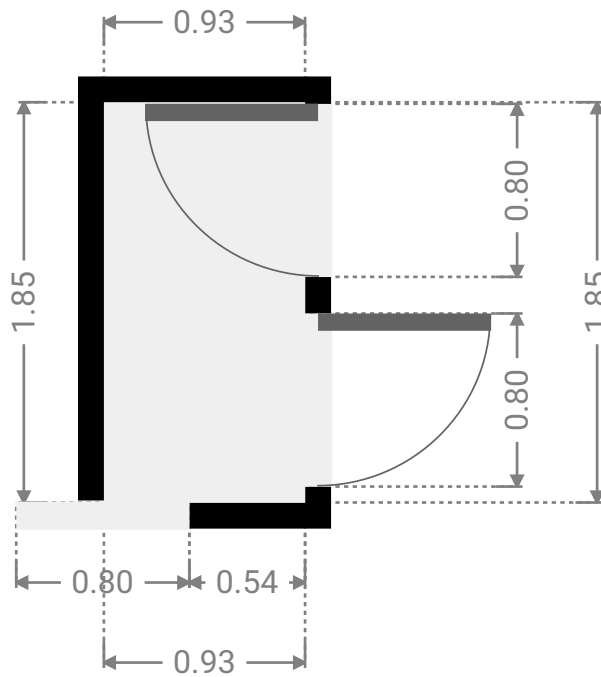
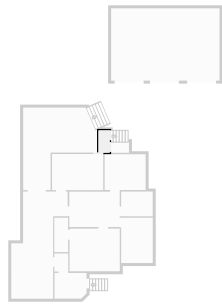

▼ **Toilet**  
Ground Floor

WIDTH: 1.48 m • LENGTH: 0.88 m  
AREA: 1.30 m<sup>2</sup> • PERIMETER: 4.72 m

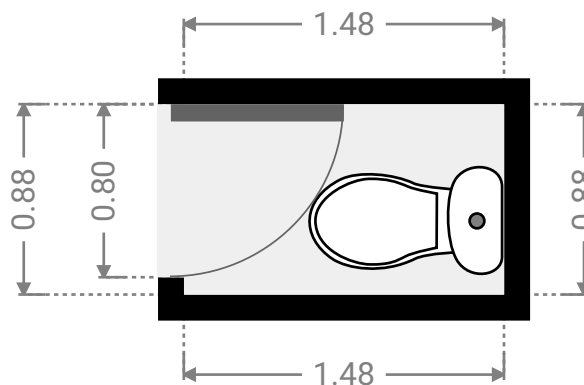
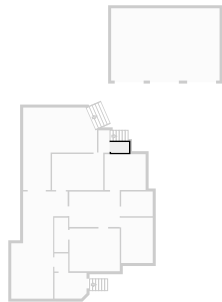



## ▼ Other Ground Floor

WIDTH: 6.13 m • LENGTH: 6.84 m  
AREA: 29.13 m<sup>2</sup> • PERIMETER: 25.27 m

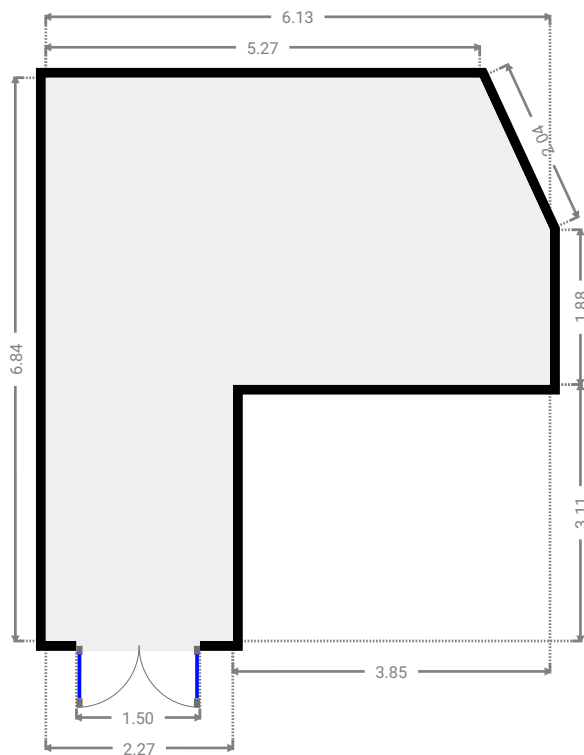
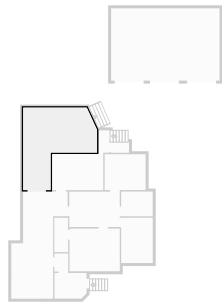

## ▼ Garage Ground Floor

WIDTH: 9.00 m • LENGTH: 6.00 m  
AREA: 54.00 m<sup>2</sup> • PERIMETER: 30.00 m

