

# 4 Frisch Street

## Ground Floor

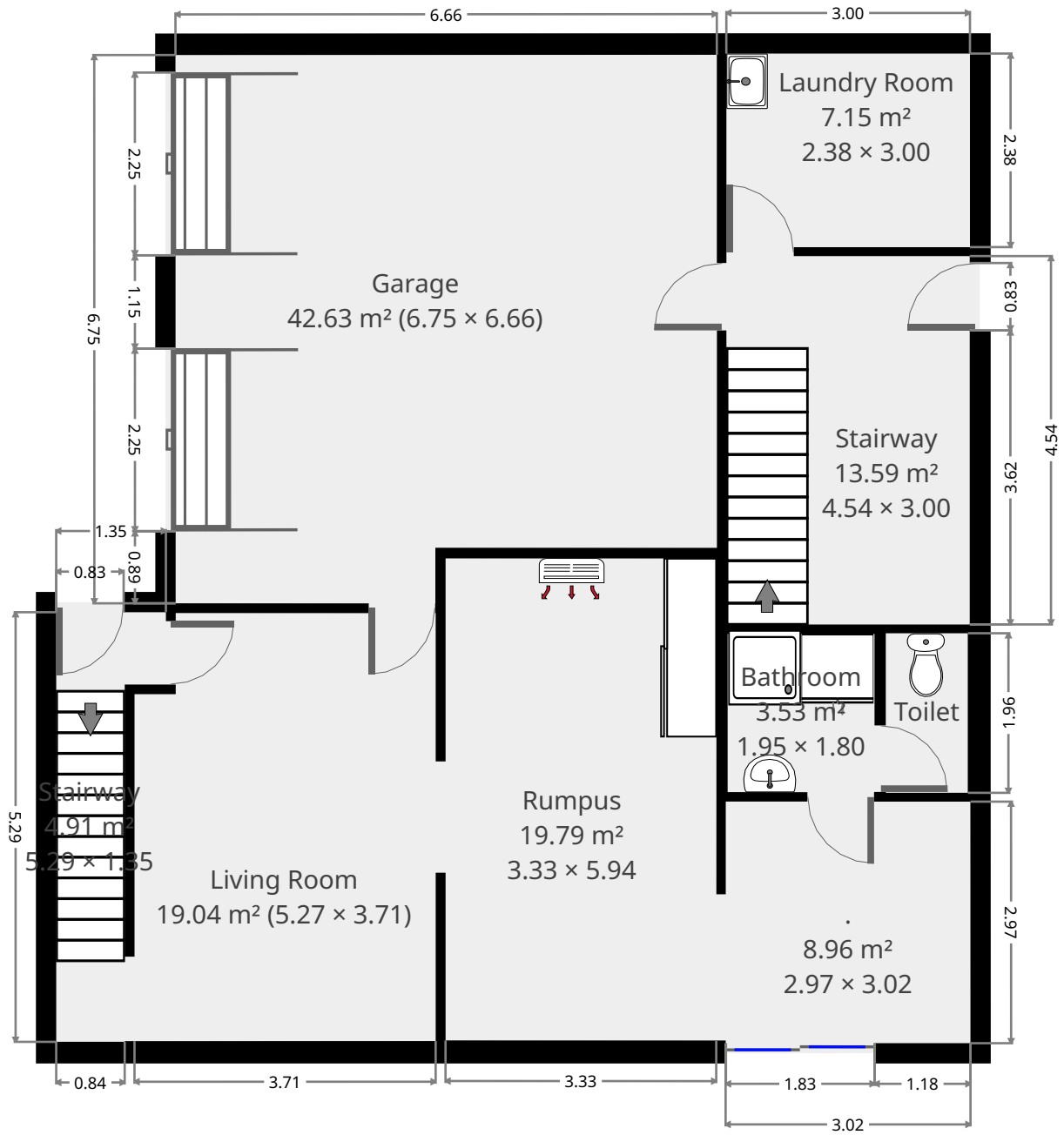

THIS FLOORPLAN IS PROVIDED WITHOUT WARRANTY OF ANY KIND. SENSOPIA DISCLAIMS ANY WARRANTY INCLUDING, WITHOUT LIMITATION, SATISFACTORY QUALITY OR ACCURACY OF DIMENSIONS.



# 4 Frisch Street

## Living Room

Width: 3.71 m  
 Length: 5.27 m  
 Area: 19.04 m<sup>2</sup>  
 Perimeter: 17.96 m

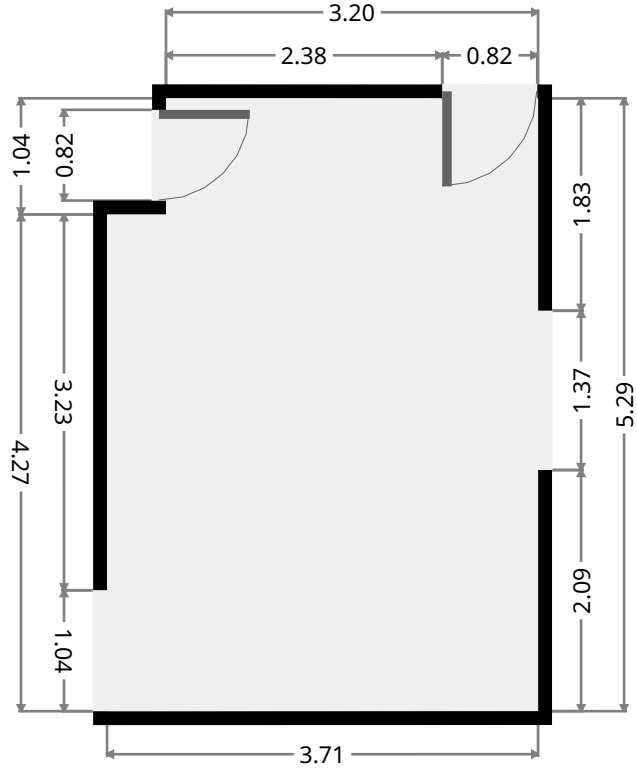
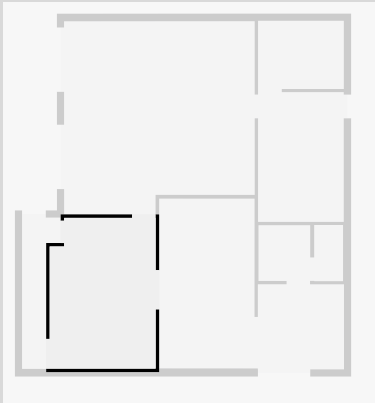

## Rumpus

Width: 3.33 m  
 Length: 5.94 m  
 Area: 19.79 m<sup>2</sup>  
 Perimeter: 18.54 m

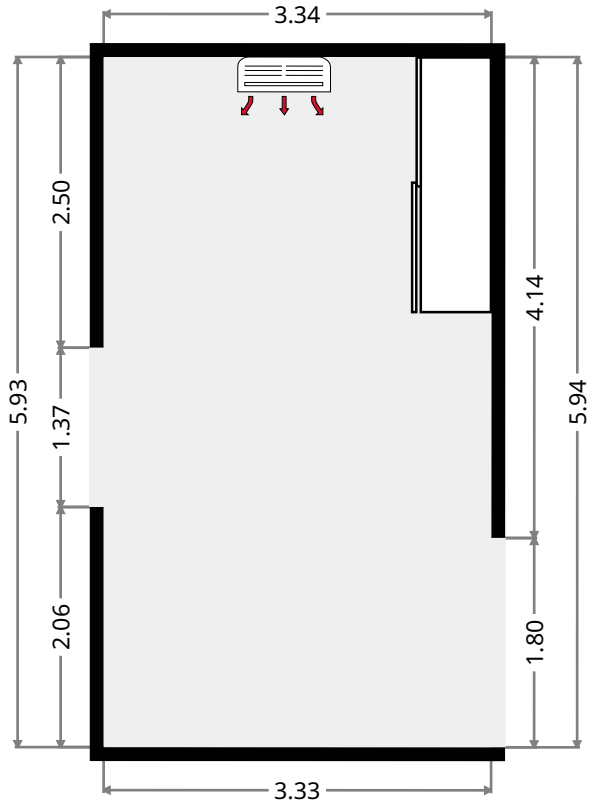
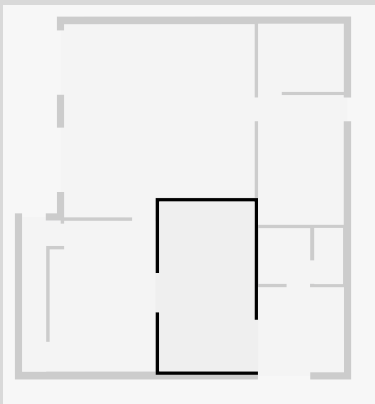

THIS FLOORPLAN IS PROVIDED WITHOUT WARRANTY OF ANY KIND. SENSOPIA DISCLAIMS ANY WARRANTY INCLUDING, WITHOUT LIMITATION, SATISFACTORY QUALITY OR ACCURACY OF DIMENSIONS.

# 4 Frisch Street

•  
 Width: 2.97 m  
 Length: 3.02 m  
 Area: 8.96 m<sup>2</sup>  
 Perimeter: 11.98 m

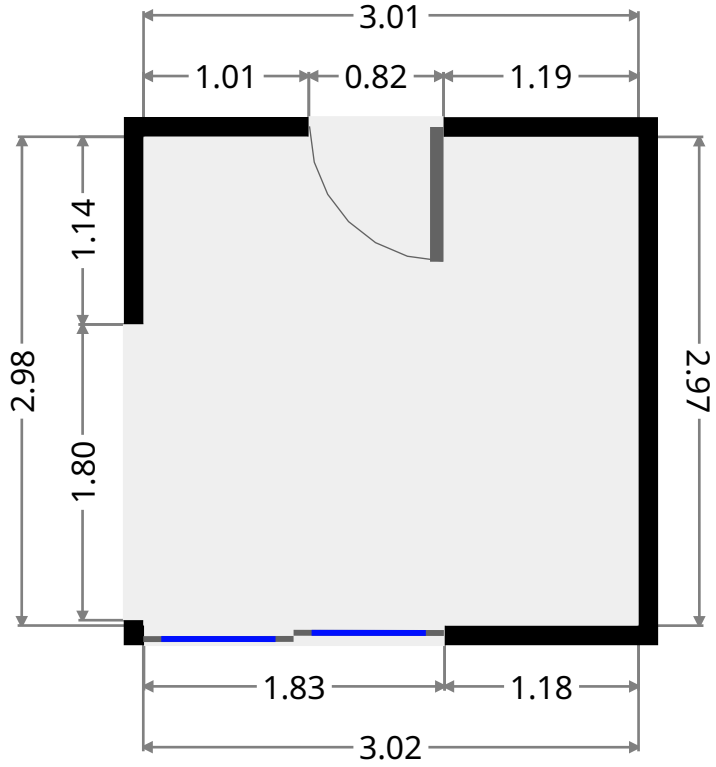
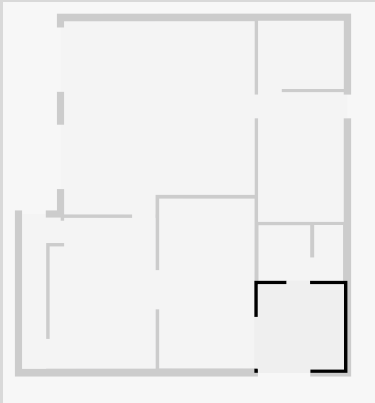

## Toilet

Width: 1.00 m  
 Length: 1.96 m  
 Area: 1.98 m<sup>2</sup>  
 Perimeter: 5.95 m

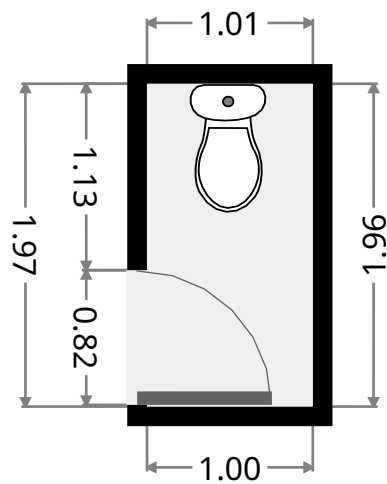
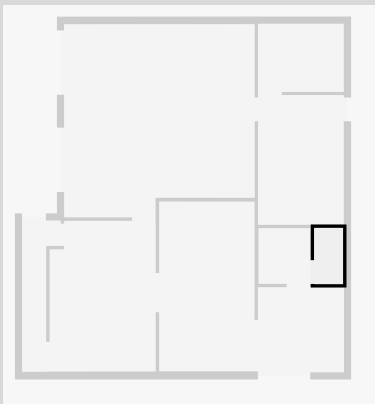

# 4 Frisch Street

## Bathroom

Width: 1.80 m  
 Length: 1.95 m  
 Area: 3.53 m<sup>2</sup>  
 Perimeter: 7.52 m

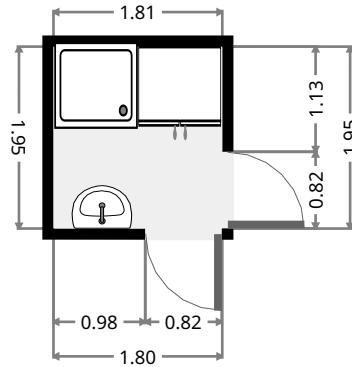
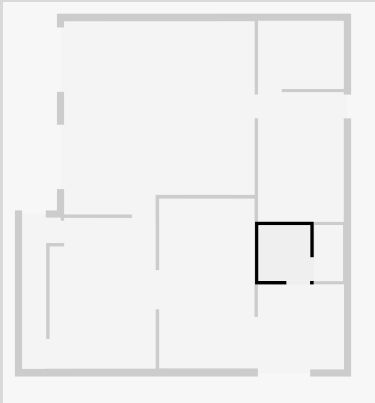

## Garage

Width: 6.66 m  
 Length: 6.75 m  
 Area: 42.63 m<sup>2</sup>  
 Perimeter: 26.83 m

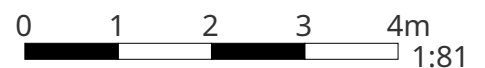
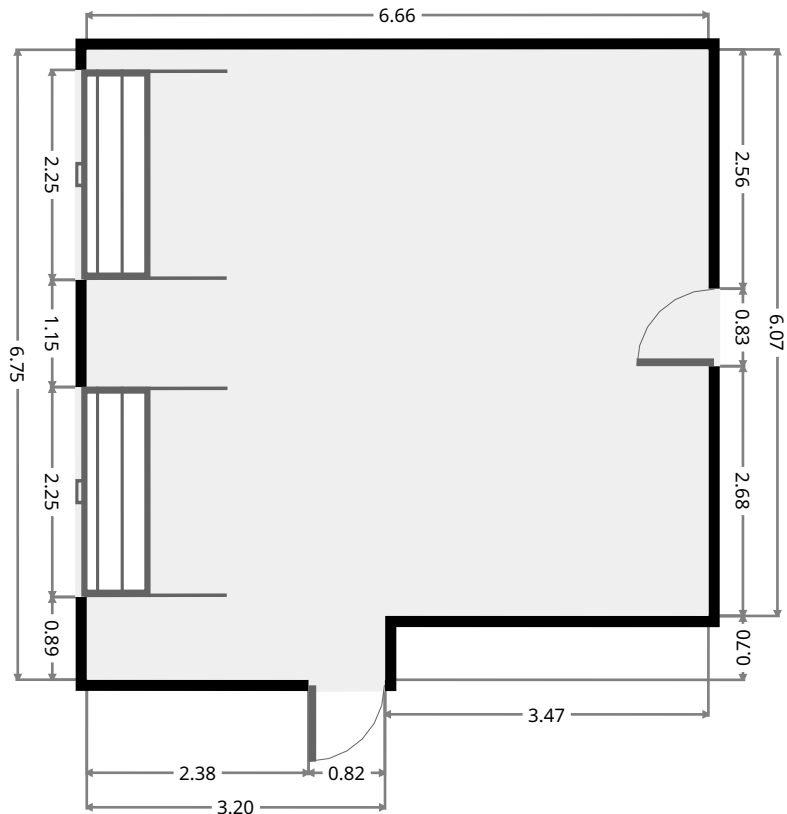
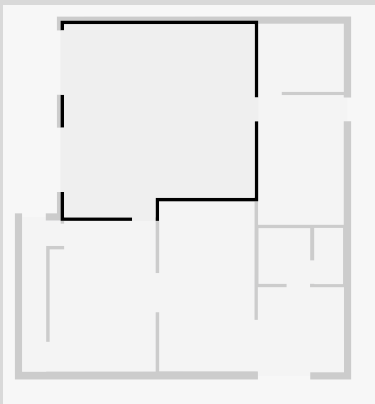

THIS FLOORPLAN IS PROVIDED WITHOUT WARRANTY OF ANY KIND. SENSOPIA DISCLAIMS ANY WARRANTY INCLUDING, WITHOUT LIMITATION, SATISFACTORY QUALITY OR ACCURACY OF DIMENSIONS.

# 4 Frisch Street

## Stairway

Width: 3.00 m  
 Length: 4.54 m  
 Area: 13.59 m<sup>2</sup>  
 Perimeter: 15.06 m

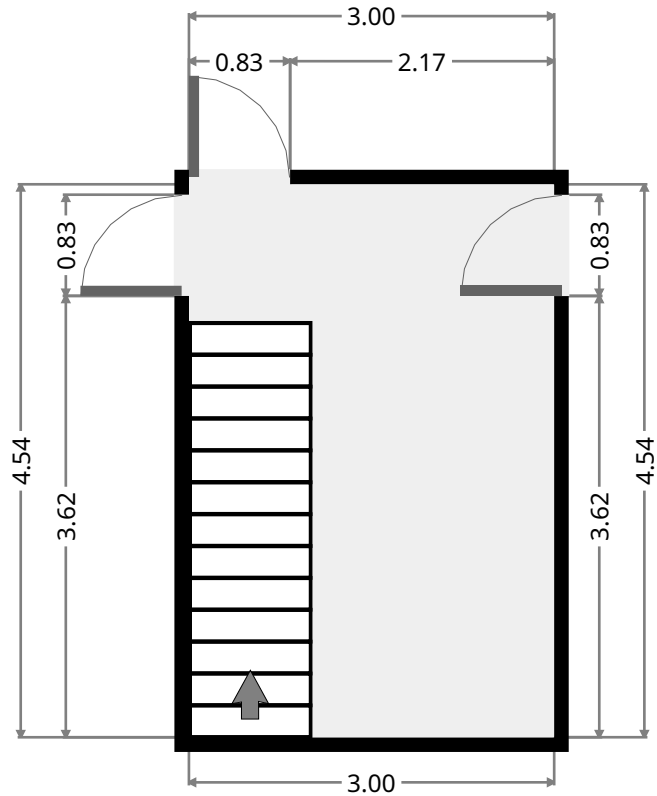
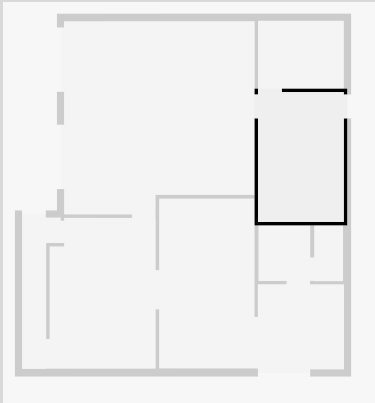

## Laundry Room

Width: 2.38 m  
 Length: 3.00 m  
 Area: 7.15 m<sup>2</sup>  
 Perimeter: 10.76 m

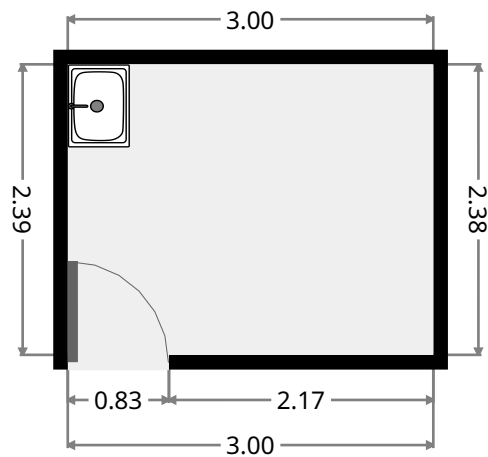
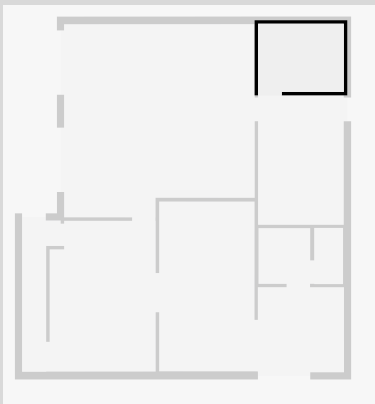

# 4 Frisch Street

## Stairway

Width: 1.35 m  
Length: 5.29 m  
Area: 4.91 m<sup>2</sup>  
Perimeter: 13.28 m

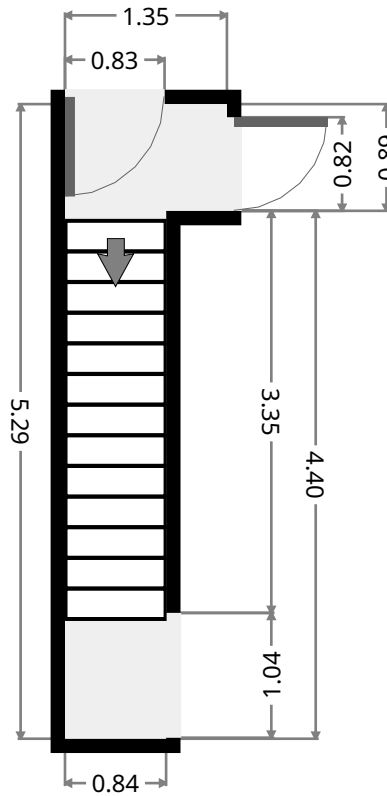
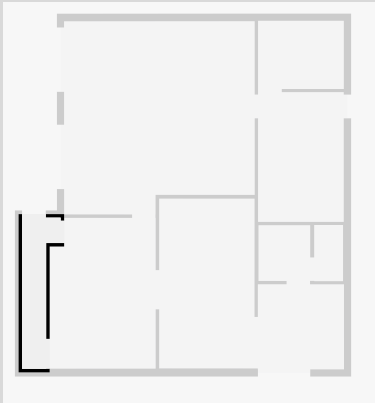

# 4 Frisch Street

## 1st Floor

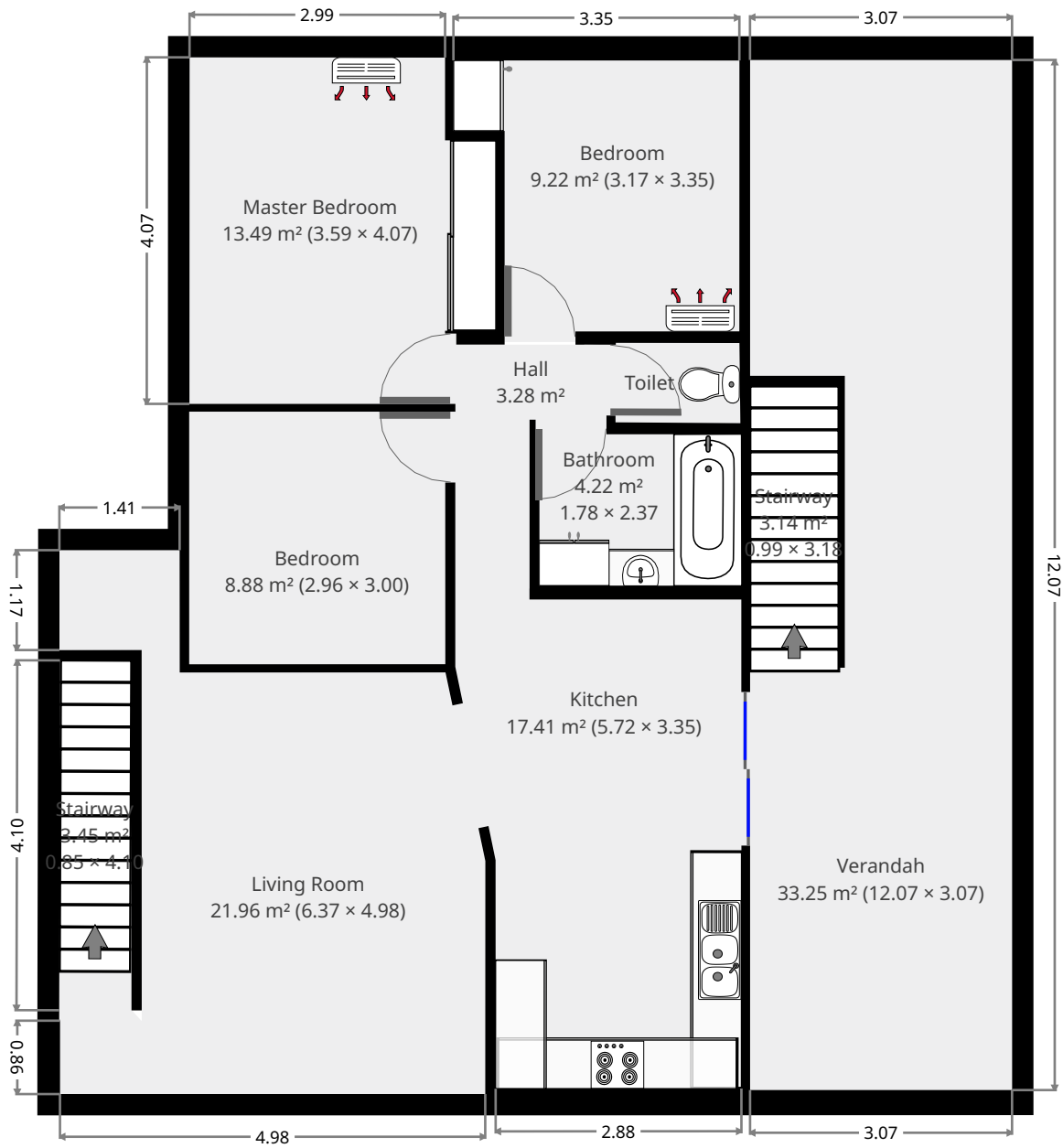

THIS FLOORPLAN IS PROVIDED WITHOUT WARRANTY OF ANY KIND. SENSOPIA DISCLAIMS ANY WARRANTY INCLUDING, WITHOUT LIMITATION, SATISFACTORY QUALITY OR ACCURACY OF DIMENSIONS.



# 4 Frisch Street

## Living Room

Width: 4.98 m  
 Length: 6.37 m  
 Area: 21.96 m<sup>2</sup>  
 Perimeter: 24.22 m

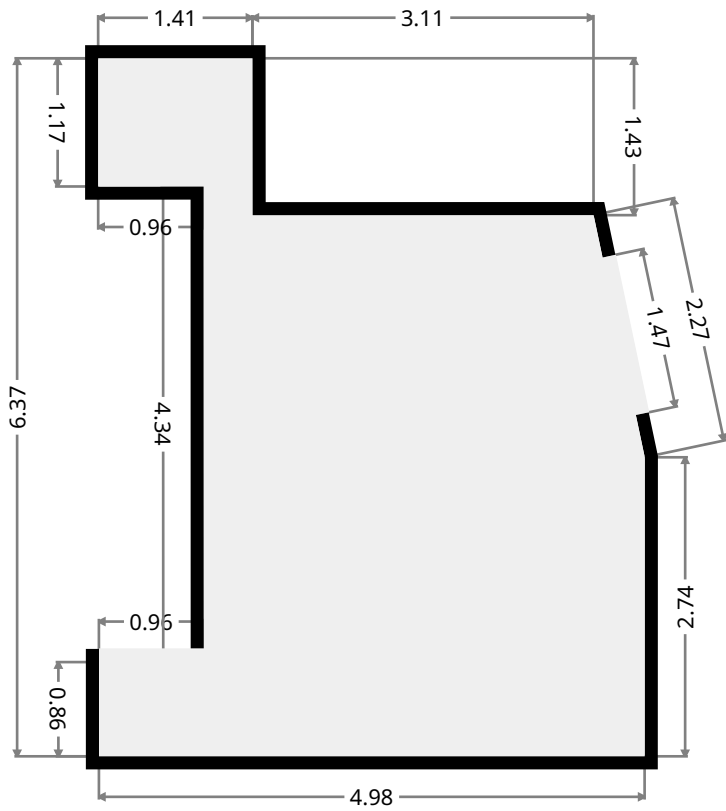
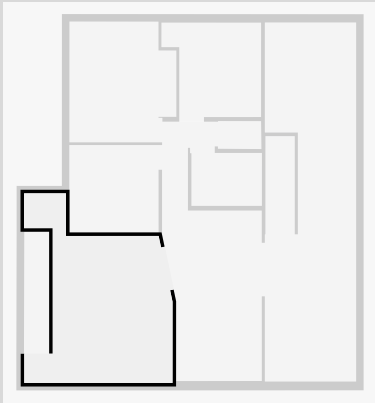

## Stairway

Width: 0.85 m  
 Length: 4.10 m  
 Area: 3.45 m<sup>2</sup>  
 Perimeter: 9.88 m

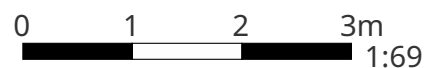
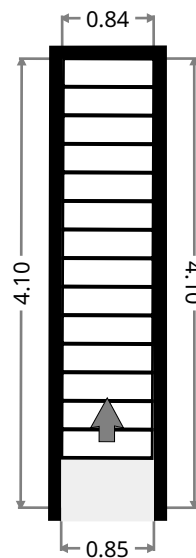
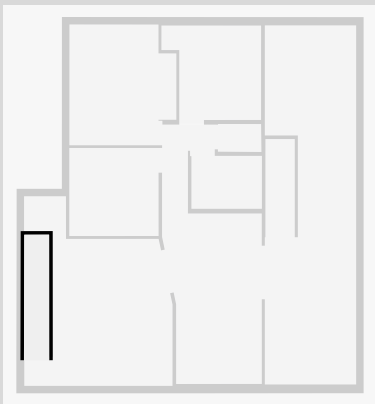

THIS FLOORPLAN IS PROVIDED WITHOUT WARRANTY OF ANY KIND. SENSOPIA DISCLAIMS ANY WARRANTY INCLUDING, WITHOUT LIMITATION, SATISFACTORY QUALITY OR ACCURACY OF DIMENSIONS.



# 4 Frisch Street

## Kitchen

Width: 3.35 m  
 Length: 5.72 m  
 Area: 17.41 m<sup>2</sup>  
 Perimeter: 17.74 m

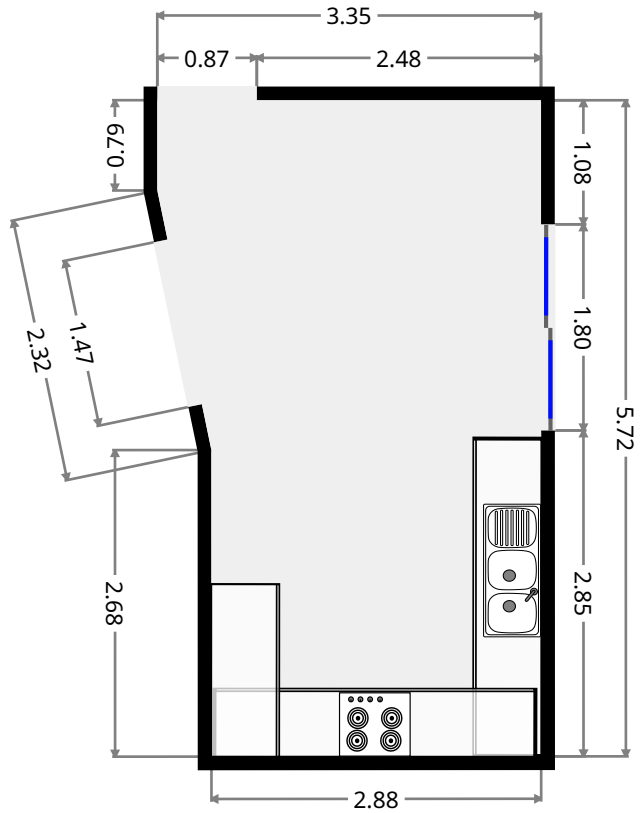
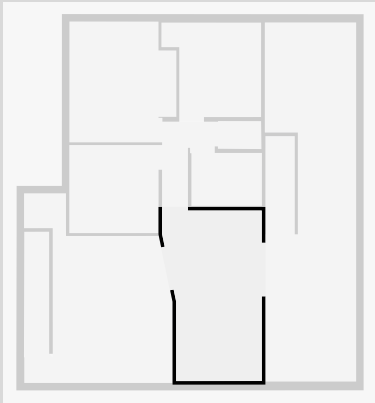

## Hall

Width: 1.77 m  
 Length: 2.86 m  
 Area: 3.28 m<sup>2</sup>  
 Perimeter: 9.26 m

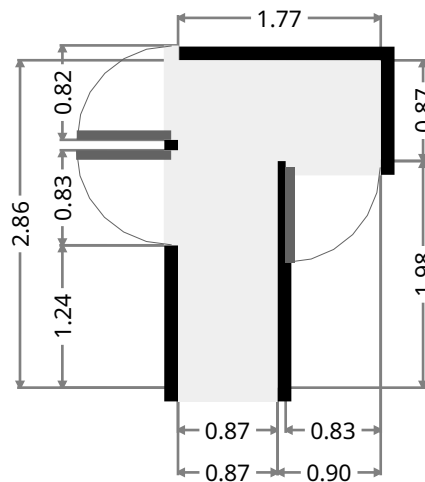
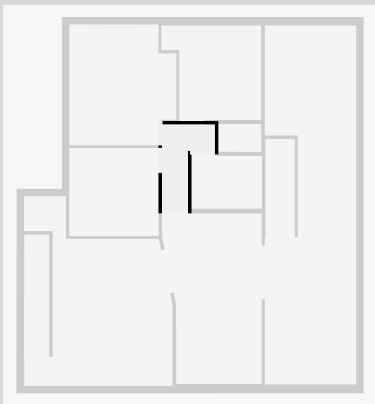

# 4 Frisch Street

## Bedroom

Width: 2.96 m  
 Length: 3.00 m  
 Area: 8.88 m<sup>2</sup>  
 Perimeter: 11.92 m

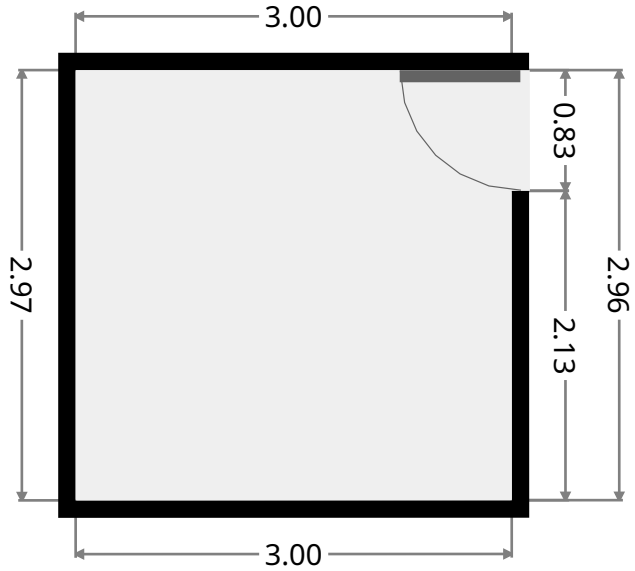
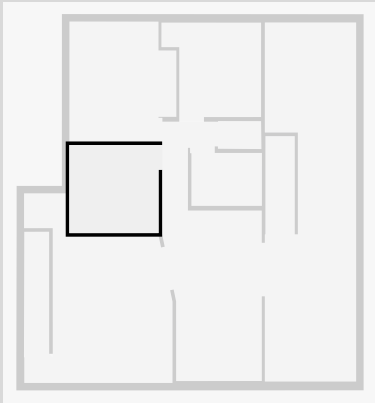

## Master Bedroom

Width: 3.59 m  
 Length: 4.07 m  
 Area: 13.49 m<sup>2</sup>  
 Perimeter: 15.31 m

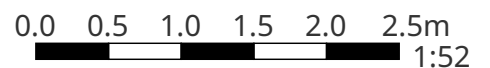
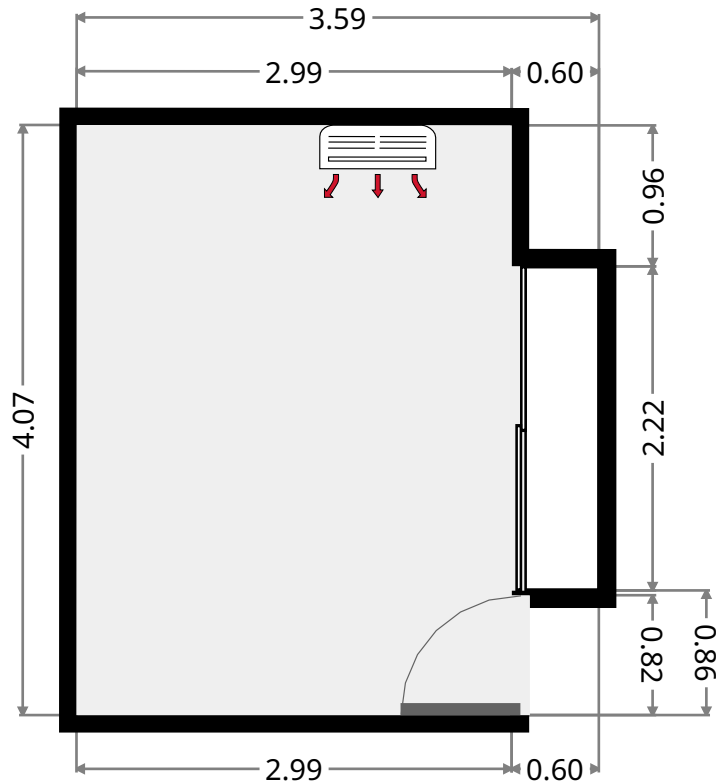
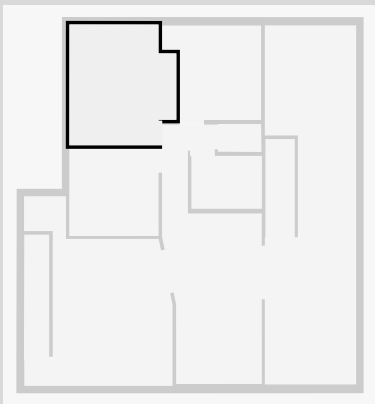

THIS FLOORPLAN IS PROVIDED WITHOUT WARRANTY OF ANY KIND. SENSOPIA DISCLAIMS ANY WARRANTY INCLUDING, WITHOUT LIMITATION, SATISFACTORY QUALITY OR ACCURACY OF DIMENSIONS.

# 4 Frisch Street

## Bedroom

Width: 3.17 m  
 Length: 3.35 m  
 Area: 9.22 m<sup>2</sup>  
 Perimeter: 13.05 m

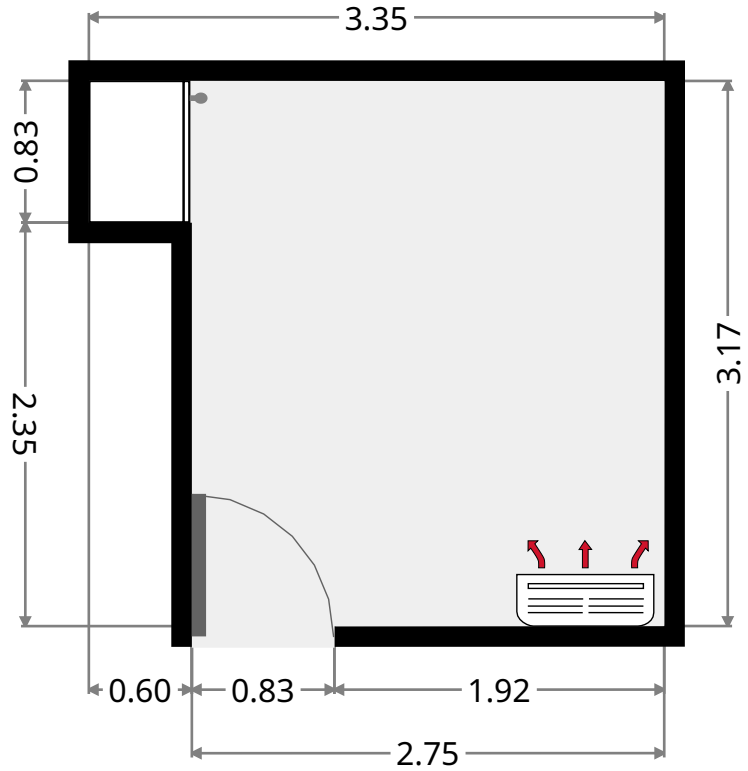
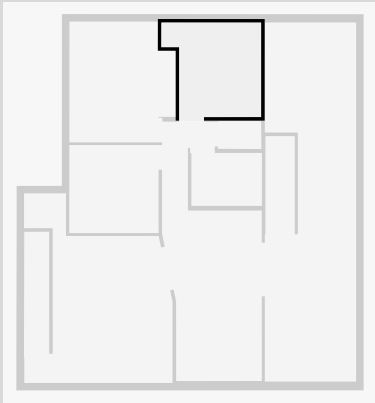

## Bathroom

Width: 1.78 m  
 Length: 2.37 m  
 Area: 4.22 m<sup>2</sup>  
 Perimeter: 8.30 m

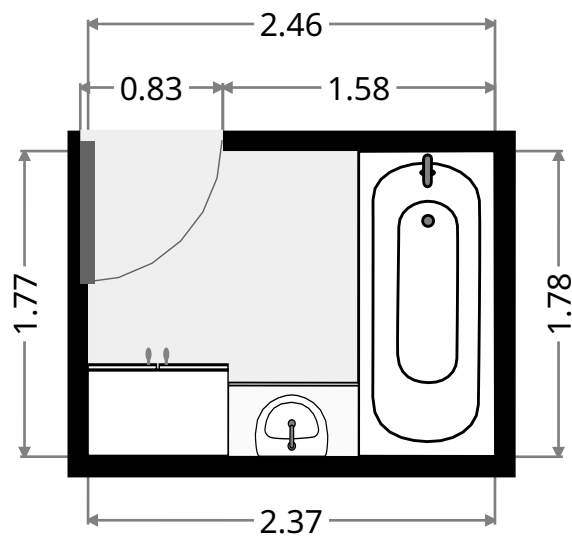
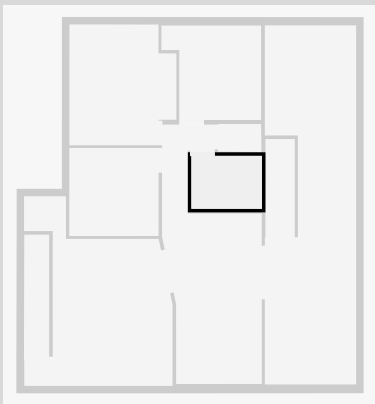

# 4 Frisch Street

## Toilet

Width: 0.93 m  
Length: 1.46 m  
Area: 1.36 m<sup>2</sup>  
Perimeter: 4.78 m

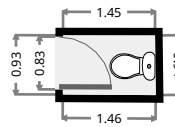
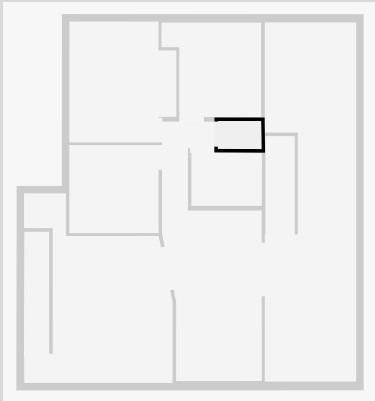

## Verandah

Width: 3.07 m  
Length: 12.07 m  
Area: 33.25 m<sup>2</sup>  
Perimeter: 32.50 m

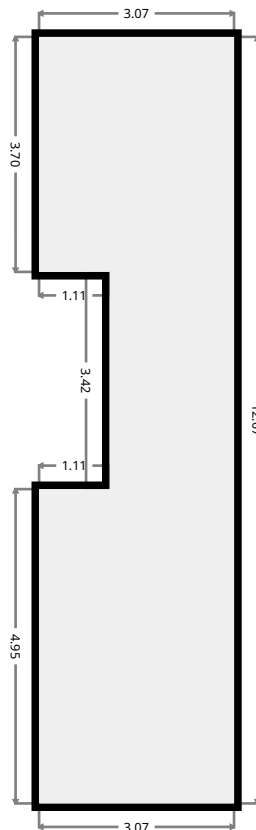
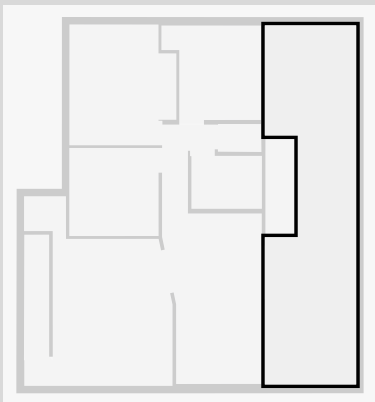

THIS FLOORPLAN IS PROVIDED WITHOUT WARRANTY OF ANY KIND. SENSOPIA DISCLAIMS ANY WARRANTY INCLUDING, WITHOUT LIMITATION, SATISFACTORY QUALITY OR ACCURACY OF DIMENSIONS.

# 4 Frisch Street

## Stairway

Width: 0.99 m  
Length: 3.18 m  
Area: 3.14 m<sup>2</sup>  
Perimeter: 8.33 m

