

4 Clara Place

Created on
2021-02-09

Floors
2

▼ Ground Floor

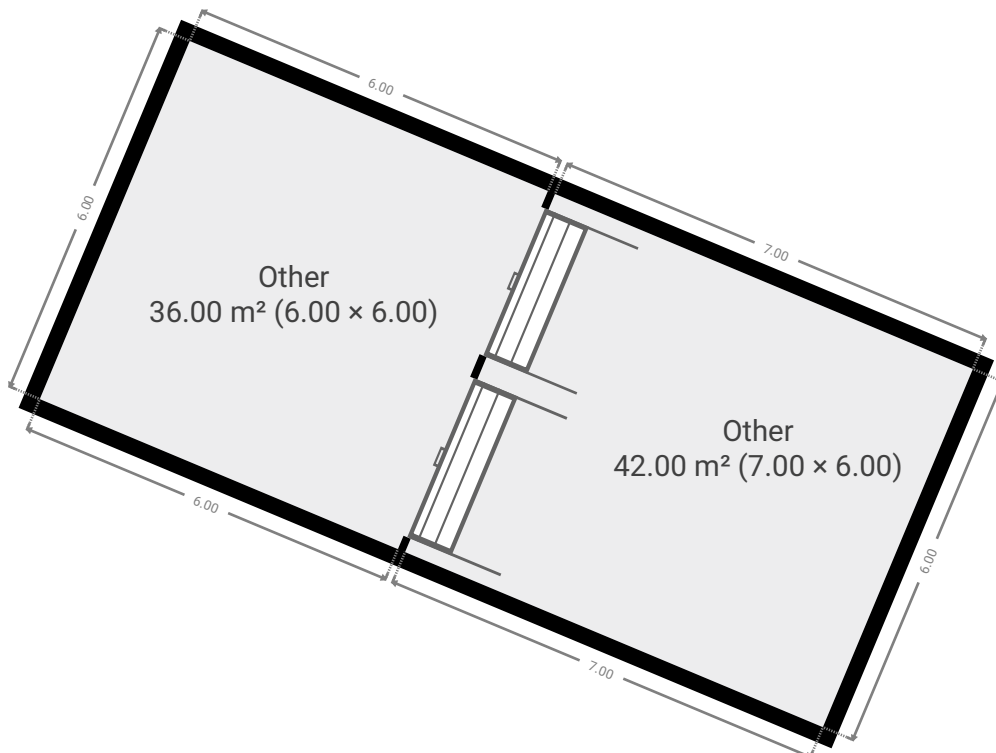
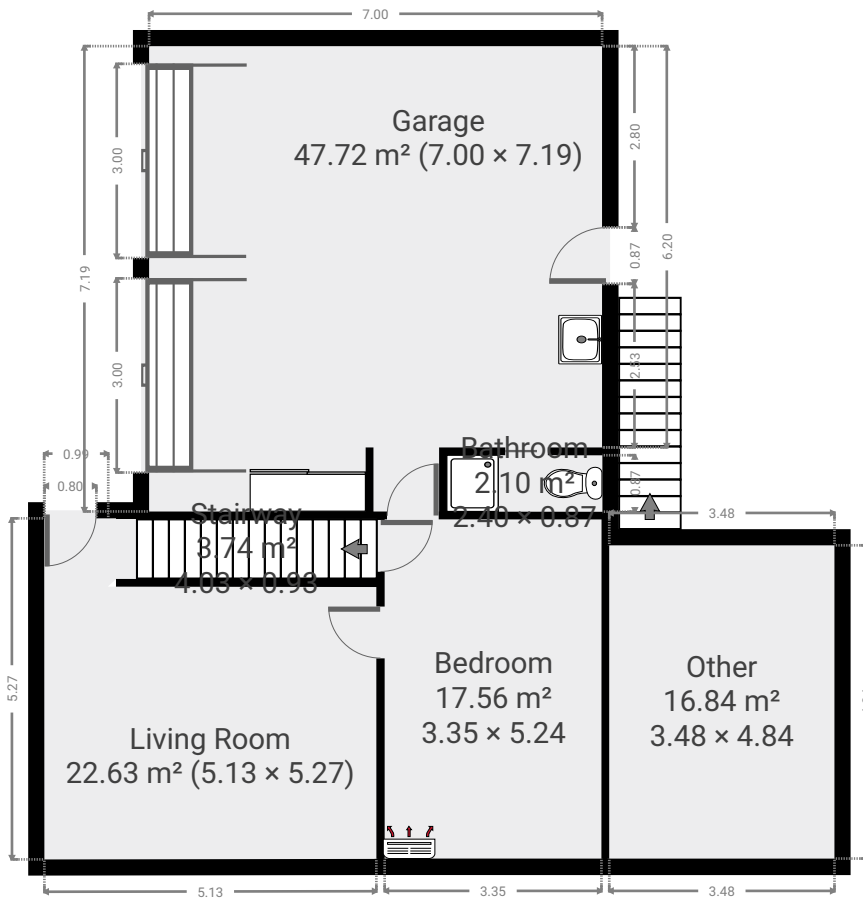

▼ Living Room Ground Floor

WIDTH: 5.27 m • LENGTH: 5.13 m
AREA: 22.63 m² • PERIMETER: 20.79 m

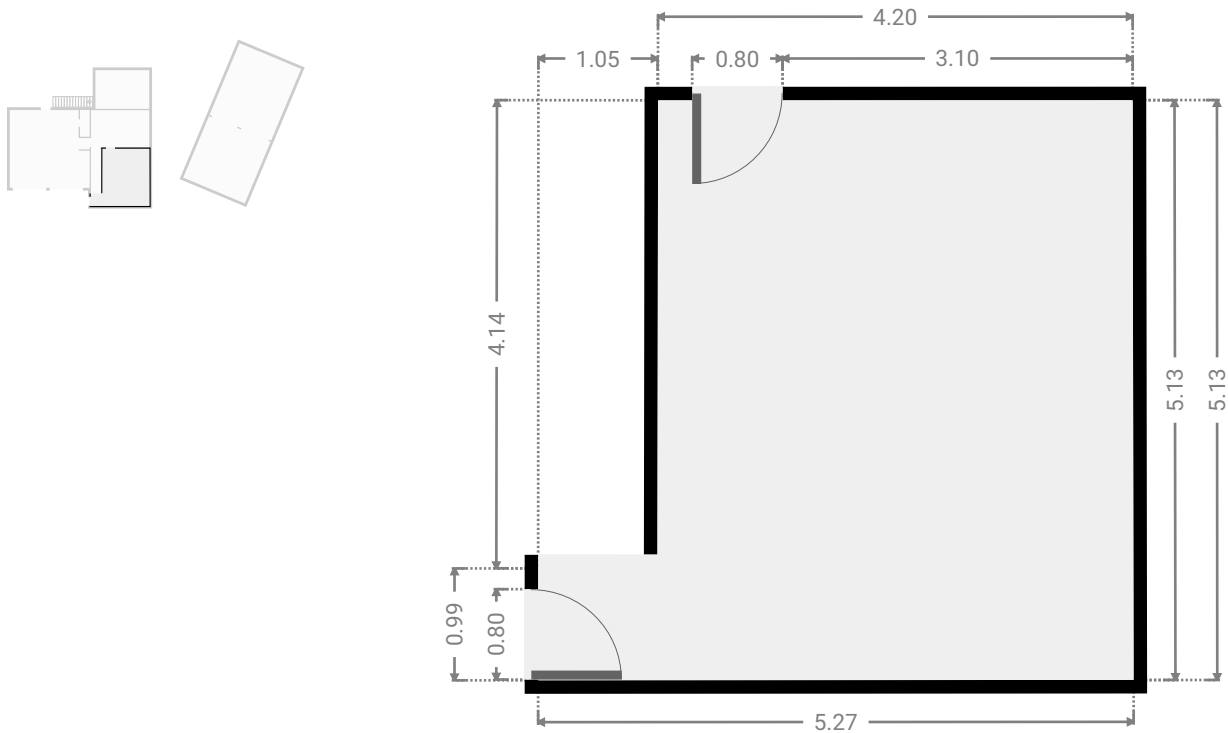

▼ Stairway Ground Floor

WIDTH: 0.93 m • LENGTH: 4.03 m
AREA: 3.74 m² • PERIMETER: 9.92 m

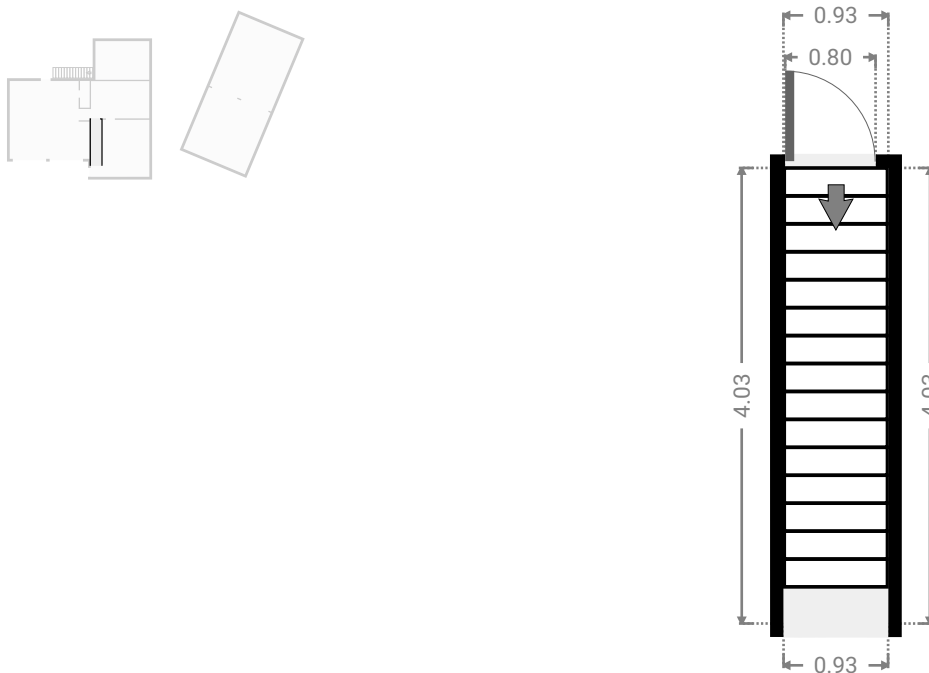

▼ Bedroom Ground Floor

WIDTH: 5.24 m • LENGTH: 3.35 m
AREA: 17.56 m² • PERIMETER: 17.18 m

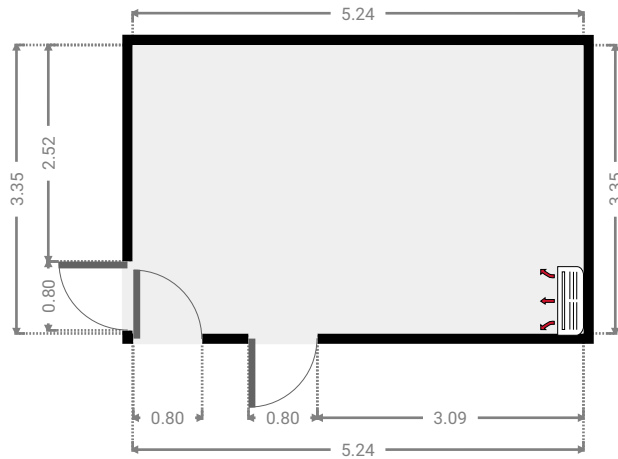
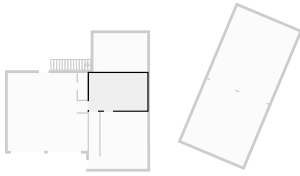

▼ Garage Ground Floor

WIDTH: 7.19 m • LENGTH: 7.00 m
AREA: 47.72 m² • PERIMETER: 30.36 m

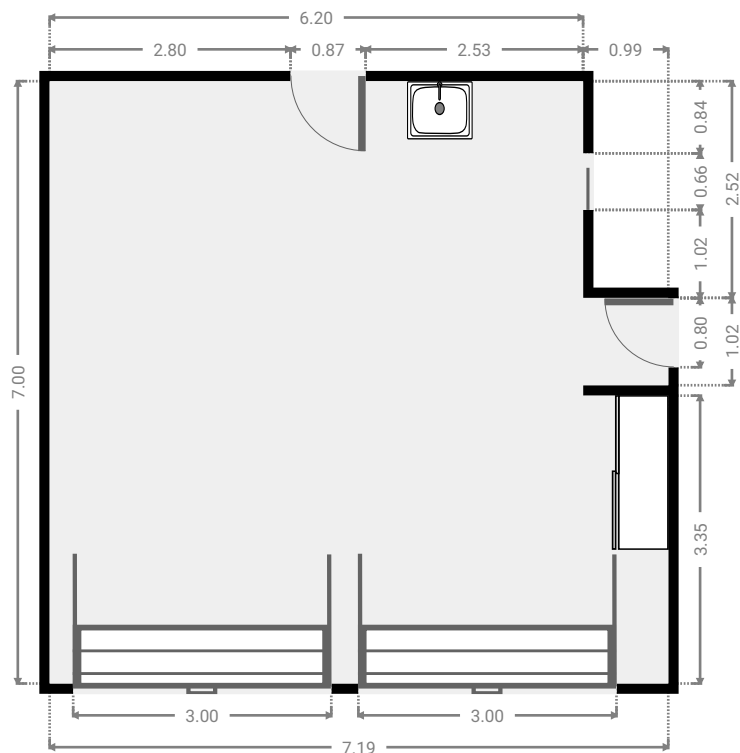
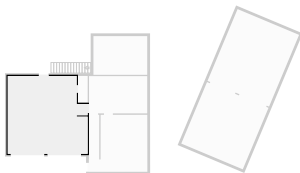

▼ Bathroom Ground Floor

WIDTH: 0.87 m • LENGTH: 2.40 m
AREA: 2.10 m² • PERIMETER: 6.55 m

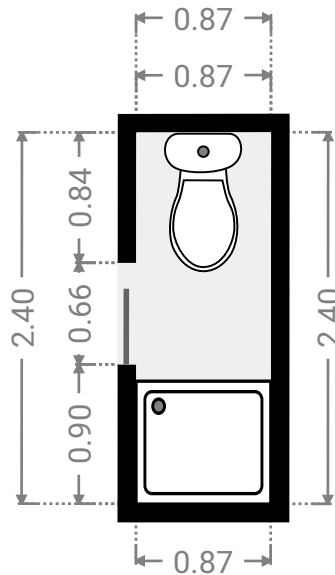
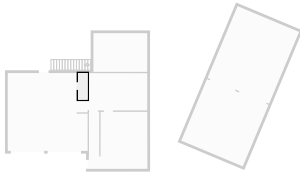

▼ Other Ground Floor

WIDTH: 4.84 m • LENGTH: 3.48 m
AREA: 16.84 m² • PERIMETER: 16.64 m

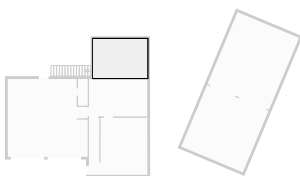

▼ Other
Ground Floor

WIDTH: 6.00 m • LENGTH: 6.00 m
AREA: 36.00 m² • PERIMETER: 24.00 m

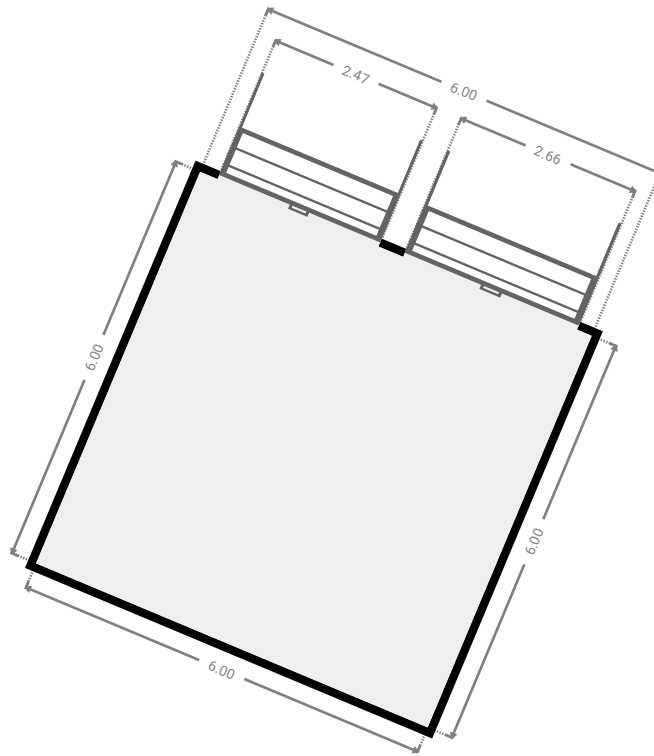
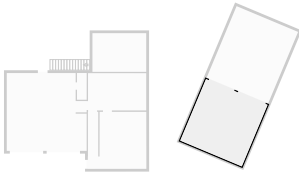

▼ Other
Ground Floor

WIDTH: 6.00 m • LENGTH: 7.00 m
AREA: 42.00 m² • PERIMETER: 26.00 m

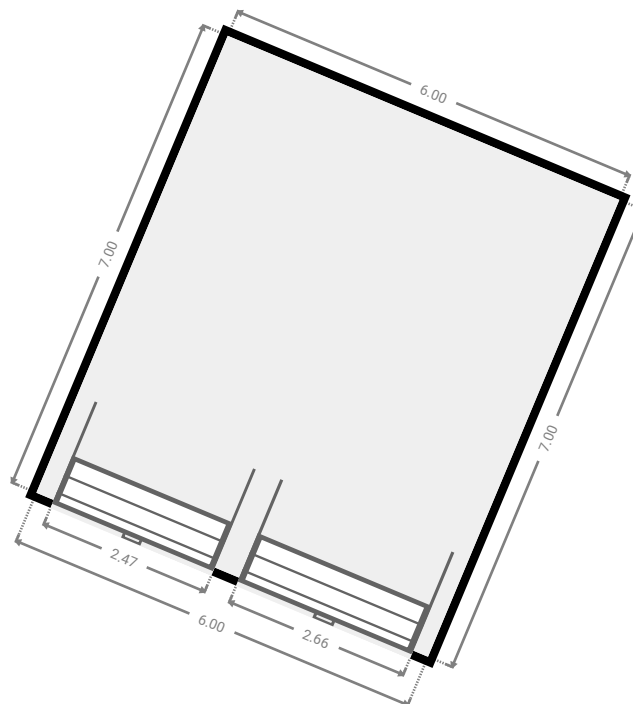
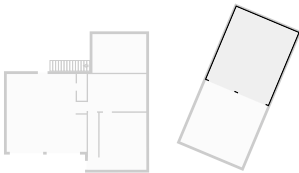

▼ 1st Floor

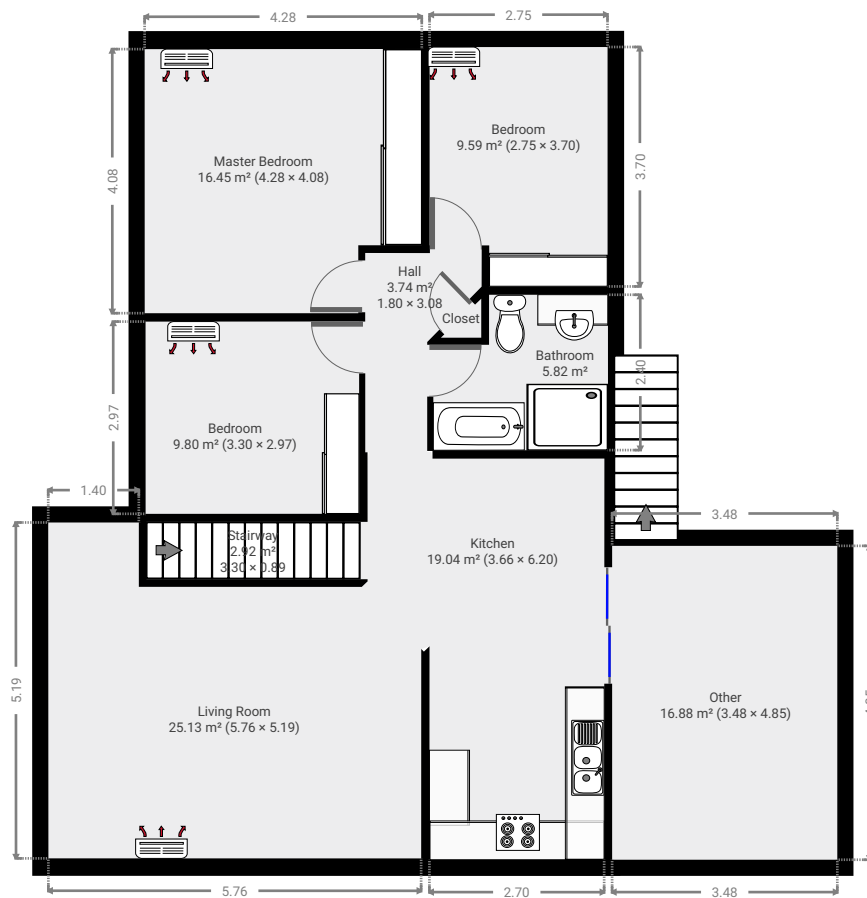

▼ Living Room 1st Floor

WIDTH: 5.19 m • LENGTH: 5.76 m
AREA: 25.13 m² • PERIMETER: 21.35 m

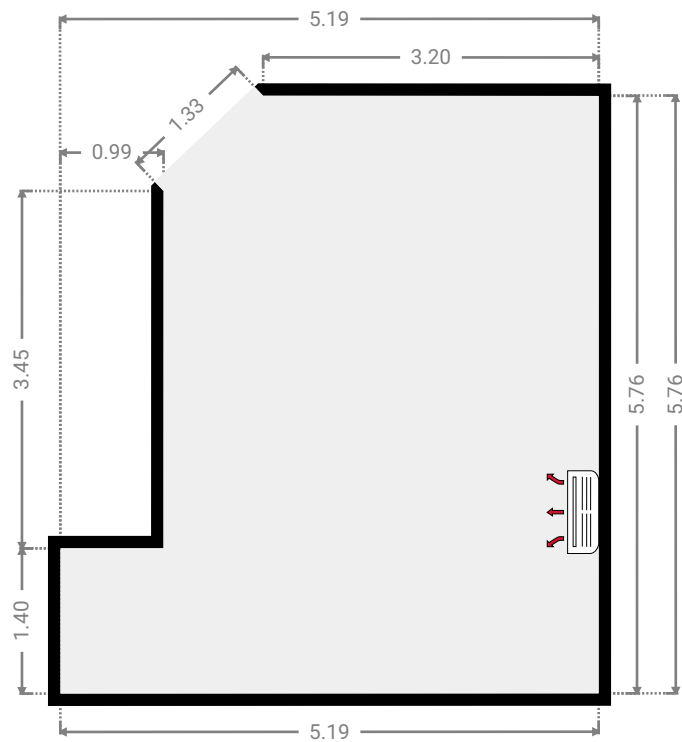
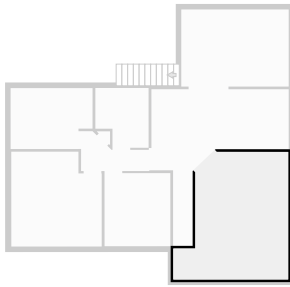

▼ Stairway 1st Floor

WIDTH: 0.89 m • LENGTH: 3.30 m
AREA: 2.92 m² • PERIMETER: 8.36 m

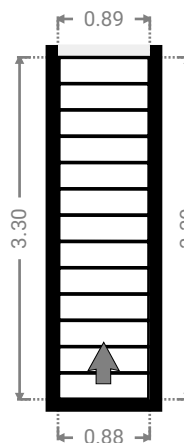
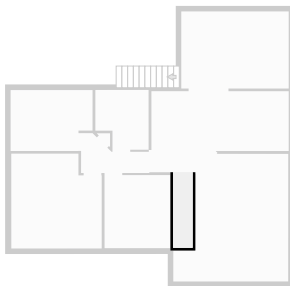

▼ Kitchen
1st Floor

WIDTH: 6.20 m • LENGTH: 3.66 m
AREA: 19.04 m² • PERIMETER: 19.14 m

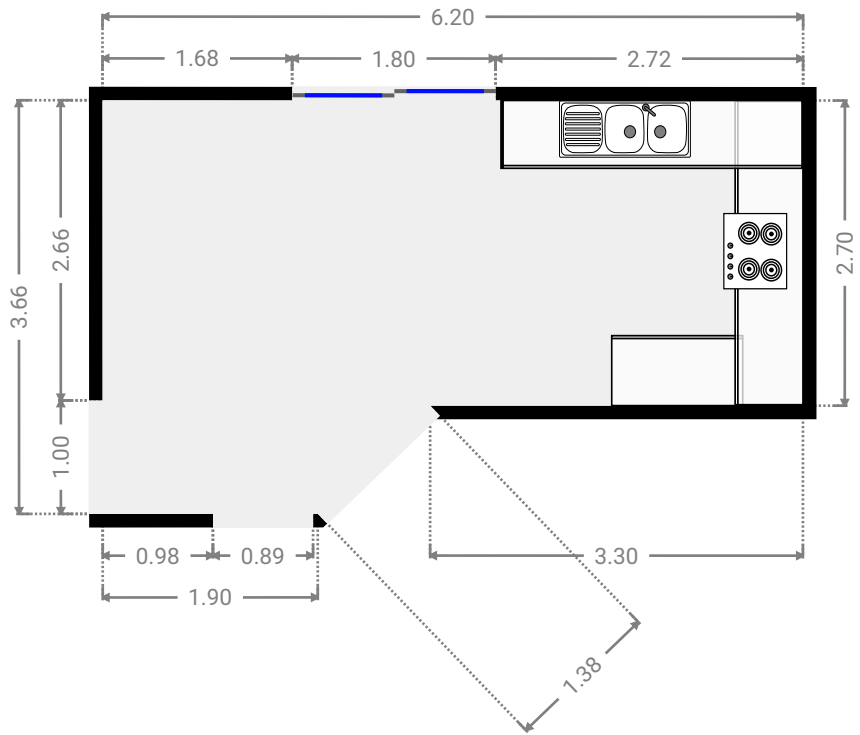
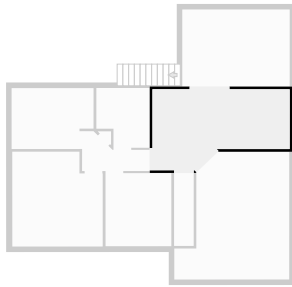

▼ Hall
1st Floor

WIDTH: 3.08 m • LENGTH: 1.80 m
AREA: 3.74 m² • PERIMETER: 9.26 m

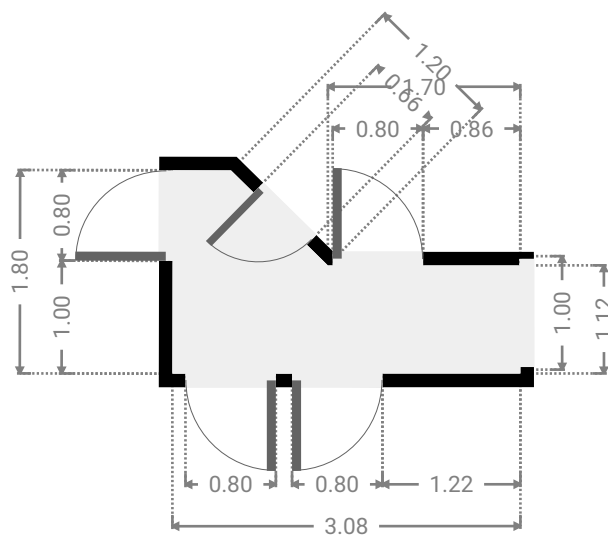
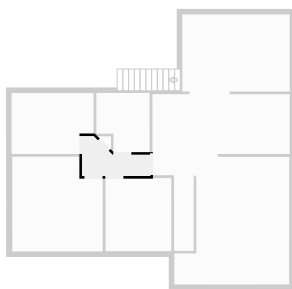

▼ Bathroom
1st Floor

WIDTH: 2.40 m • LENGTH: 2.70 m
AREA: 5.82 m² • PERIMETER: 10.20 m

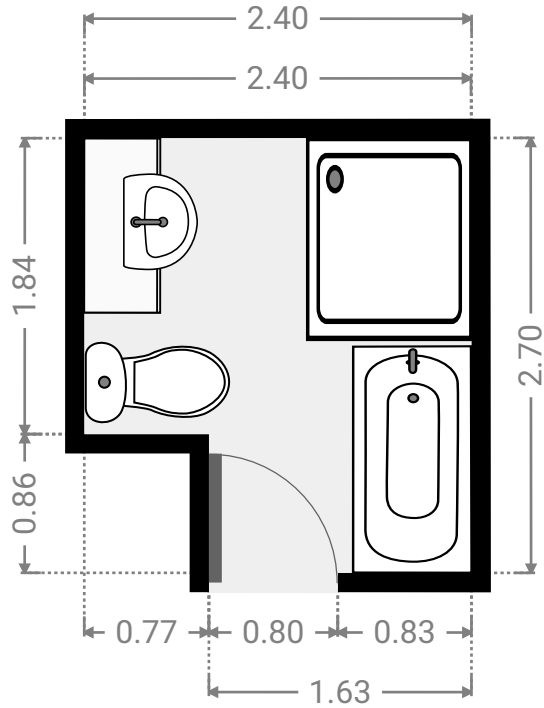
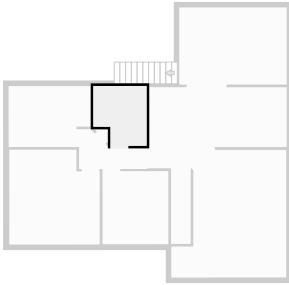

▼ Closet
1st Floor

WIDTH: 0.60 m • LENGTH: 0.62 m
AREA: 0.19 m² • PERIMETER: 2.09 m

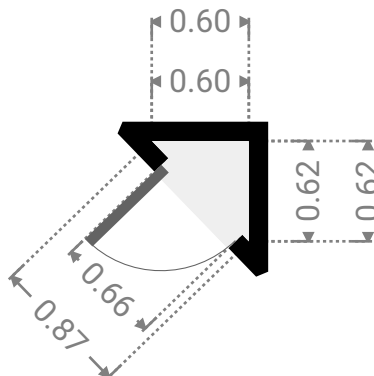
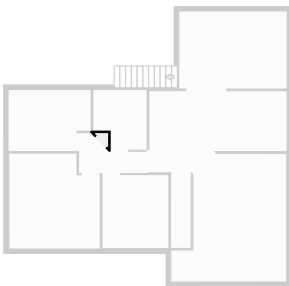

▼ **Bedroom**
1st Floor

WIDTH: 3.70 m • LENGTH: 2.75 m
AREA: 9.59 m² • PERIMETER: 12.90 m

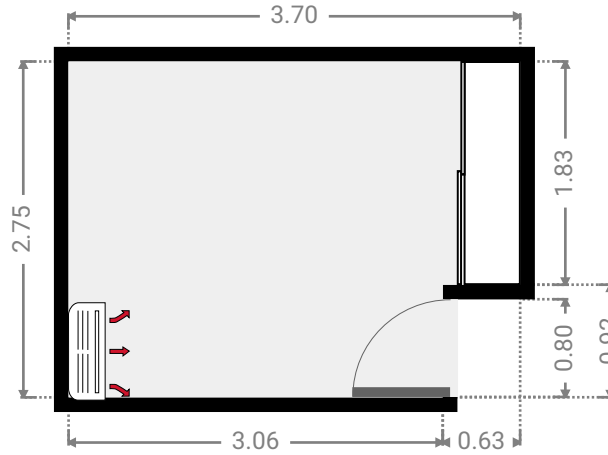
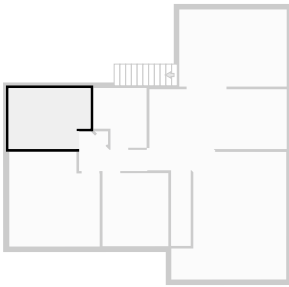

▼ **Master Bedroom**
1st Floor

WIDTH: 4.08 m • LENGTH: 4.28 m
AREA: 16.45 m² • PERIMETER: 16.73 m

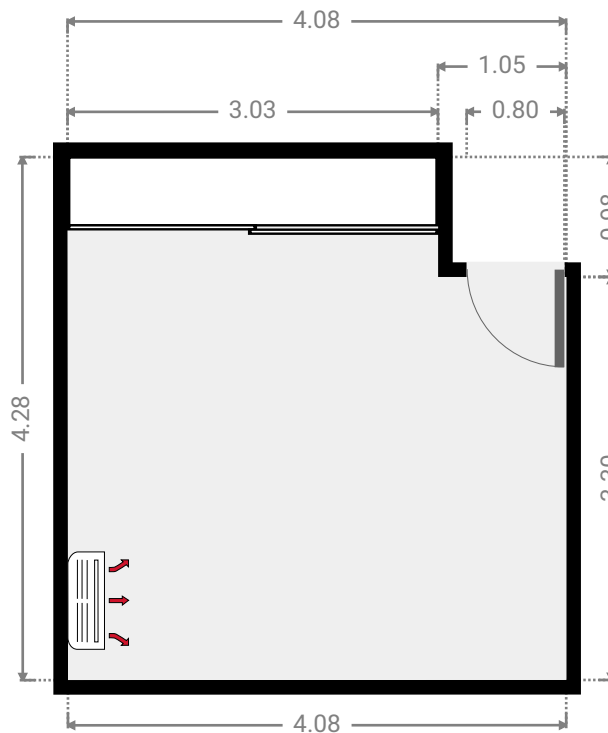
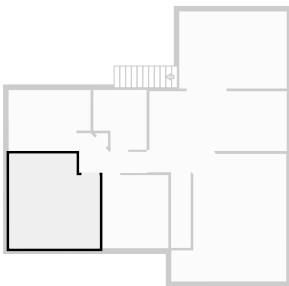

▼ Bedroom 1st Floor

WIDTH: 2.97 m • LENGTH: 3.30 m
AREA: 9.80 m² • PERIMETER: 12.54 m

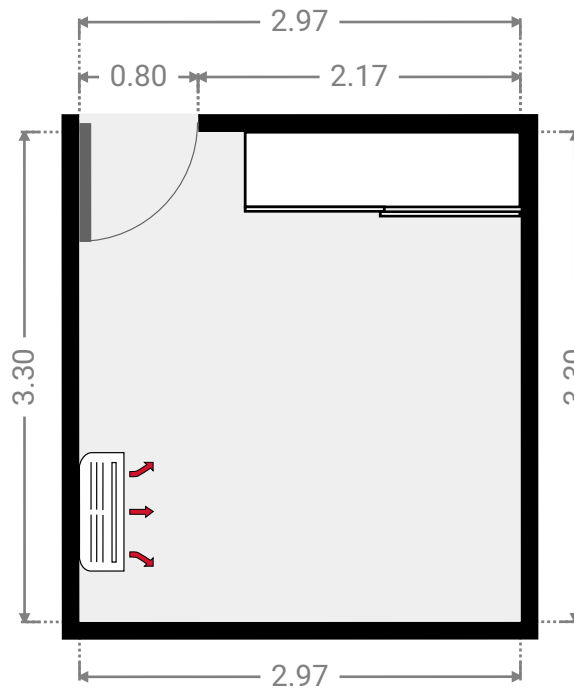
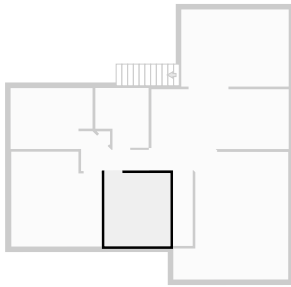

▼ Other 1st Floor

WIDTH: 4.85 m • LENGTH: 3.48 m
AREA: 16.88 m² • PERIMETER: 16.66 m

