

# 362 French Avenue

**SUBMITTED BY**  
Ray White Rockhampton Casey  
stockers@cqoz.com

---

**CREATED ON**  
2021-11-23

---

**Floors**  
2

---

▼ Ground Floor

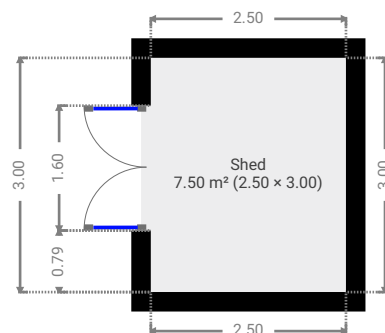
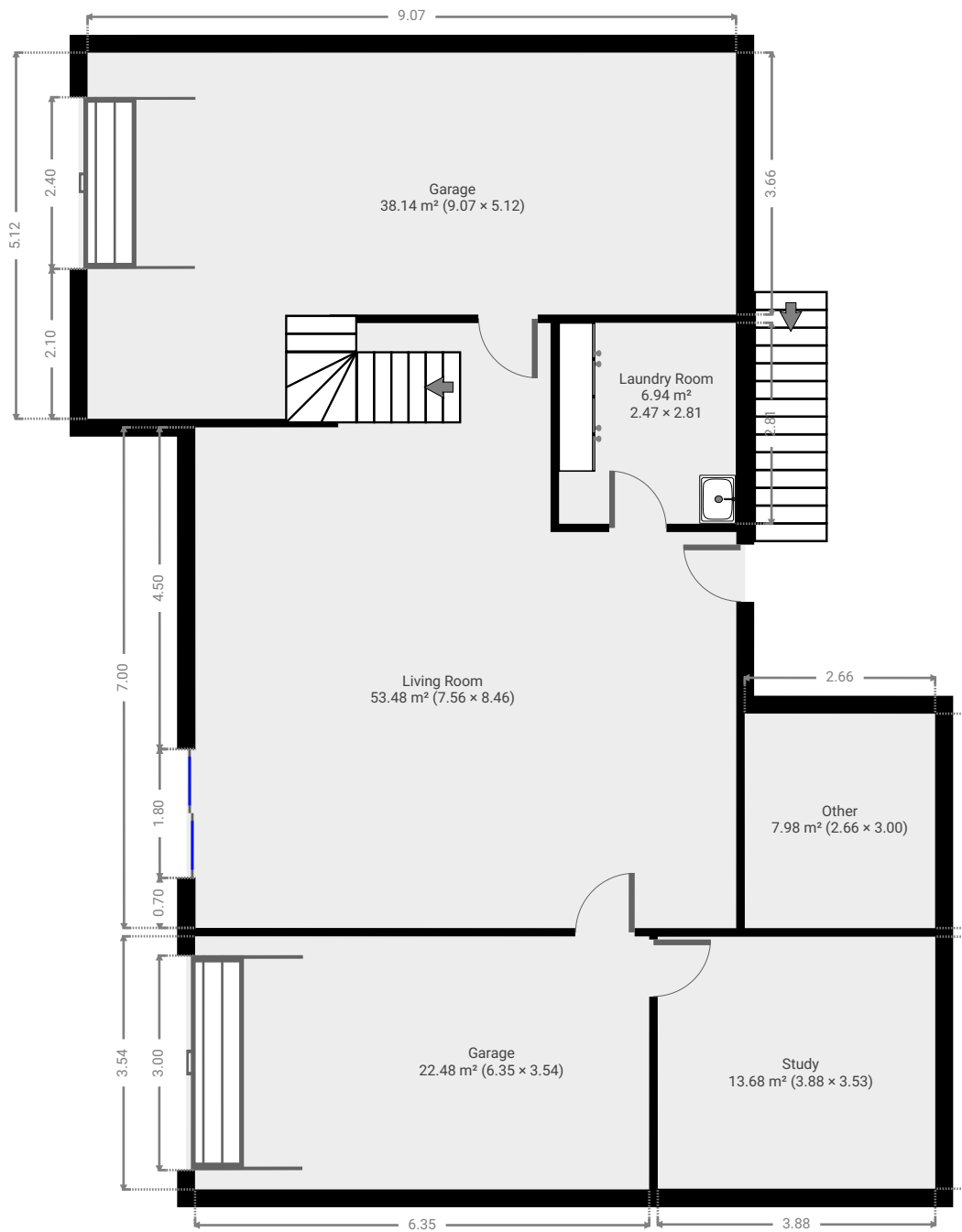

▼ **Garage**  
Ground Floor

WIDTH: 5.12 m • LENGTH: 9.05 m  
AREA: 38.14 m<sup>2</sup> • PERIMETER: 28.38 m

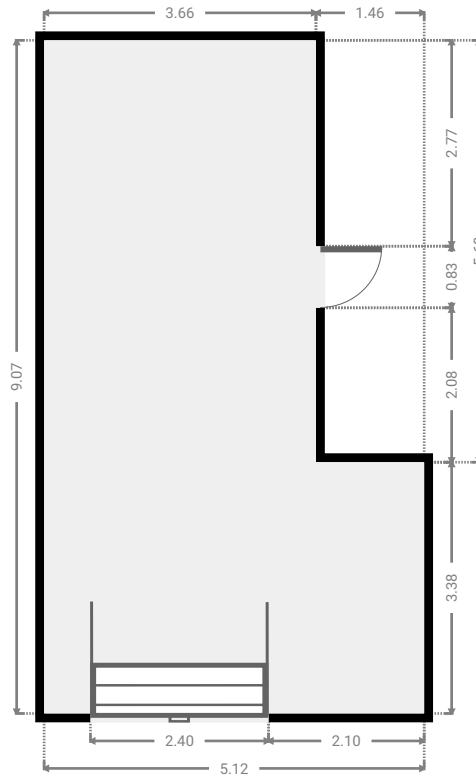
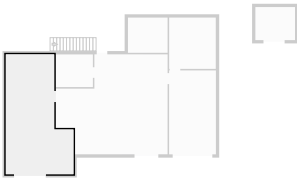

▼ **Living Room**  
Ground Floor

WIDTH: 8.46 m • LENGTH: 7.56 m  
AREA: 53.48 m<sup>2</sup> • PERIMETER: 32.04 m

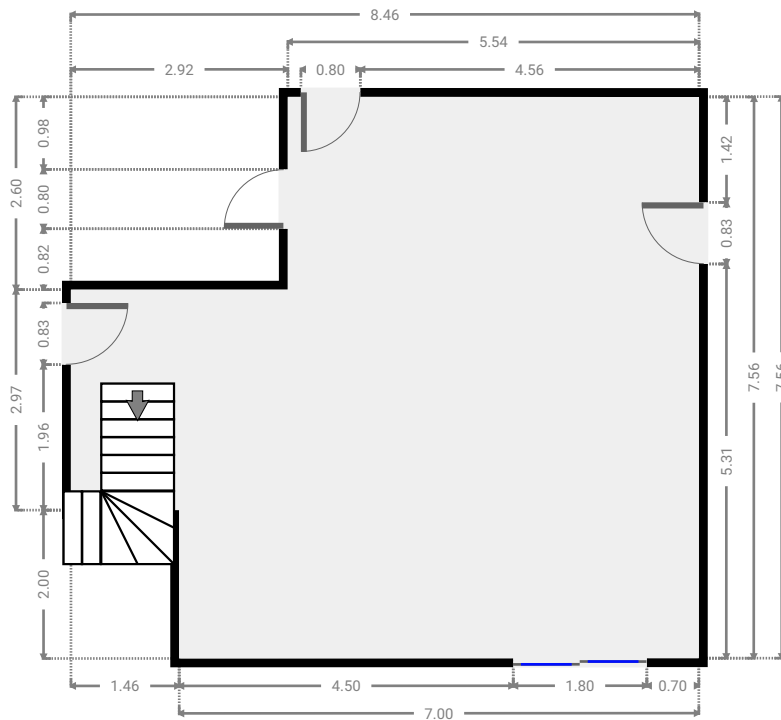
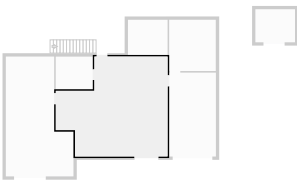

▼ **Laundry Room**  
Ground Floor

WIDTH: 2.81 m • LENGTH: 2.47 m  
AREA: 6.94 m<sup>2</sup> • PERIMETER: 10.56 m

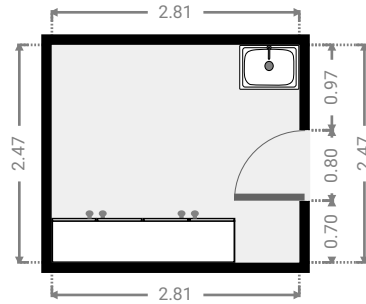
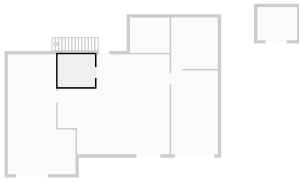

▼ **Garage**  
Ground Floor

WIDTH: 3.54 m • LENGTH: 6.35 m  
AREA: 22.48 m<sup>2</sup> • PERIMETER: 19.78 m

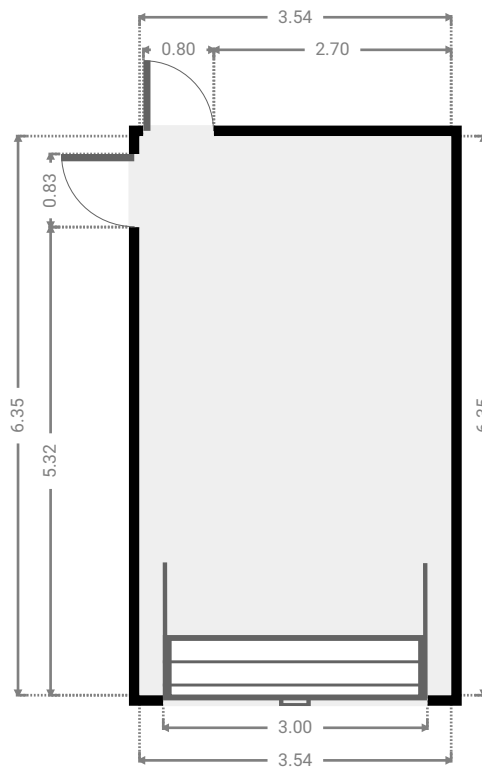
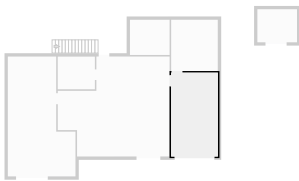

▼ **Study**  
Ground Floor

WIDTH: 3.53 m • LENGTH: 3.88 m  
AREA: 13.68 m<sup>2</sup> • PERIMETER: 14.81 m

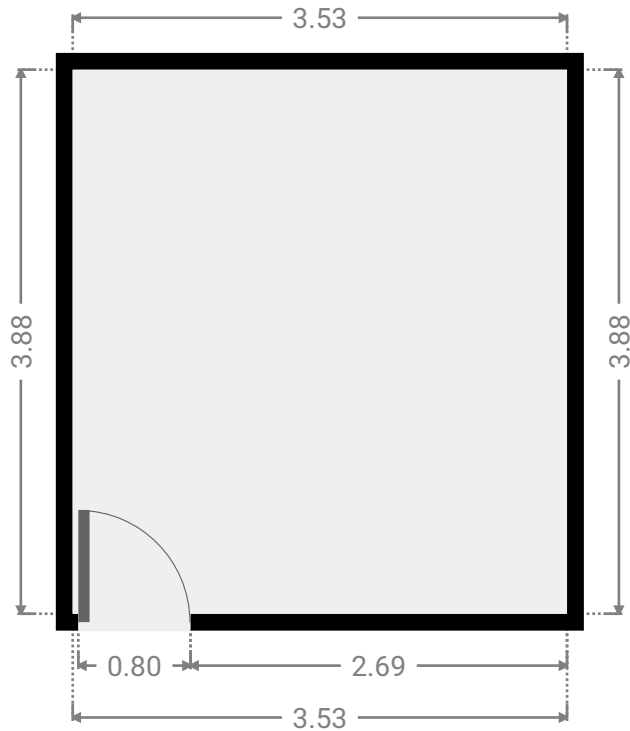
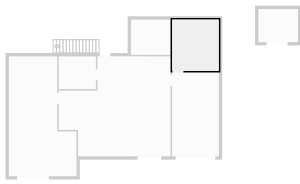

▼ **Other**  
Ground Floor

WIDTH: 3.00 m • LENGTH: 2.66 m  
AREA: 7.98 m<sup>2</sup> • PERIMETER: 11.32 m

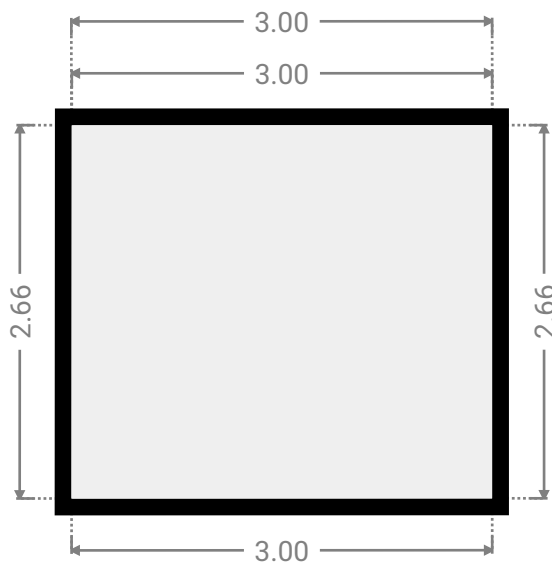
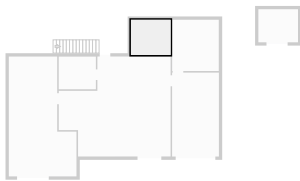

▼ **Shed**  
Ground Floor

WIDTH: 3.00 m • LENGTH: 2.50 m  
AREA: 7.50 m<sup>2</sup> • PERIMETER: 11.00 m

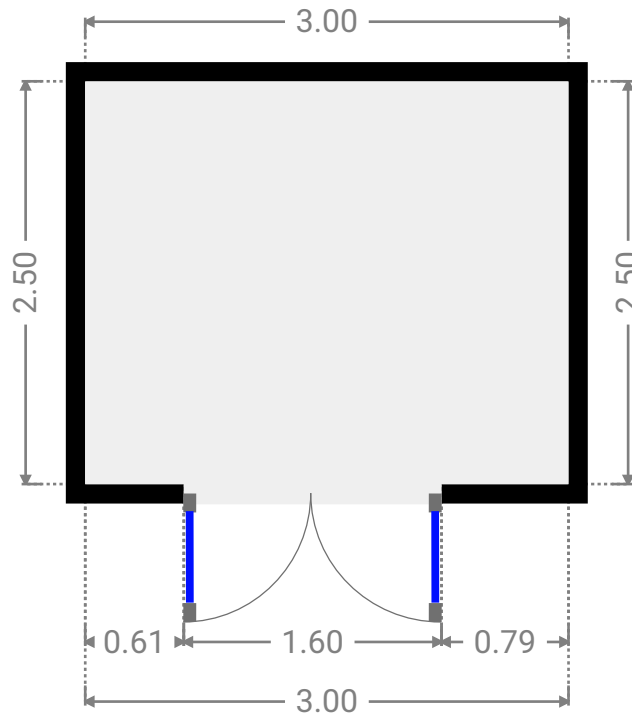
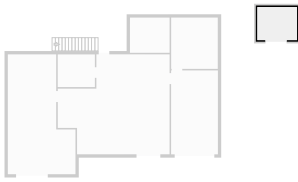

▼ 1st Floor

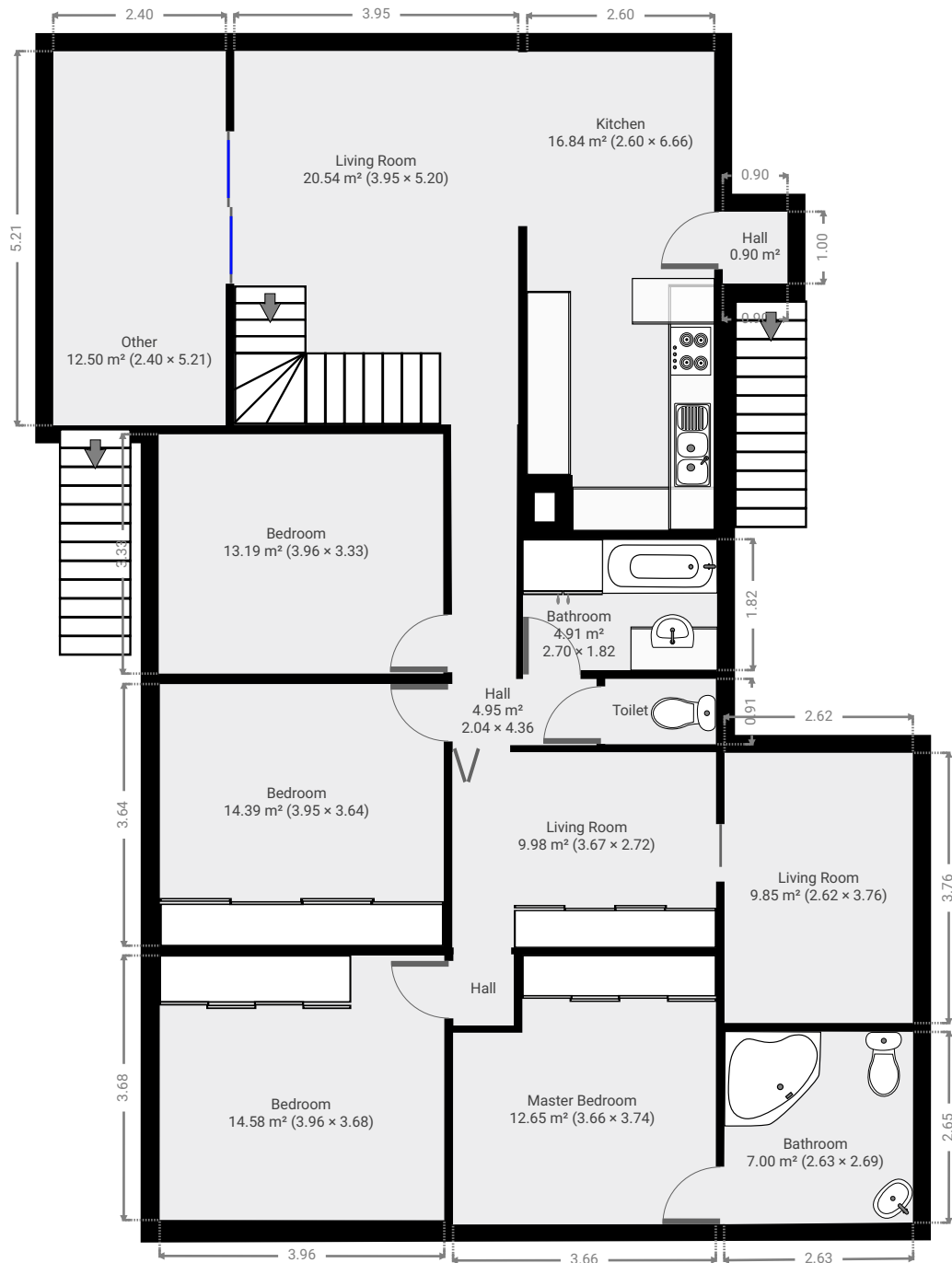

▼ Living Room  
1st Floor

WIDTH: 5.20 m • LENGTH: 3.95 m  
AREA: 20.54 m<sup>2</sup> • PERIMETER: 18.30 m

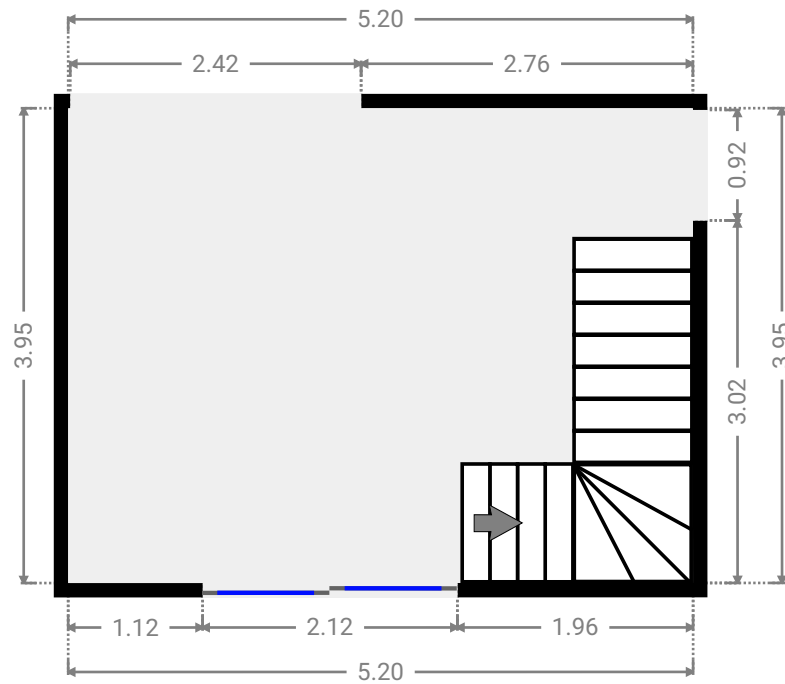
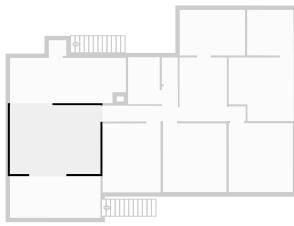

▼ Kitchen  
1st Floor

WIDTH: 6.66 m • LENGTH: 2.60 m  
AREA: 16.84 m<sup>2</sup> • PERIMETER: 18.52 m

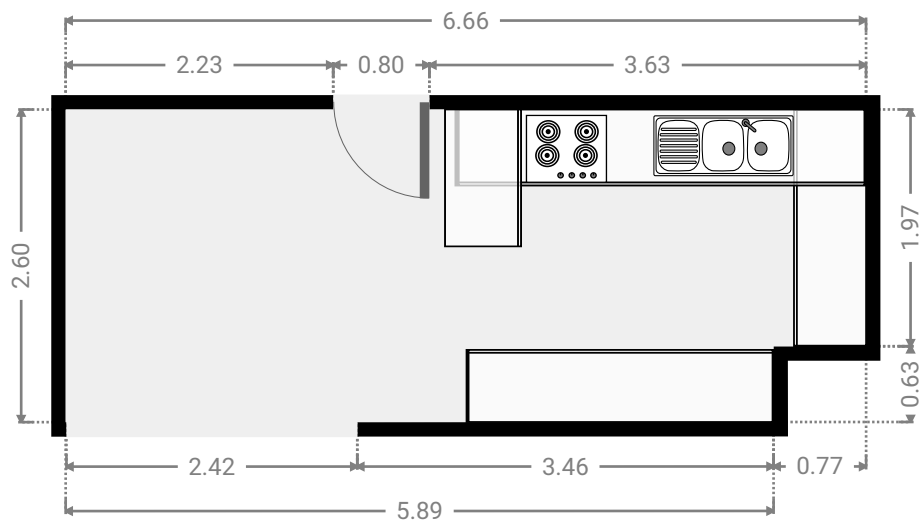
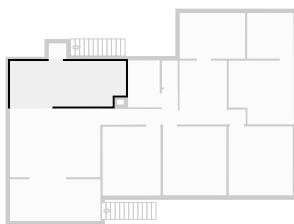



▼ **Hall**  
1st Floor

WIDTH: 4.36 m • LENGTH: 2.04 m  
AREA: 4.95 m<sup>2</sup> • PERIMETER: 12.76 m

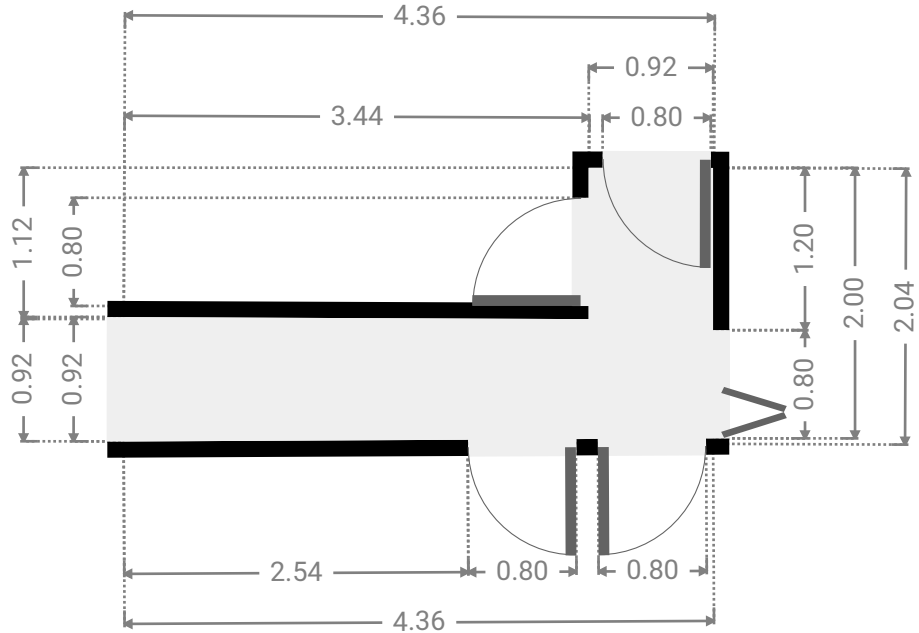
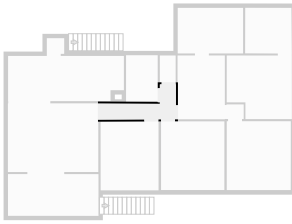

▼ **Bathroom**  
1st Floor

WIDTH: 1.82 m • LENGTH: 2.70 m  
AREA: 4.91 m<sup>2</sup> • PERIMETER: 9.04 m

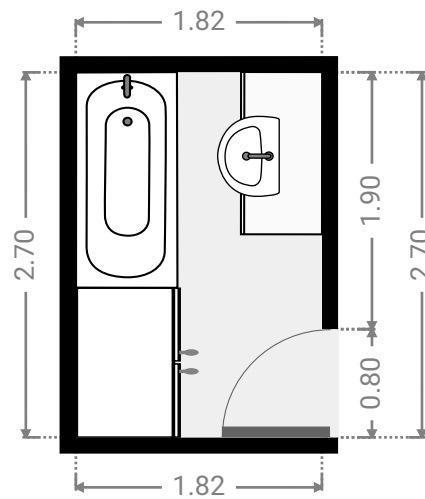
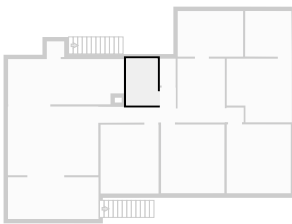

▼ **Toilet**  
1st Floor

WIDTH: 0.91 m • LENGTH: 1.54 m  
AREA: 1.40 m<sup>2</sup> • PERIMETER: 4.90 m

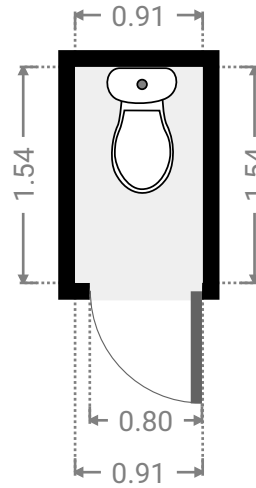
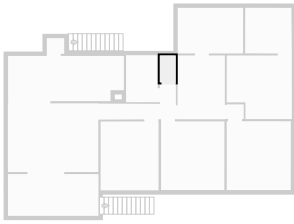

▼ **Bedroom**  
1st Floor

WIDTH: 3.33 m • LENGTH: 3.96 m  
AREA: 13.19 m<sup>2</sup> • PERIMETER: 14.58 m

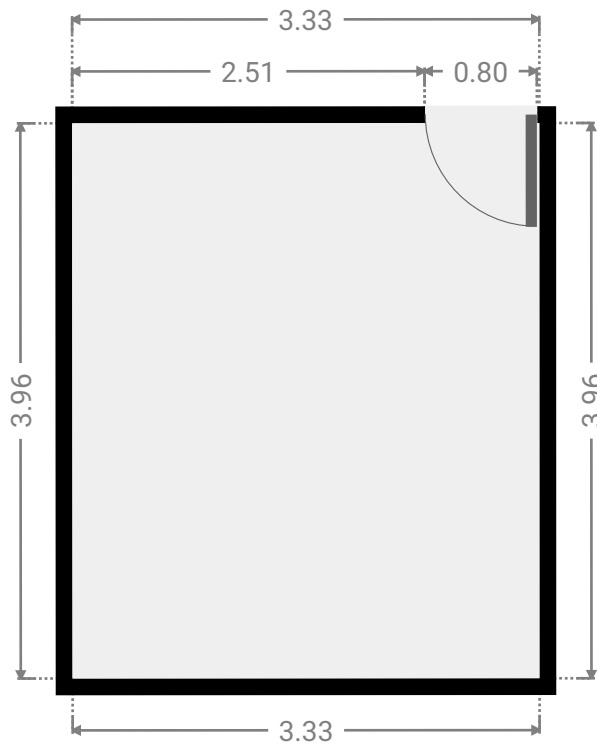
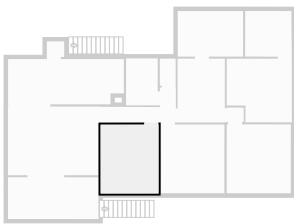

▼ **Bedroom**  
1st Floor

WIDTH: 3.64 m • LENGTH: 3.95 m  
AREA: 14.39 m<sup>2</sup> • PERIMETER: 15.18 m

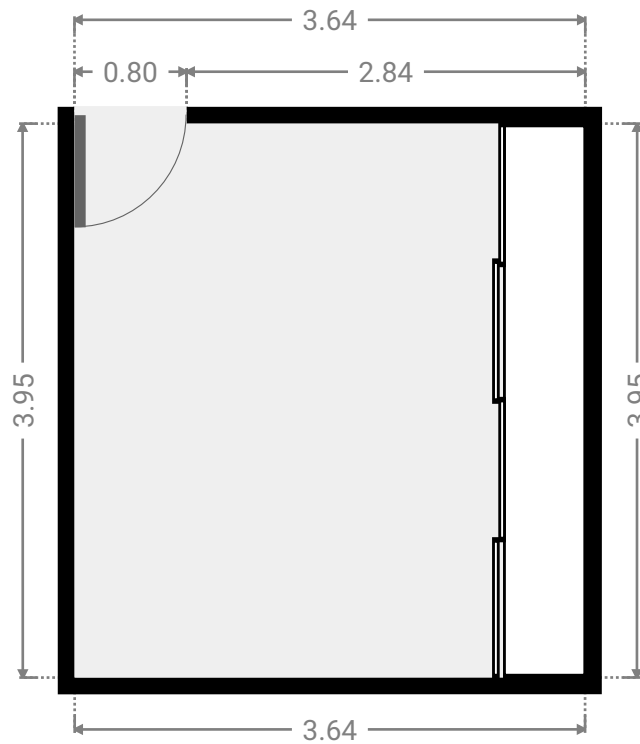
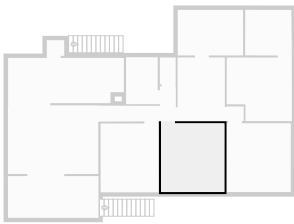

▼ **Living Room**  
1st Floor

WIDTH: 2.72 m • LENGTH: 3.67 m  
AREA: 9.98 m<sup>2</sup> • PERIMETER: 12.78 m

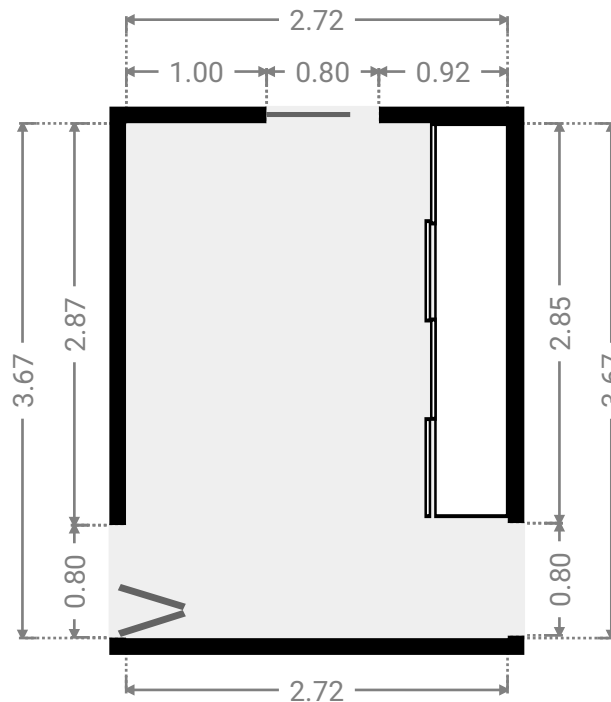
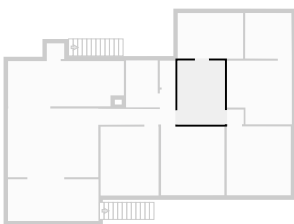

▼ **Living Room**  
1st Floor

WIDTH: 3.76 m • LENGTH: 2.62 m  
AREA: 9.85 m<sup>2</sup> • PERIMETER: 12.76 m

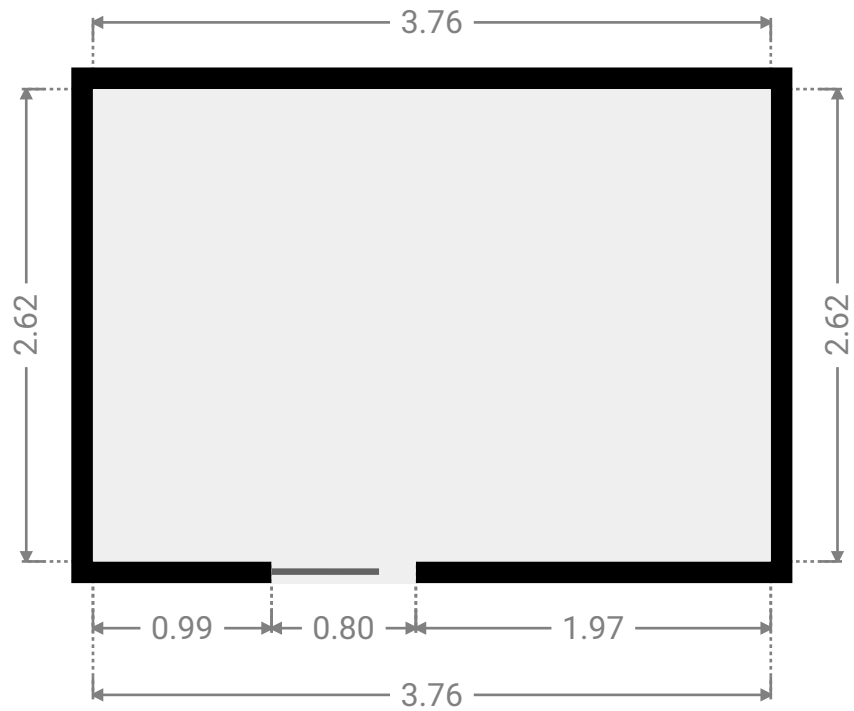
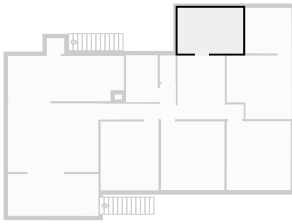

▼ **Hall**  
1st Floor

WIDTH: 0.99 m • LENGTH: 0.84 m  
AREA: 0.83 m<sup>2</sup> • PERIMETER: 3.66 m

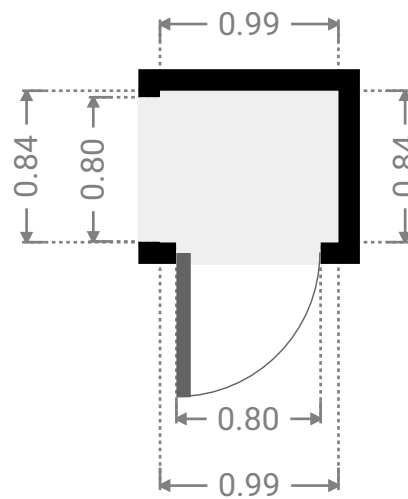
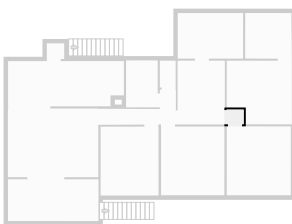

▼ **Bedroom**  
1st Floor

WIDTH: 3.68 m • LENGTH: 3.96 m  
AREA: 14.58 m<sup>2</sup> • PERIMETER: 15.28 m

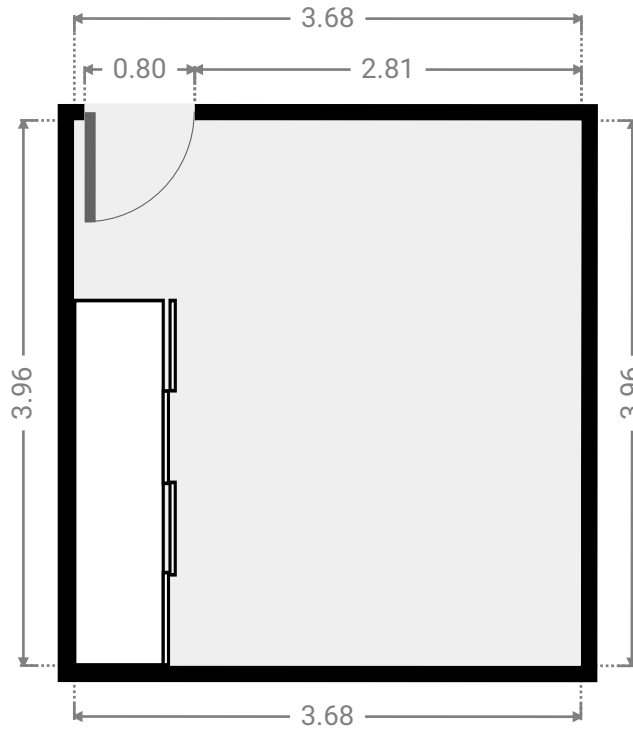
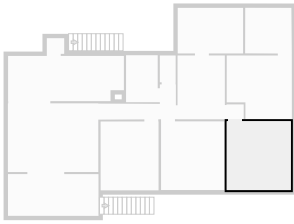

▼ **Master Bedroom**  
1st Floor

WIDTH: 3.74 m • LENGTH: 3.66 m  
AREA: 12.65 m<sup>2</sup> • PERIMETER: 14.80 m

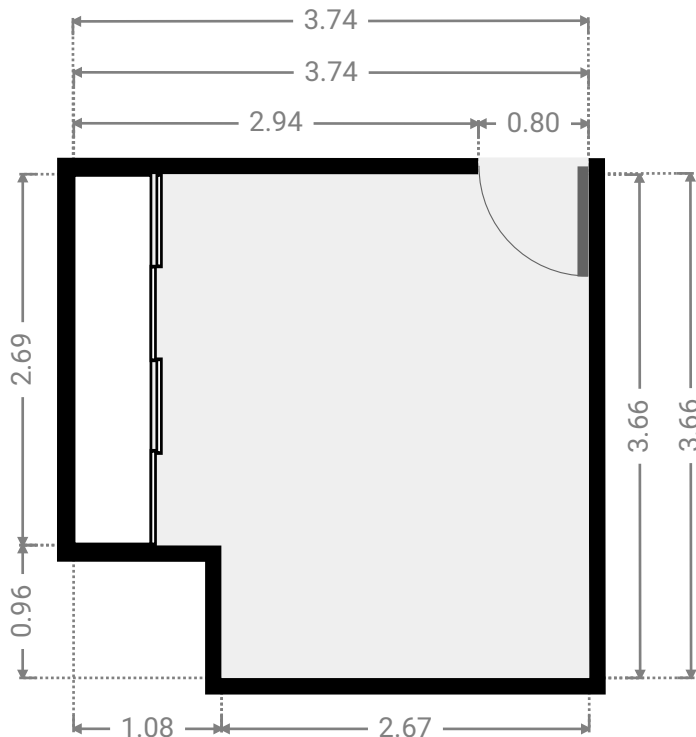
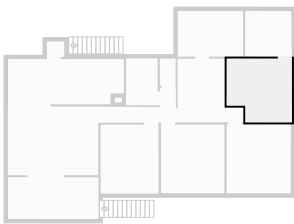

▼ **Bathroom**  
1st Floor

WIDTH: 2.69 m • LENGTH: 2.63 m  
AREA: 7.00 m<sup>2</sup> • PERIMETER: 10.58 m

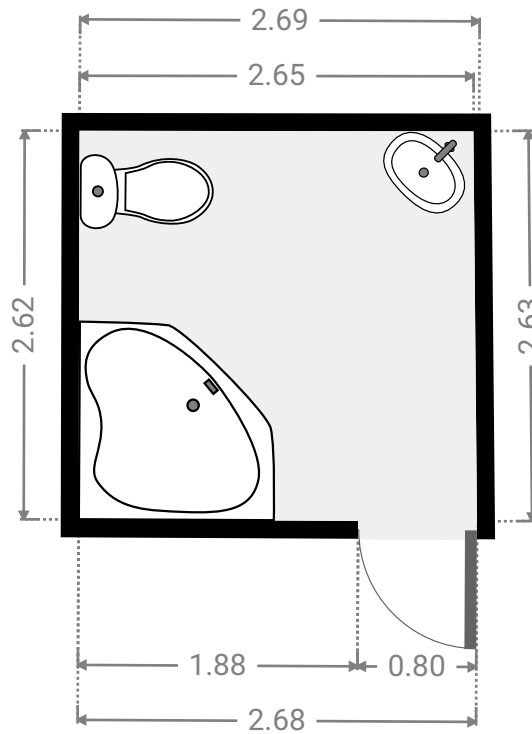
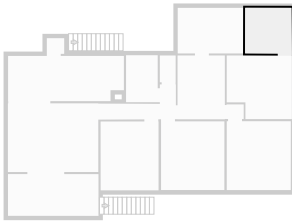

▼ **Other**  
1st Floor

WIDTH: 5.21 m • LENGTH: 2.40 m  
AREA: 12.50 m<sup>2</sup> • PERIMETER: 15.21 m

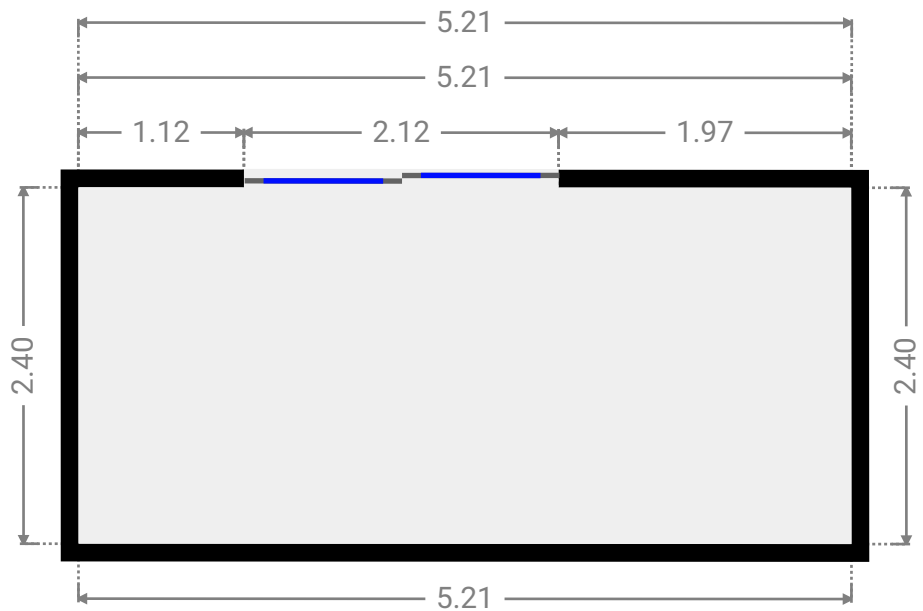
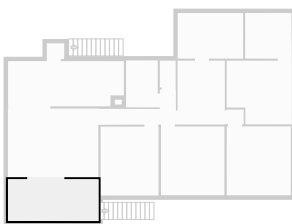

▼ **Hall**  
1st Floor

WIDTH: 1.00 m • LENGTH: 0.90 m  
AREA: 0.90 m<sup>2</sup> • PERIMETER: 3.80 m

