

39 River Rose Drive

SUBMITTED BY
Ray White Rockhampton Casey
stockers@cqoz.com

CREATED ON
2022-05-11

Floors
1

▼ Ground Floor

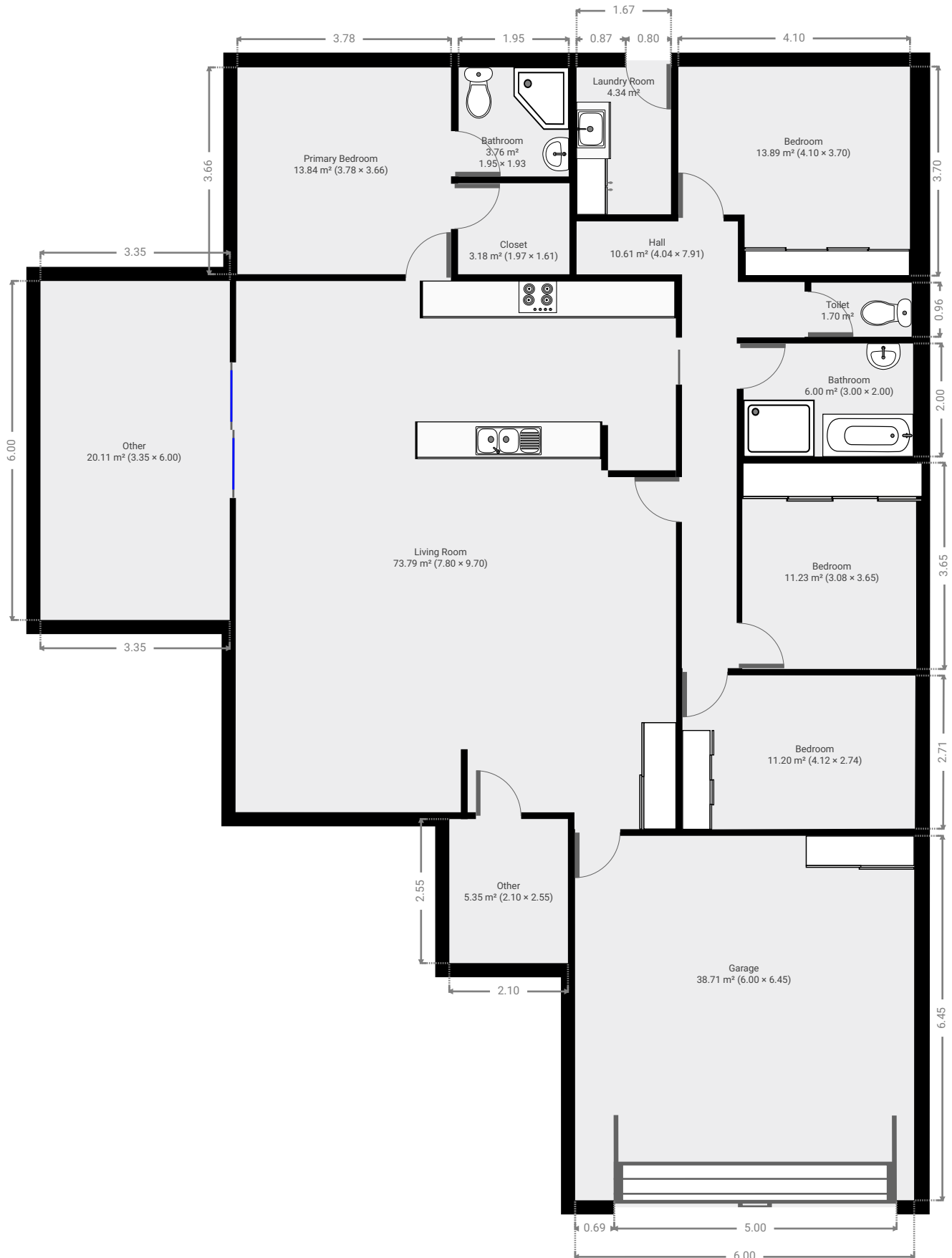

FLOORS: 1

▼ **Bathroom**
Ground Floor

WIDTH: 1.95 m • LENGTH: 1.93 m
AREA: 3.76 m² • PERIMETER: 7.76 m

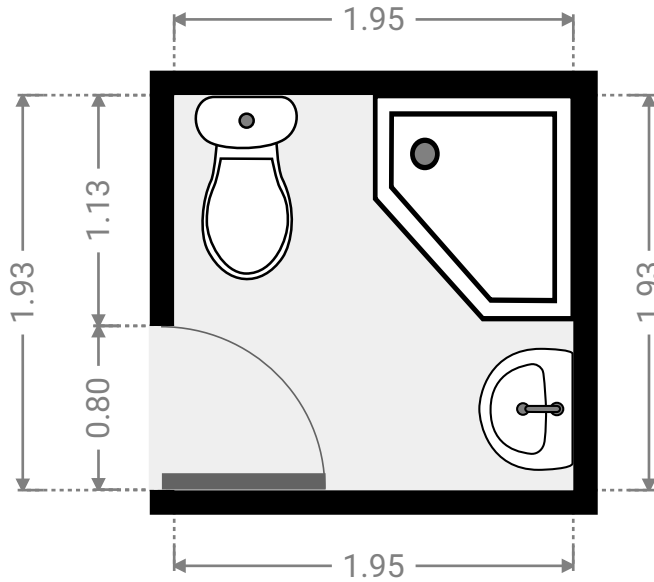
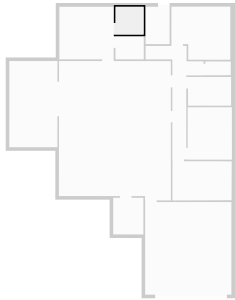

▼ **Bathroom**
Ground Floor

WIDTH: 3.00 m • LENGTH: 2.00 m
AREA: 6.00 m² • PERIMETER: 10.00 m

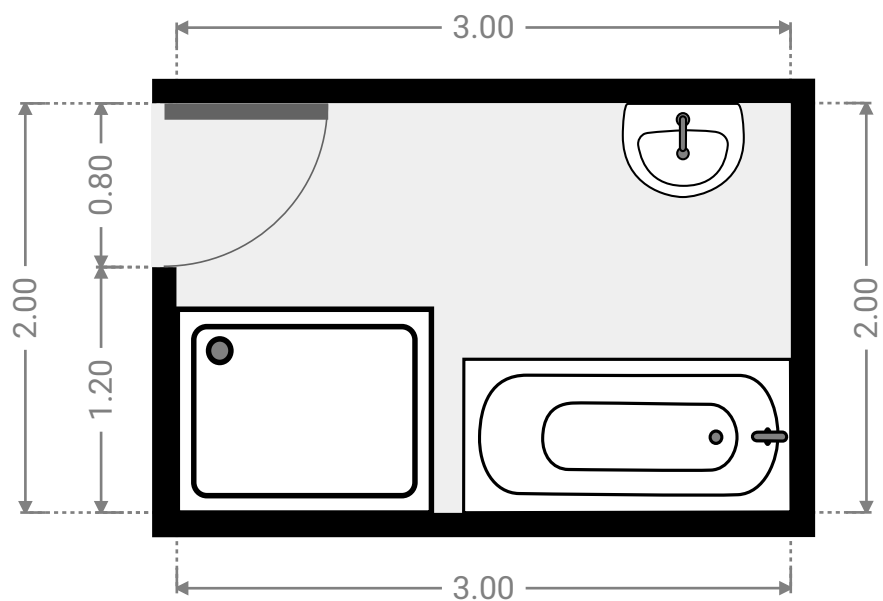
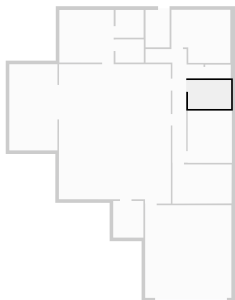

FLOORS: 1

▼ **Bedroom**
Ground Floor

WIDTH: 4.10 m • LENGTH: 3.70 m
AREA: 13.89 m² • PERIMETER: 15.60 m

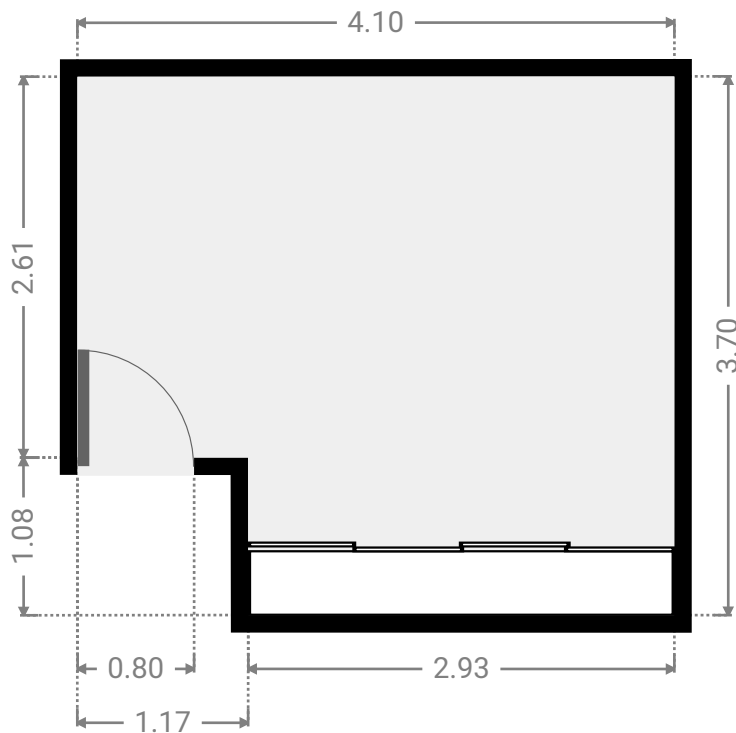
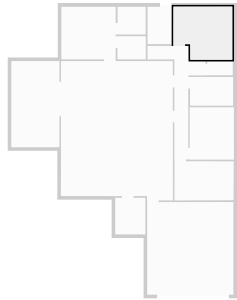

▼ **Bedroom**
Ground Floor

WIDTH: 3.08 m • LENGTH: 3.65 m
AREA: 11.23 m² • PERIMETER: 13.45 m

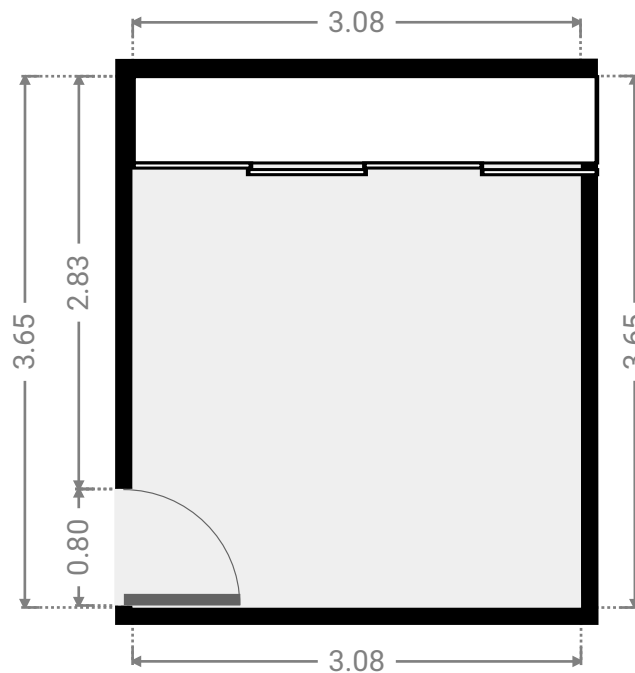
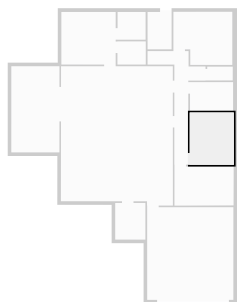

FLOORS: 1

▼ Bedroom Ground Floor

WIDTH: 4.12 m • LENGTH: 2.74 m
AREA: 11.20 m² • PERIMETER: 13.68 m

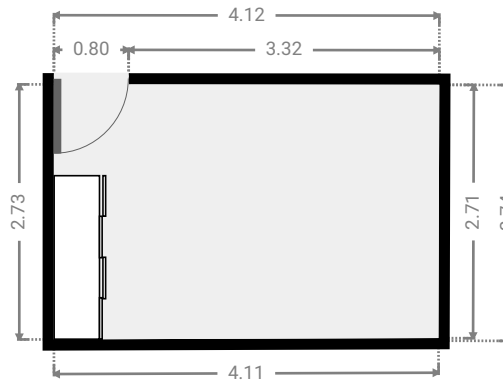
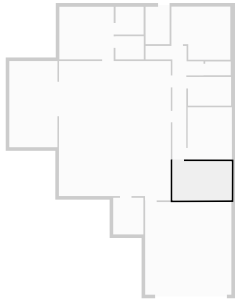

▼ Garage Ground Floor

WIDTH: 6.00 m • LENGTH: 6.45 m
AREA: 38.71 m² • PERIMETER: 24.90 m

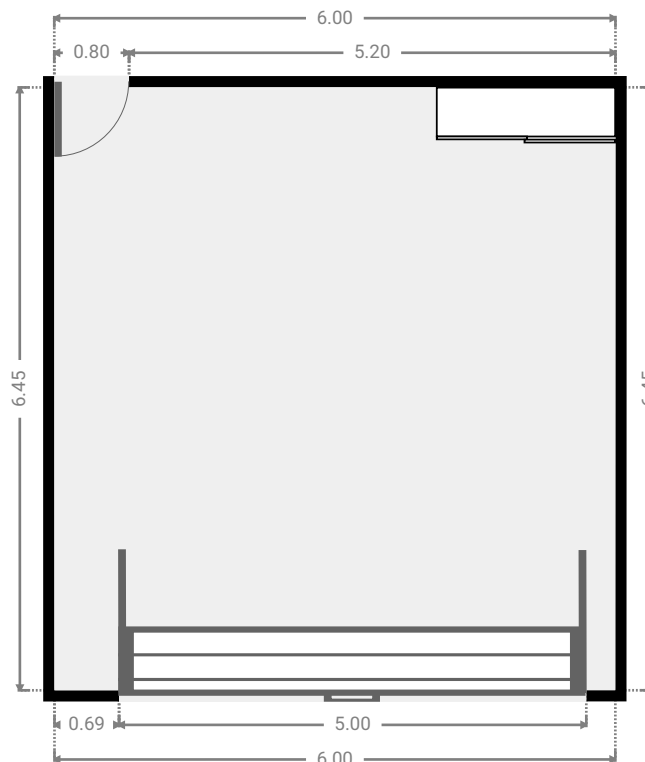
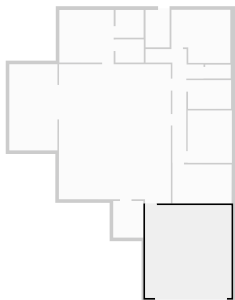

FLOORS: 1

▼ Hall Ground Floor

WIDTH: 4.04 m • LENGTH: 7.91 m
AREA: 10.61 m² • PERIMETER: 23.89 m

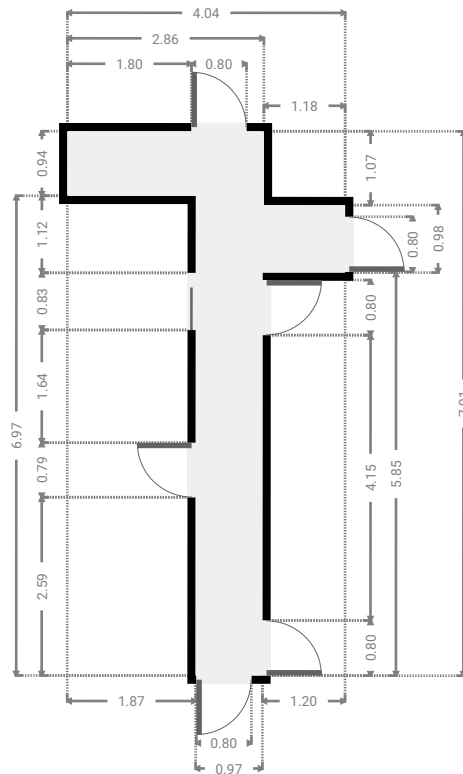
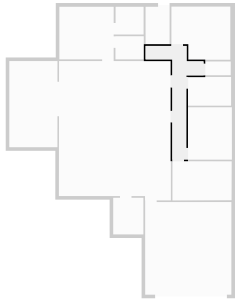

▼ Laundry Room Ground Floor

WIDTH: 1.67 m • LENGTH: 2.60 m
AREA: 4.34 m² • PERIMETER: 8.54 m

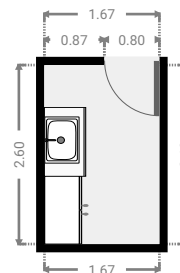
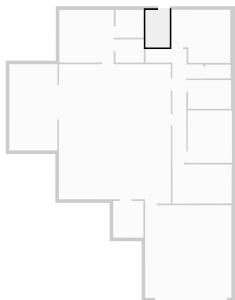

FLOORS: 1

▼ Living Room Ground Floor

WIDTH: 7.80 m • LENGTH: 9.70 m
AREA: 73.79 m² • PERIMETER: 34.98 m

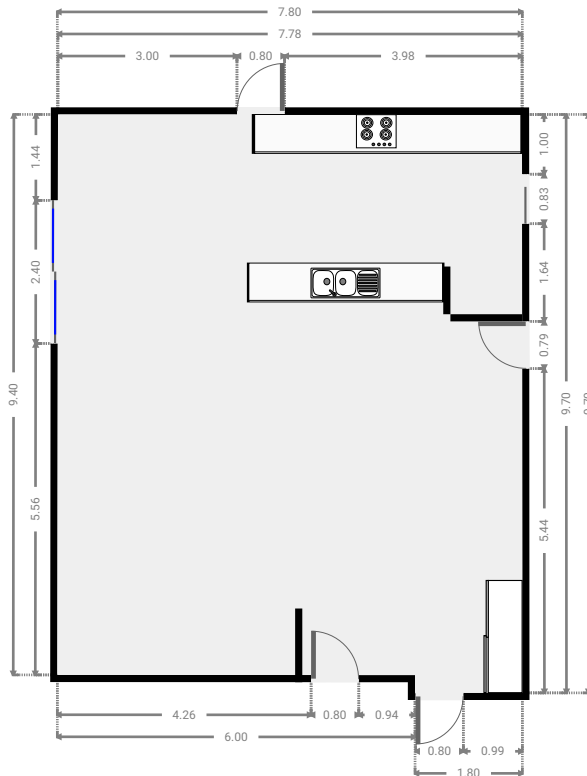
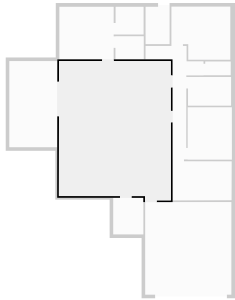

▼ Other Ground Floor

WIDTH: 3.35 m • LENGTH: 6.00 m
AREA: 20.11 m² • PERIMETER: 18.70 m

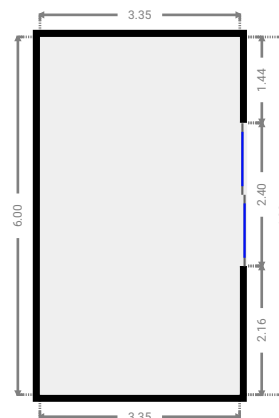
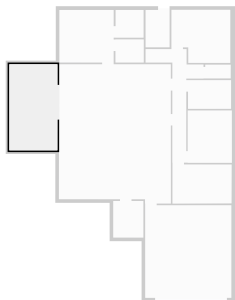

FLOORS: 1

▼ **Other**
Ground Floor

WIDTH: 2.10 m • LENGTH: 2.55 m
AREA: 5.35 m² • PERIMETER: 9.30 m

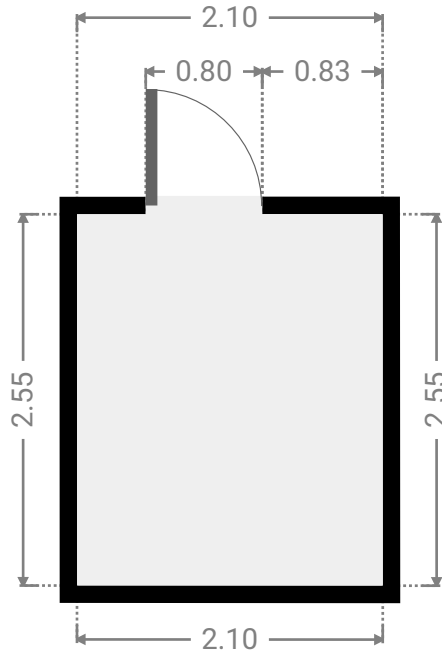
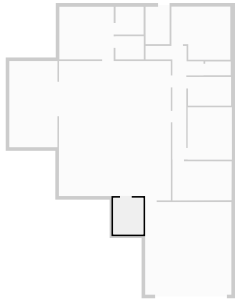

▼ **Primary Bedroom**
Ground Floor

WIDTH: 3.78 m • LENGTH: 3.66 m
AREA: 13.84 m² • PERIMETER: 14.88 m

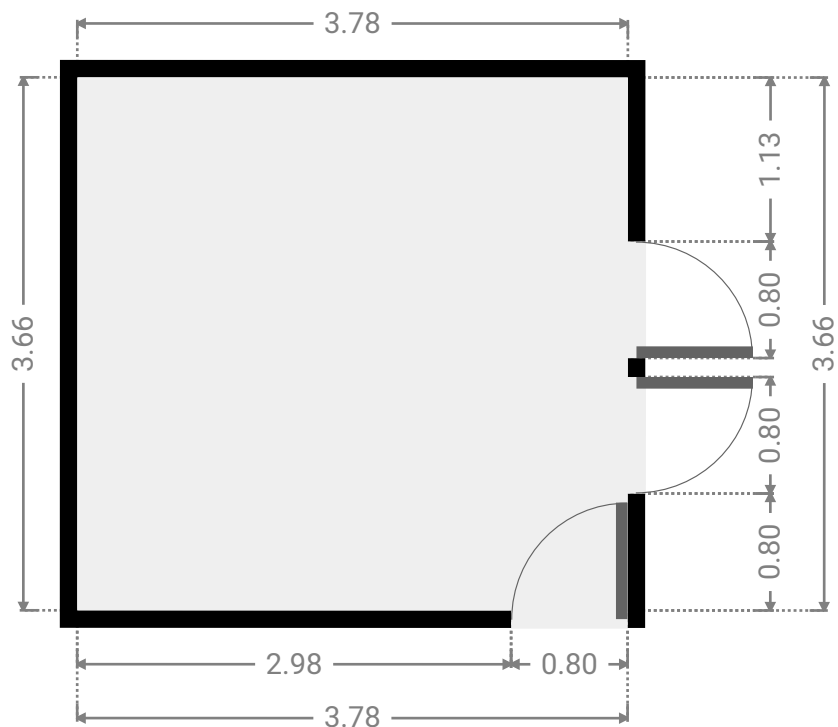
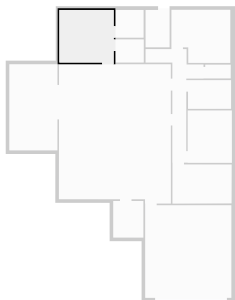

FLOORS: 1

▼ **Closet**
Ground Floor

WIDTH: 1.97 m • LENGTH: 1.61 m
AREA: 3.18 m² • PERIMETER: 7.17 m

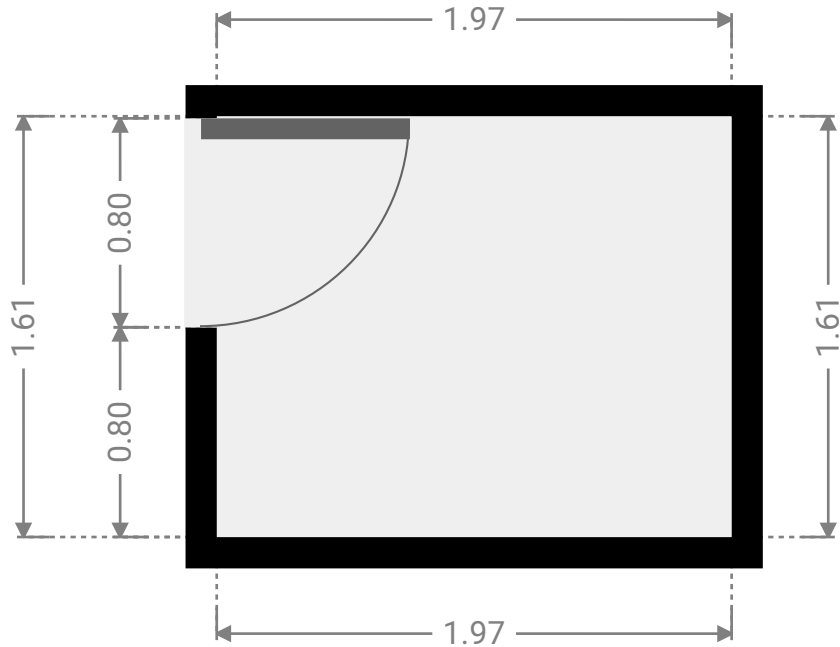
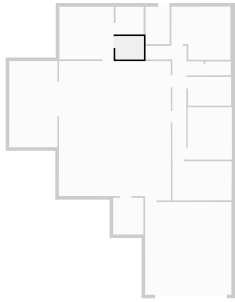

▼ **Toilet**
Ground Floor

WIDTH: 1.78 m • LENGTH: 0.96 m
AREA: 1.70 m² • PERIMETER: 5.47 m

