

39 Nagle Drive

Ground Floor



THIS FLOORPLAN IS PROVIDED WITHOUT WARRANTY OF ANY KIND. SENSOPIA DISCLAIMS ANY WARRANTY INCLUDING, WITHOUT LIMITATION, SATISFACTORY QUALITY OR ACCURACY OF DIMENSIONS.



39 Nagle Drive

Entry

Width: 2.14 m
 Length: 3.36 m
 Area: 7.19 m²
 Perimeter: 11.00 m

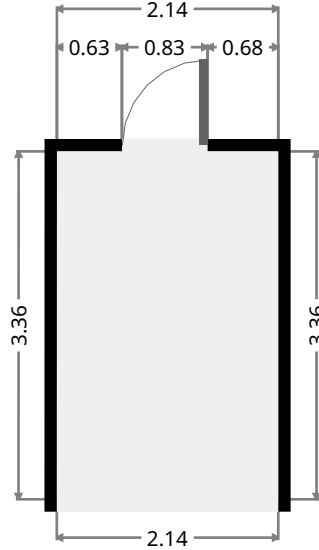
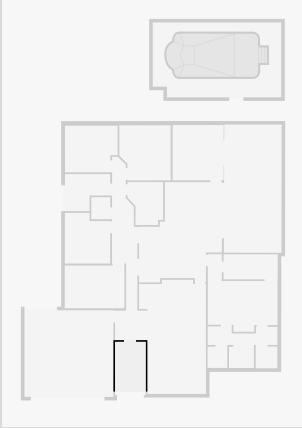

Garage

Width: 6.07 m
 Length: 6.23 m
 Area: 37.77 m²
 Perimeter: 24.58 m

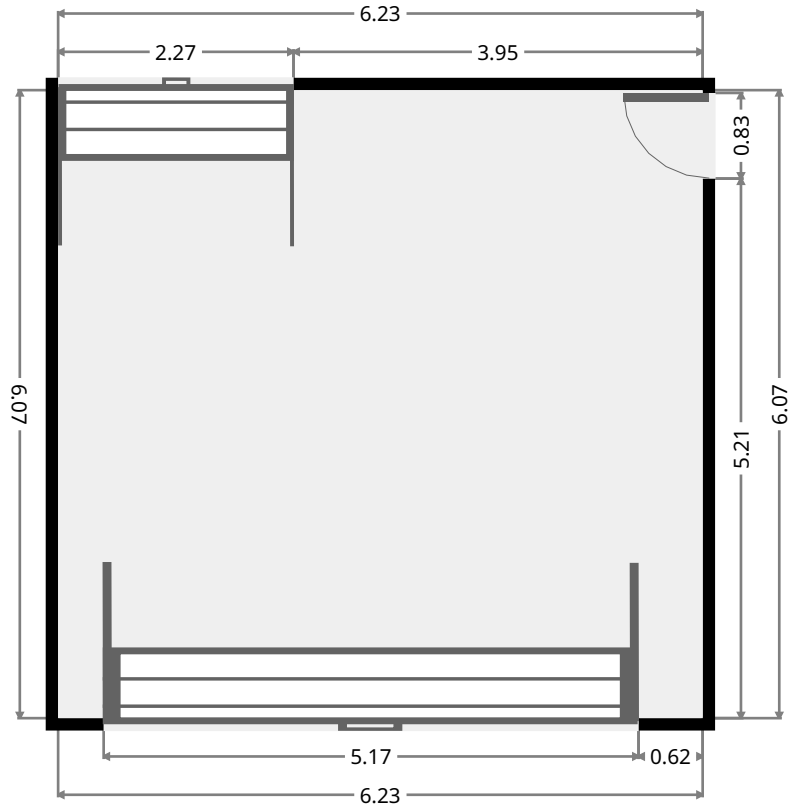
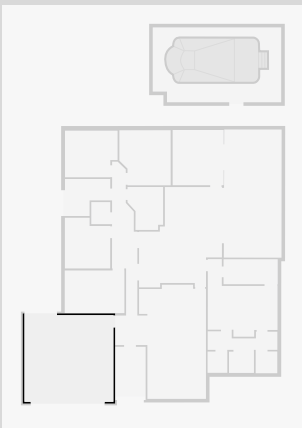

THIS FLOORPLAN IS PROVIDED WITHOUT WARRANTY OF ANY KIND. SENSOPIA DISCLAIMS ANY WARRANTY INCLUDING, WITHOUT LIMITATION, SATISFACTORY QUALITY OR ACCURACY OF DIMENSIONS.

39 Nagle Drive

Outdoor Area

Width: 4.04 m
 Length: 8.98 m
 Area: 36.14 m²
 Perimeter: 26.00 m

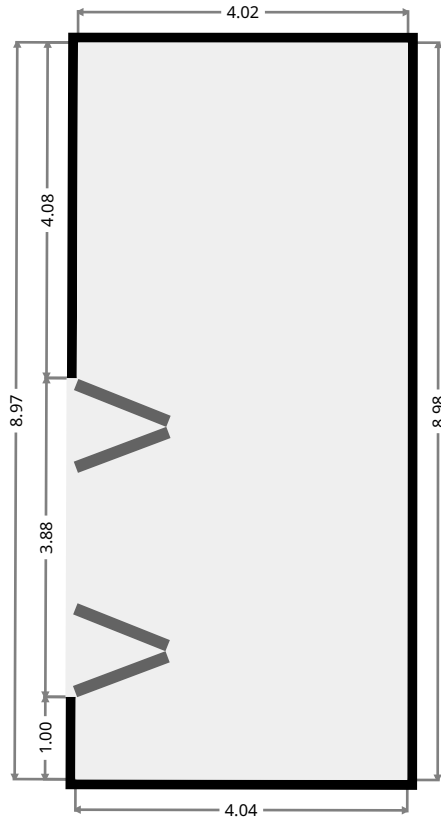
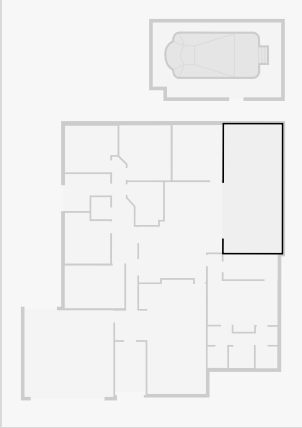

Bathroom

Width: 2.49 m
 Length: 3.01 m
 Area: 6.46 m²
 Perimeter: 10.67 m

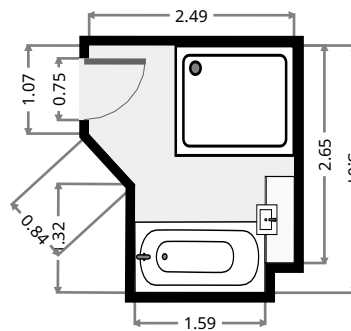
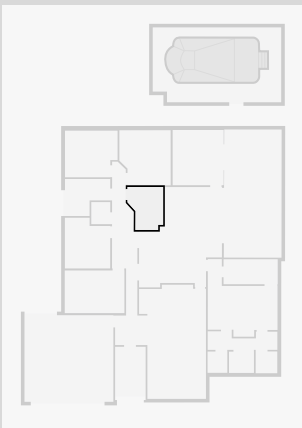

39 Nagle Drive

Bedroom

Width: 3.58 m
 Length: 3.86 m
 Area: 13.02 m²
 Perimeter: 14.56 m

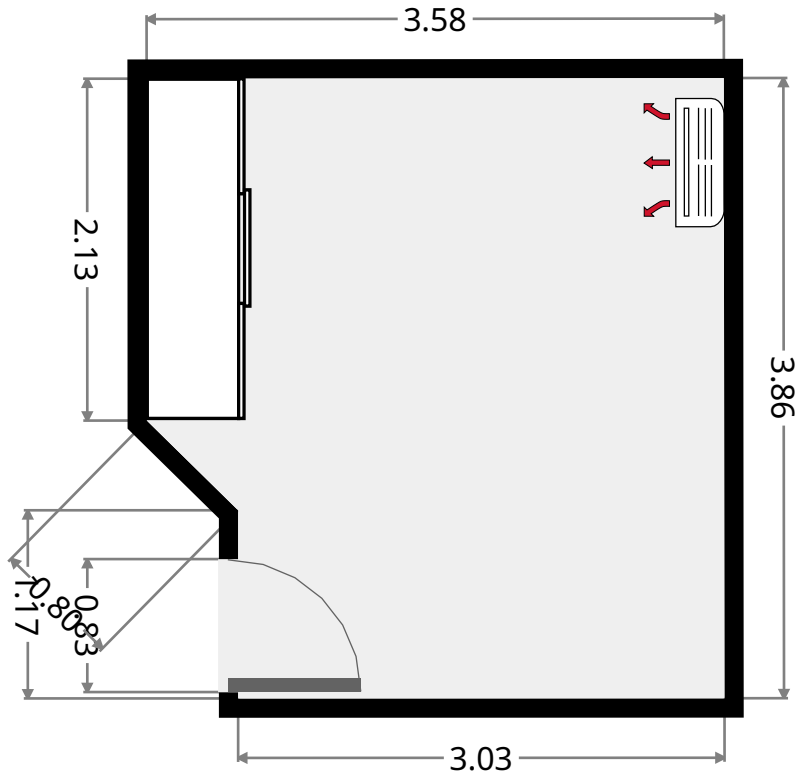
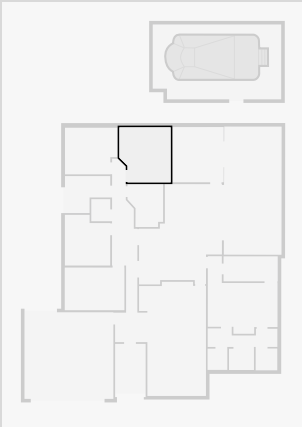

Bedroom

Width: 3.26 m
 Length: 3.69 m
 Area: 11.40 m²
 Perimeter: 13.89 m

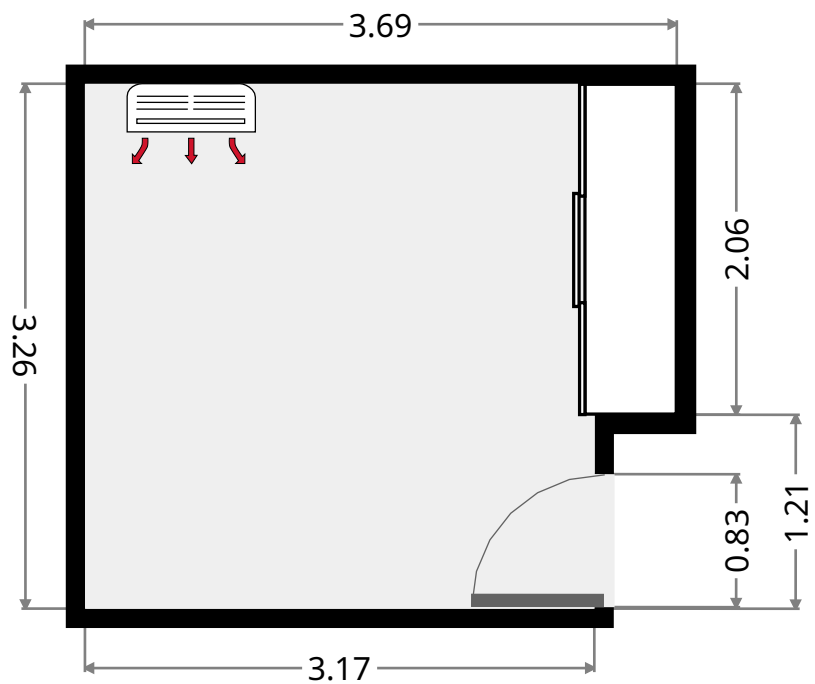
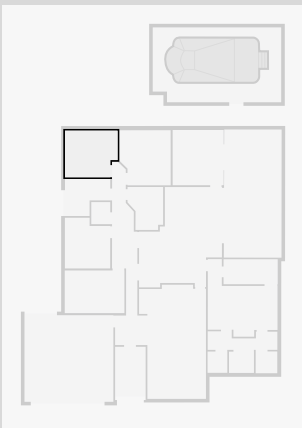

THIS FLOORPLAN IS PROVIDED WITHOUT WARRANTY OF ANY KIND. SENSOPIA DISCLAIMS ANY WARRANTY INCLUDING, WITHOUT LIMITATION, SATISFACTORY QUALITY OR ACCURACY OF DIMENSIONS.

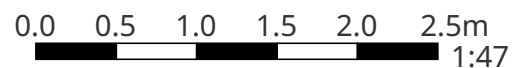

39 Nagle Drive

Laundry Room

Width: 2.59 m
 Length: 3.17 m
 Area: 6.62 m²
 Perimeter: 11.52 m

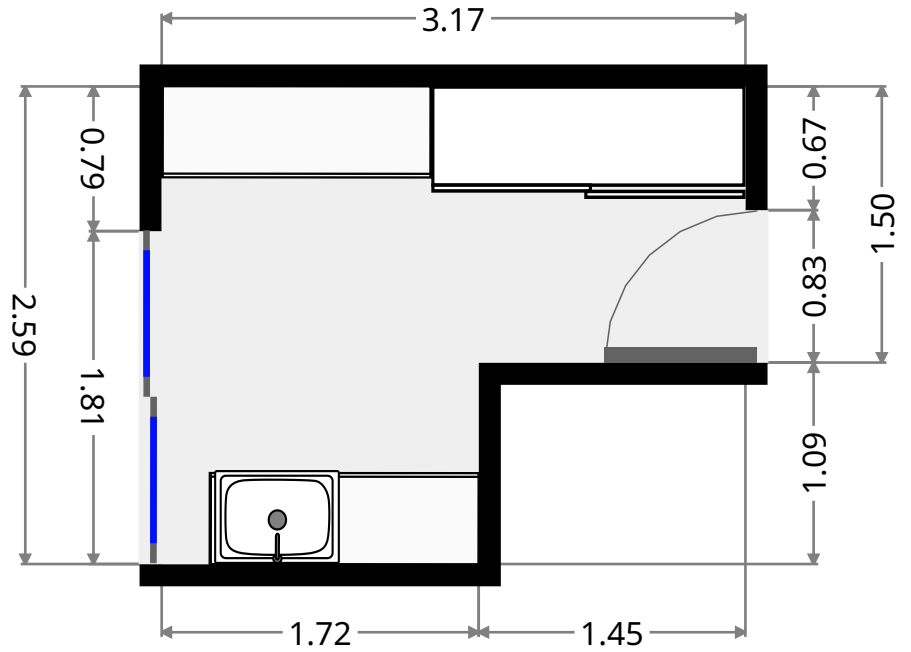
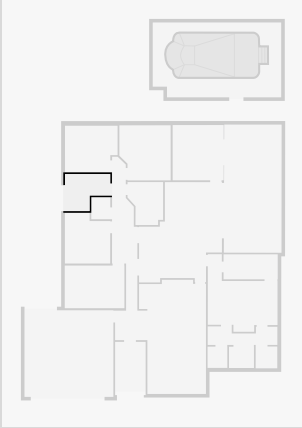

Toilet

Width: 1.33 m
 Length: 1.54 m
 Area: 2.05 m²
 Perimeter: 5.74 m

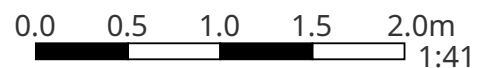
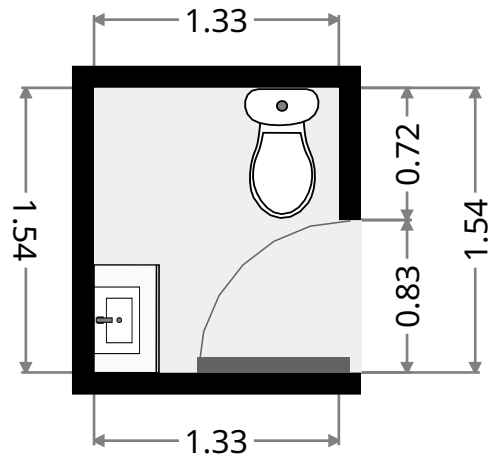
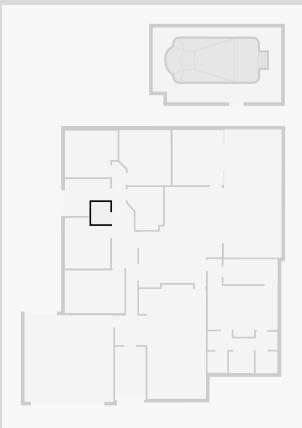

39 Nagle Drive

Bedroom

Width: 3.17 m
 Length: 3.55 m
 Area: 10.43 m²
 Perimeter: 13.44 m

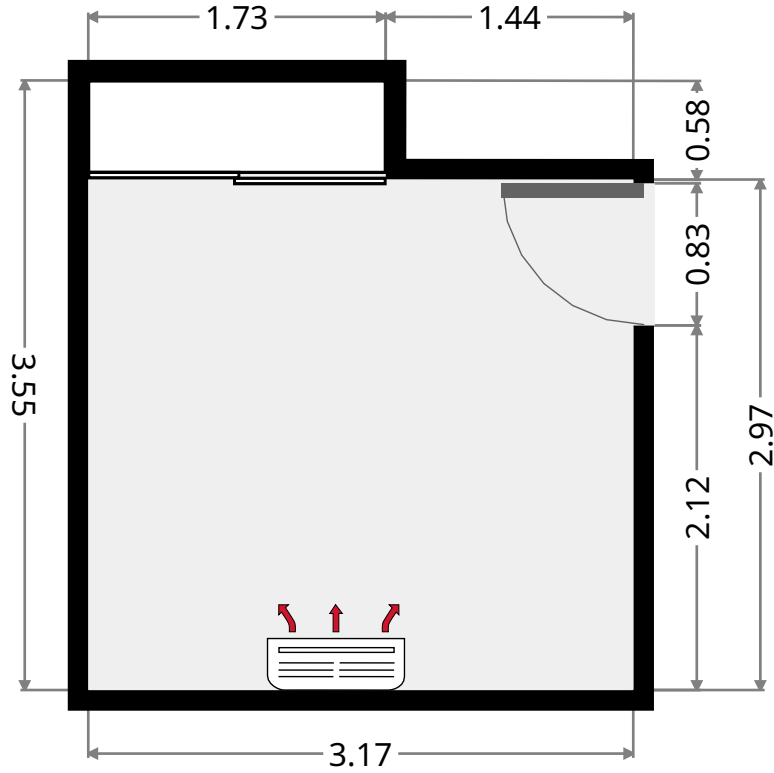
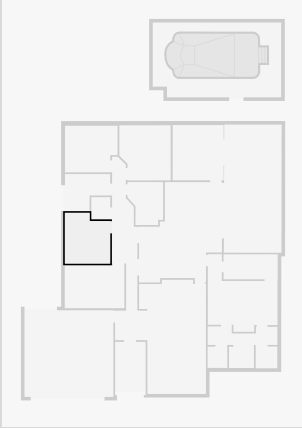

Bedroom

Width: 2.98 m
 Length: 4.18 m
 Area: 12.47 m²
 Perimeter: 14.33 m

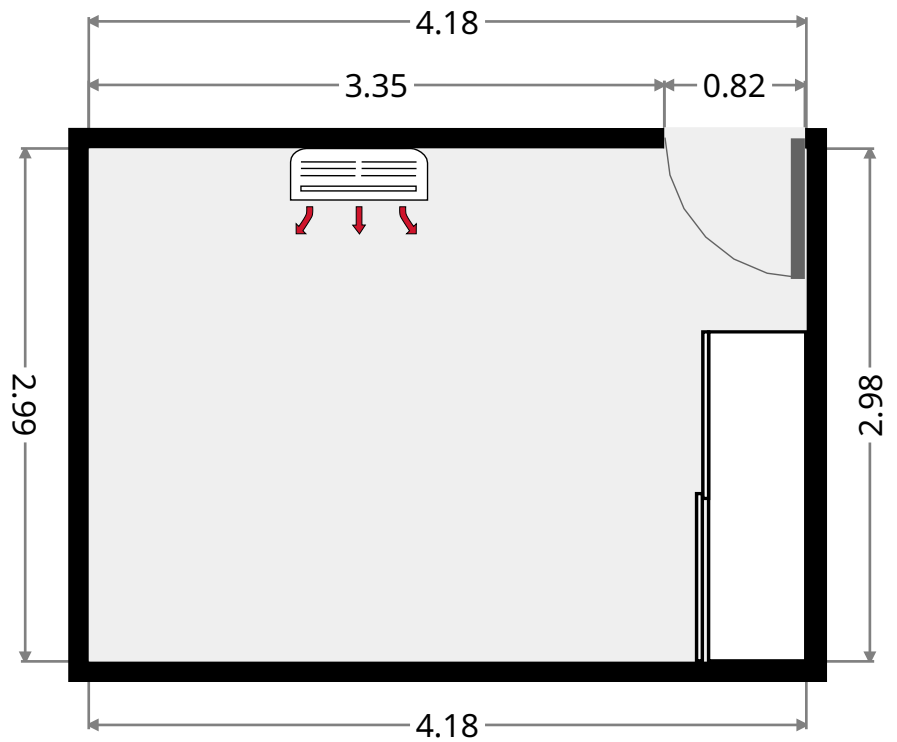
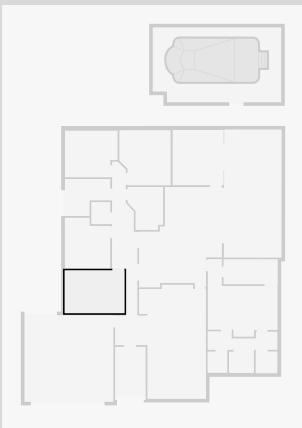

THIS FLOORPLAN IS PROVIDED WITHOUT WARRANTY OF ANY KIND. SENSOPIA DISCLAIMS ANY WARRANTY INCLUDING, WITHOUT LIMITATION, SATISFACTORY QUALITY OR ACCURACY OF DIMENSIONS.

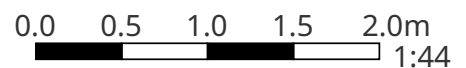

39 Nagle Drive

Hall

Width: 2.07 m
 Length: 2.14 m
 Area: 4.43 m²
 Perimeter: 8.42 m

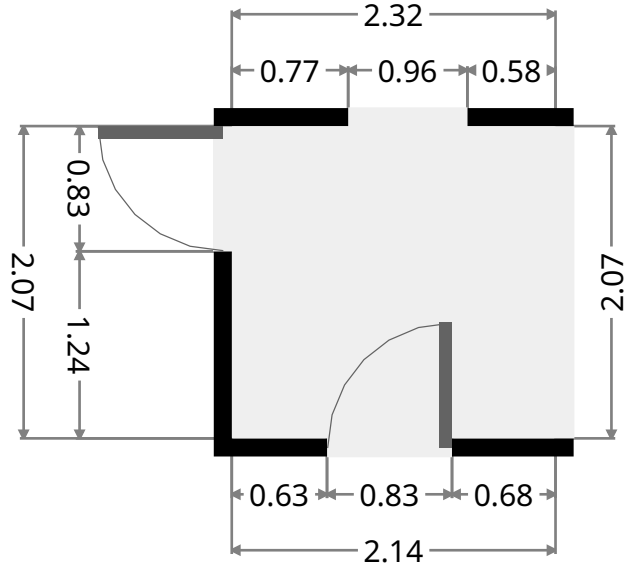
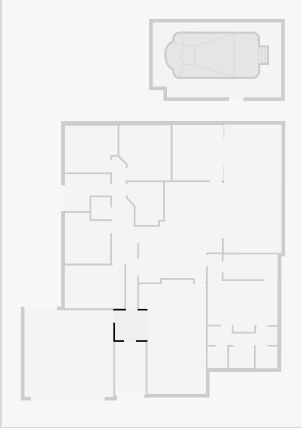

Bar Area

Width: 3.57 m
 Length: 3.87 m
 Area: 13.81 m²
 Perimeter: 14.88 m

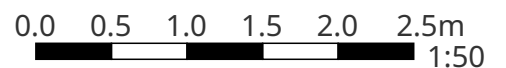
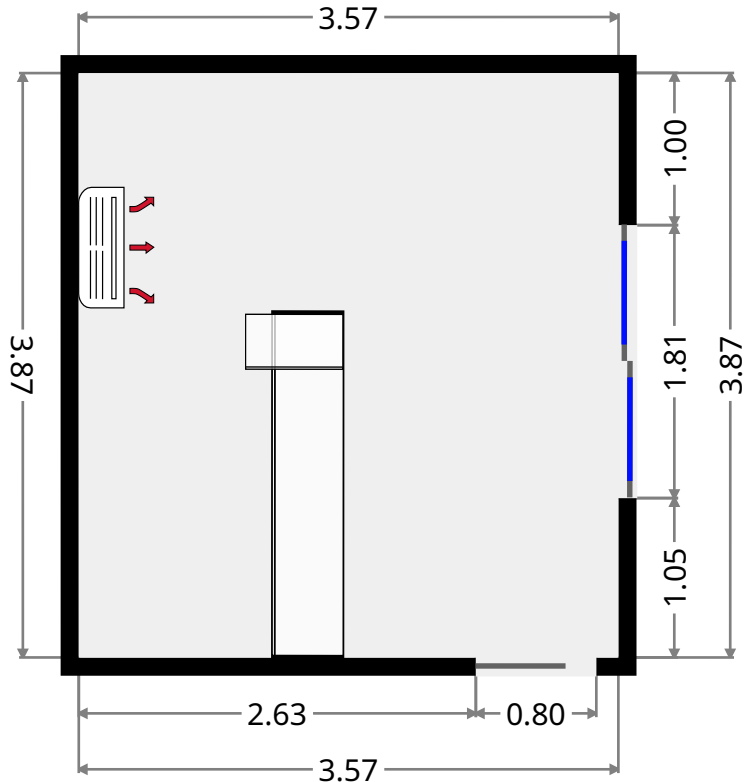
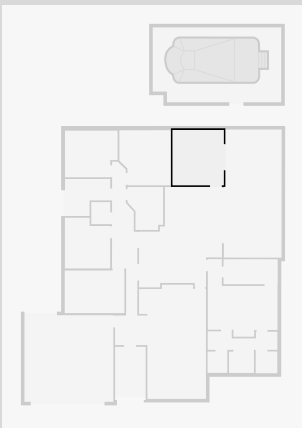

THIS FLOORPLAN IS PROVIDED WITHOUT WARRANTY OF ANY KIND. SENSOPIA DISCLAIMS ANY WARRANTY INCLUDING, WITHOUT LIMITATION, SATISFACTORY QUALITY OR ACCURACY OF DIMENSIONS.

39 Nagle Drive

Shower

Width: 1.51 m
Length: 1.53 m
Area: 2.31 m²
Perimeter: 6.07 m

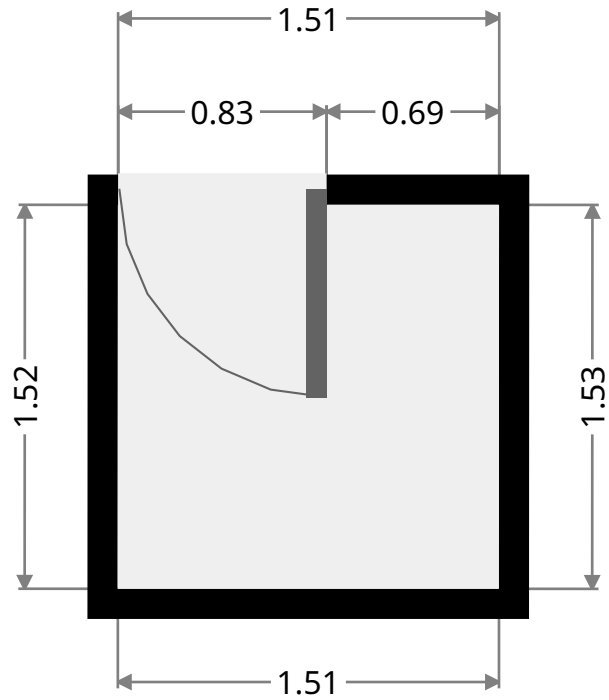
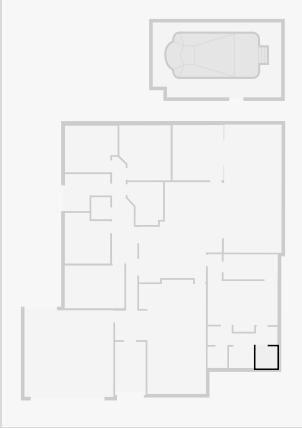

Bath

Width: 1.49 m
Length: 1.75 m
Area: 2.60 m²
Perimeter: 6.48 m

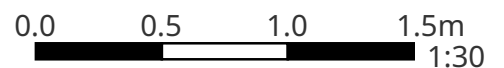
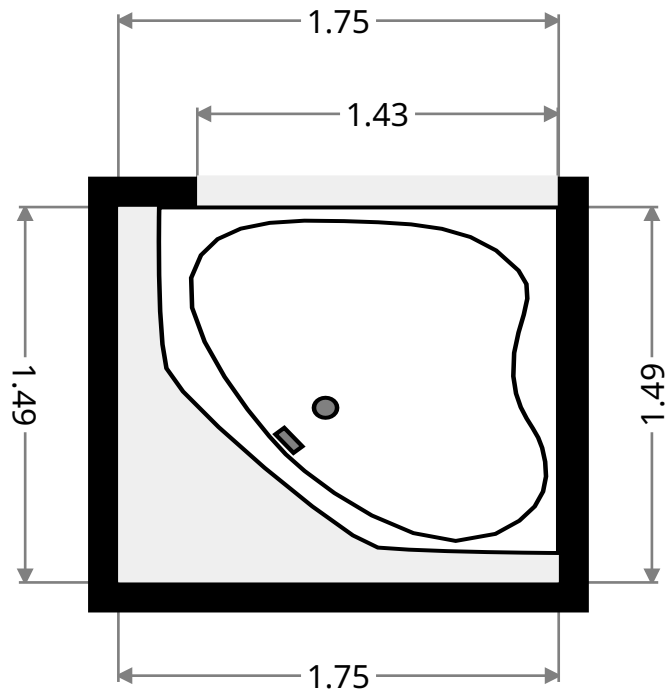
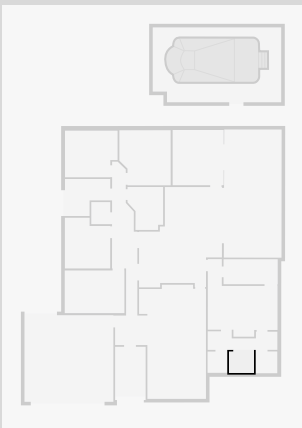

39 Nagle Drive

Toilet

Width: 1.38 m
 Length: 1.49 m
 Area: 2.06 m²
 Perimeter: 5.74 m

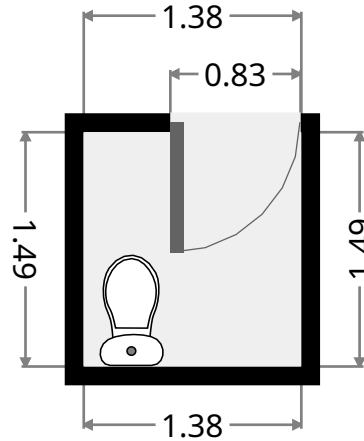
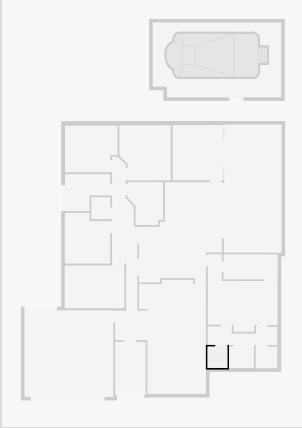

Bathroom

Width: 1.30 m
 Length: 4.88 m
 Area: 5.45 m²
 Perimeter: 13.29 m

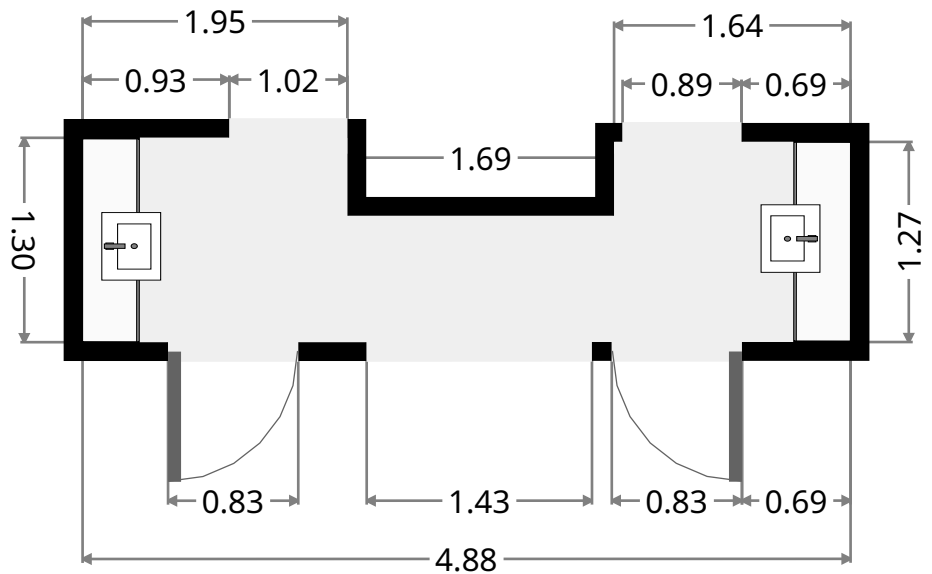
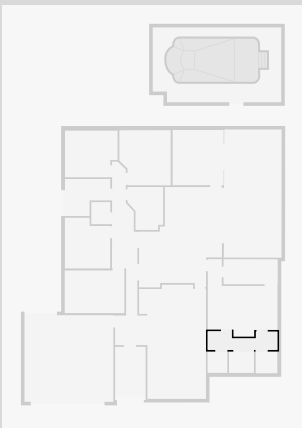

39 Nagle Drive

WIR

Width: 1.75 m
 Length: 3.79 m
 Area: 6.63 m²
 Perimeter: 11.08 m

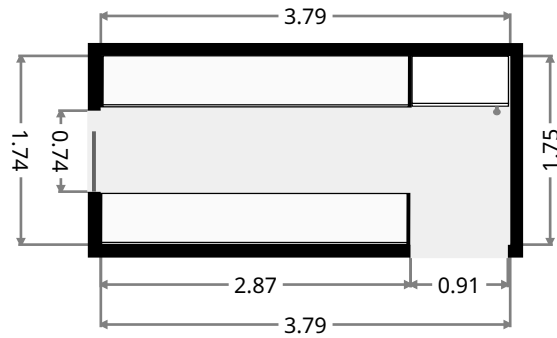
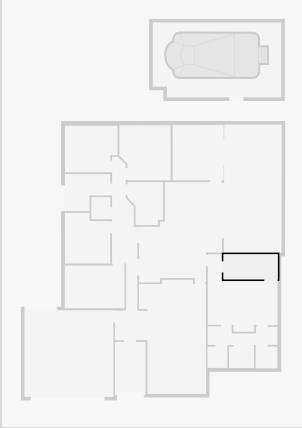

Master Bedroom

Width: 4.88 m
 Length: 5.43 m
 Area: 17.54 m²
 Perimeter: 20.63 m

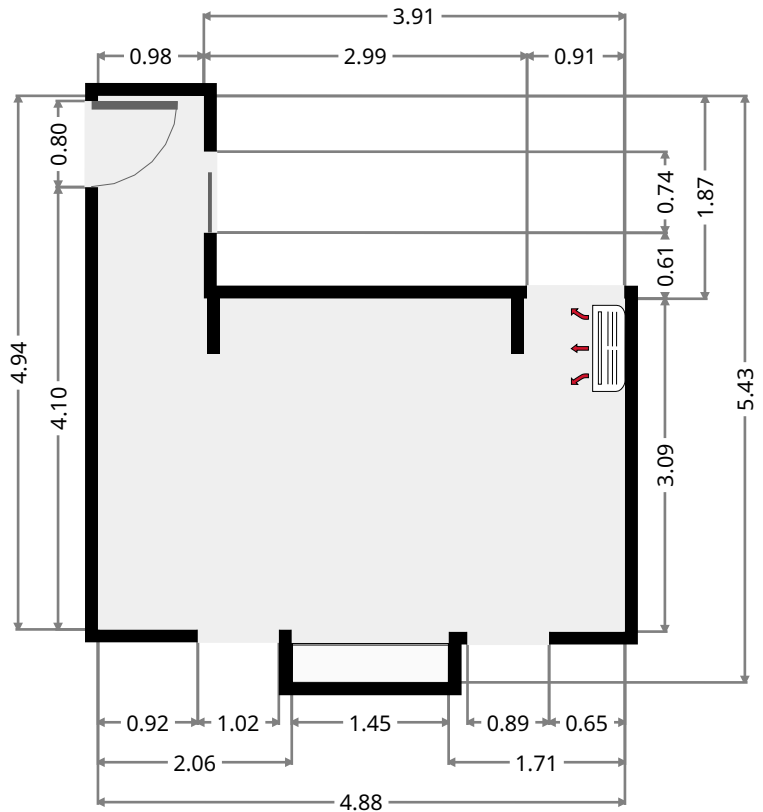
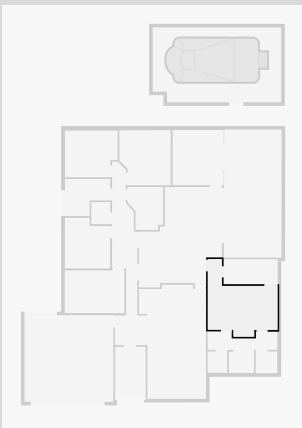

THIS FLOORPLAN IS PROVIDED WITHOUT WARRANTY OF ANY KIND. SENSOPIA DISCLAIMS ANY WARRANTY INCLUDING, WITHOUT LIMITATION, SATISFACTORY QUALITY OR ACCURACY OF DIMENSIONS.

39 Nagle Drive

Kitchen/Living/Dining

Width: 5.81 m
 Length: 7.03 m
 Area: 32.16 m²
 Perimeter: 26.23 m

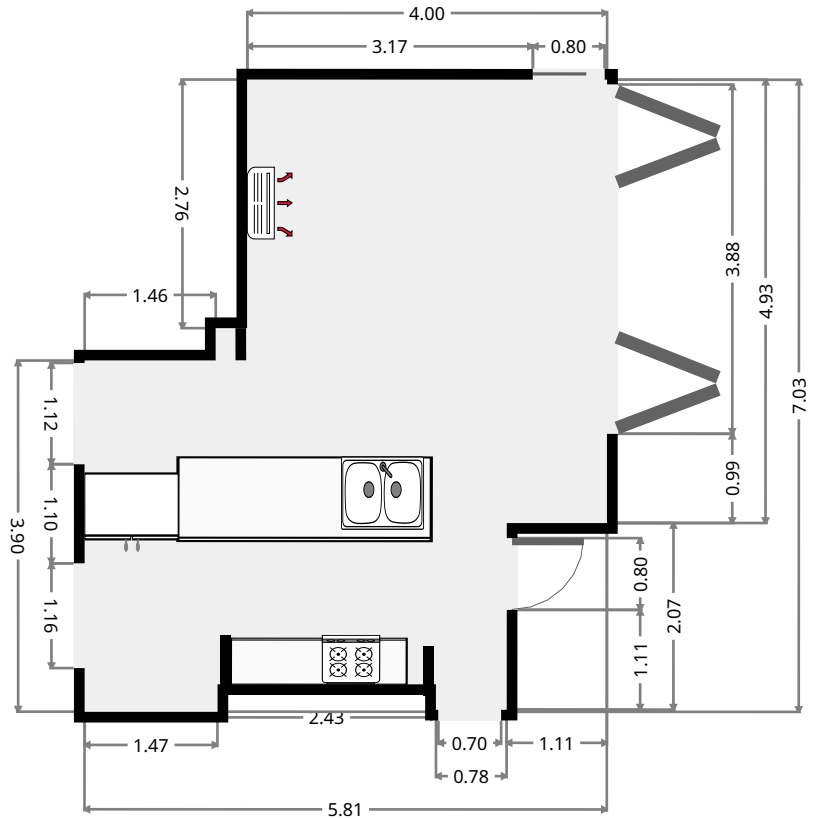
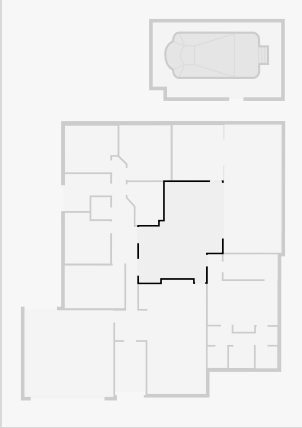

Hall

Width: 0.79 m
 Length: 3.74 m
 Area: 2.95 m²
 Perimeter: 9.06 m

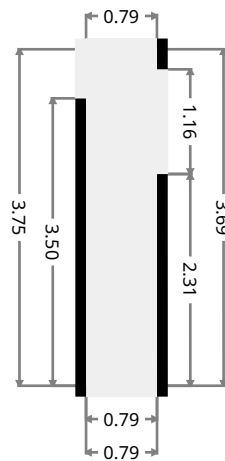
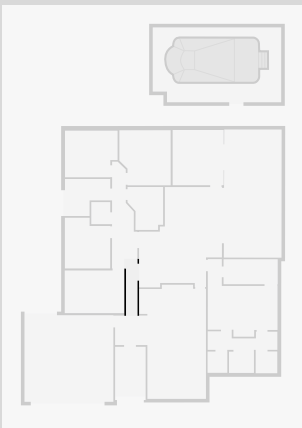

THIS FLOORPLAN IS PROVIDED WITHOUT WARRANTY OF ANY KIND. SENSOPIA DISCLAIMS ANY WARRANTY INCLUDING, WITHOUT LIMITATION, SATISFACTORY QUALITY OR ACCURACY OF DIMENSIONS.



39 Nagle Drive

Living Room

Width: 4.69 m
Length: 7.99 m
Area: 33.26 m²
Perimeter: 25.36 m

