

386 Diplock Street

Ground Floor

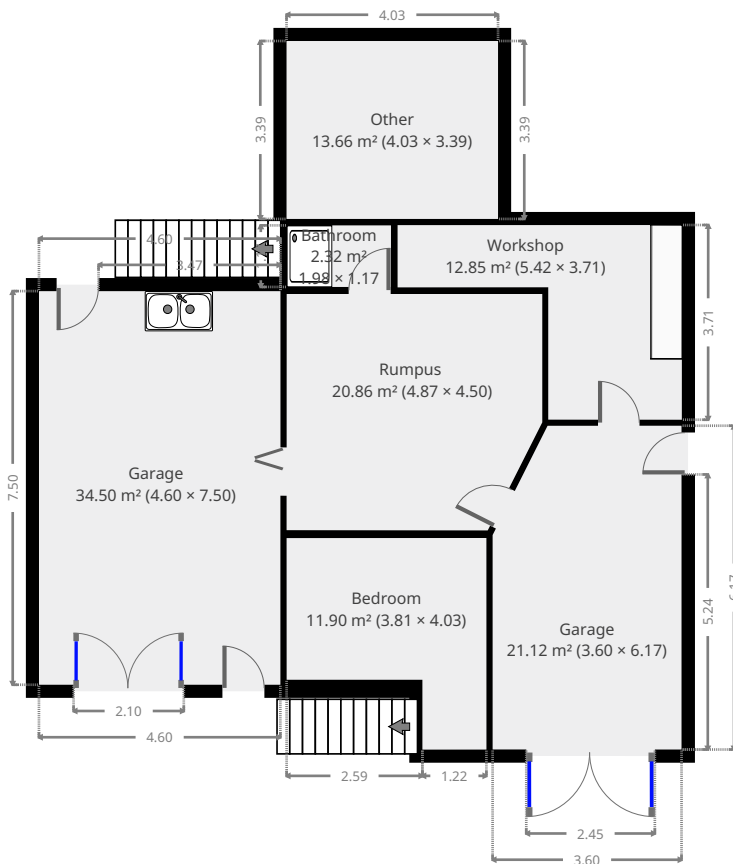

THIS FLOORPLAN IS PROVIDED WITHOUT WARRANTY OF ANY KIND. SENSOPIA DISCLAIMS ANY WARRANTY INCLUDING, WITHOUT LIMITATION, SATISFACTORY QUALITY OR ACCURACY OF DIMENSIONS.

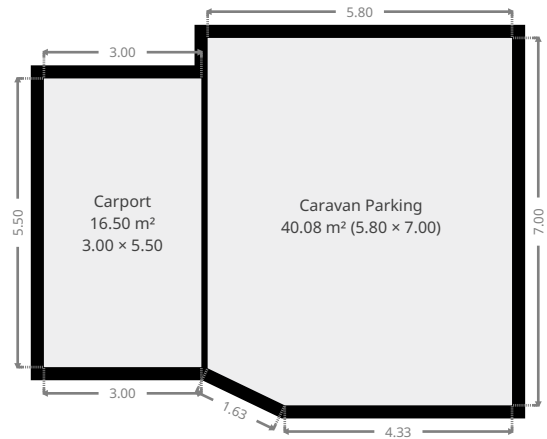

386 Diplock Street

Garage

Width: 3.60 m
 Length: 6.17 m
 Area: 21.12 m²
 Perimeter: 18.74 m

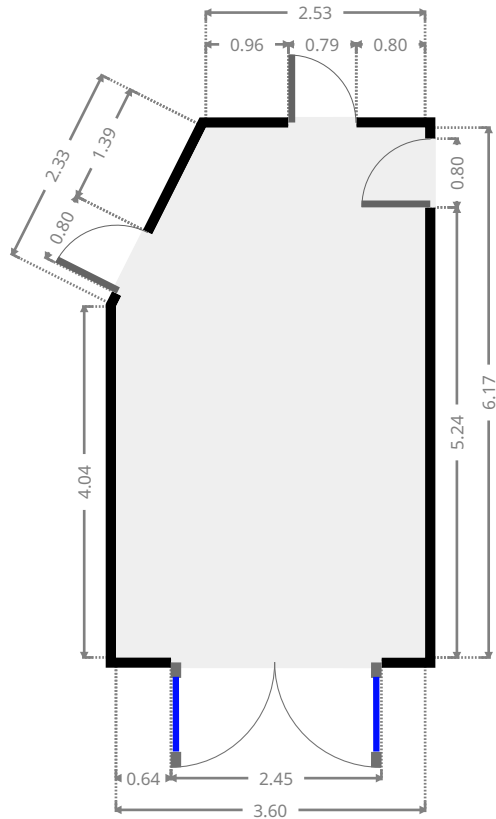
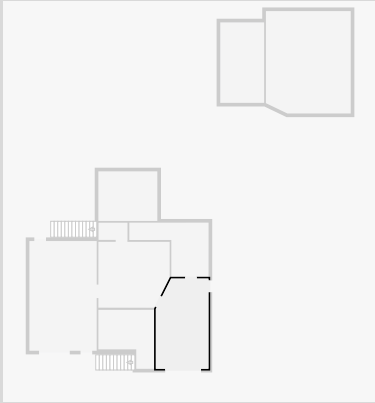

Workshop

Width: 3.71 m
 Length: 5.42 m
 Area: 12.85 m²
 Perimeter: 18.25 m

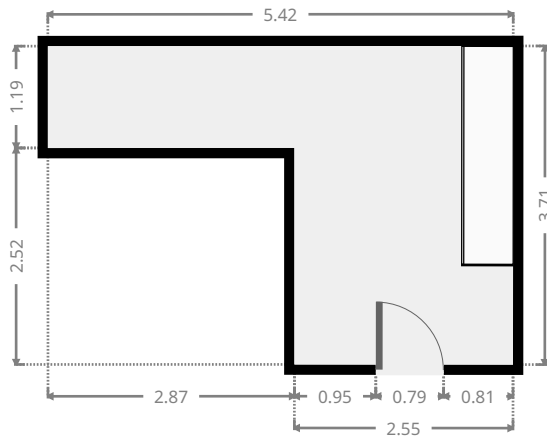
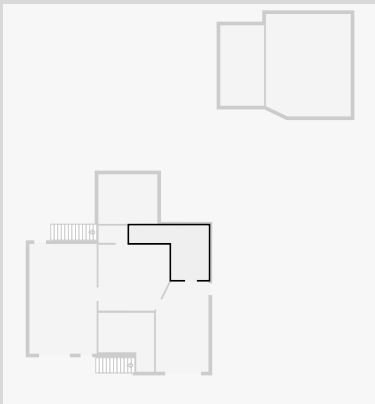

386 Diplock Street

Rumpus

Width: 4.50 m
 Length: 4.87 m
 Area: 20.86 m²
 Perimeter: 17.95 m

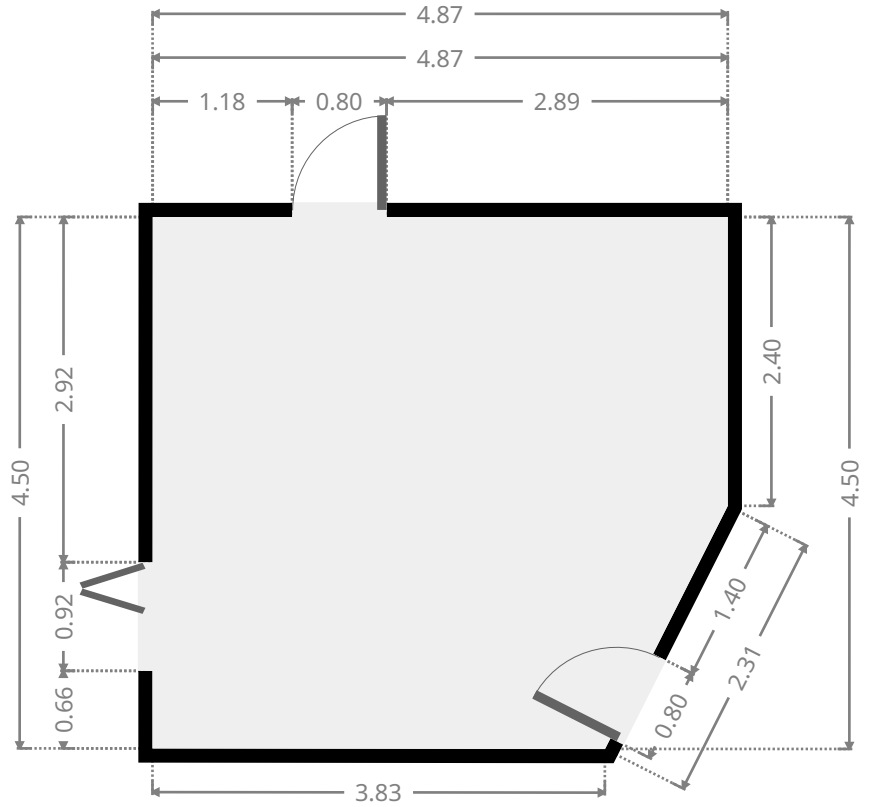
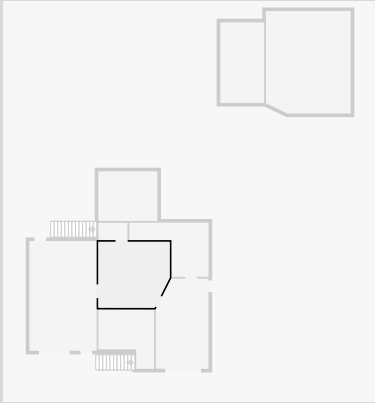

Bathroom

Width: 1.17 m
 Length: 1.98 m
 Area: 2.32 m²
 Perimeter: 6.31 m

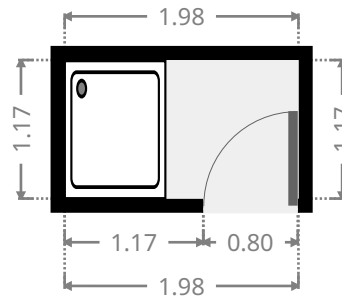
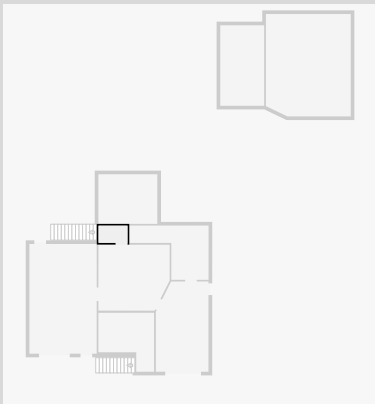

386 Diplock Street

Garage

Width: 4.60 m
 Length: 7.50 m
 Area: 34.50 m²
 Perimeter: 24.20 m

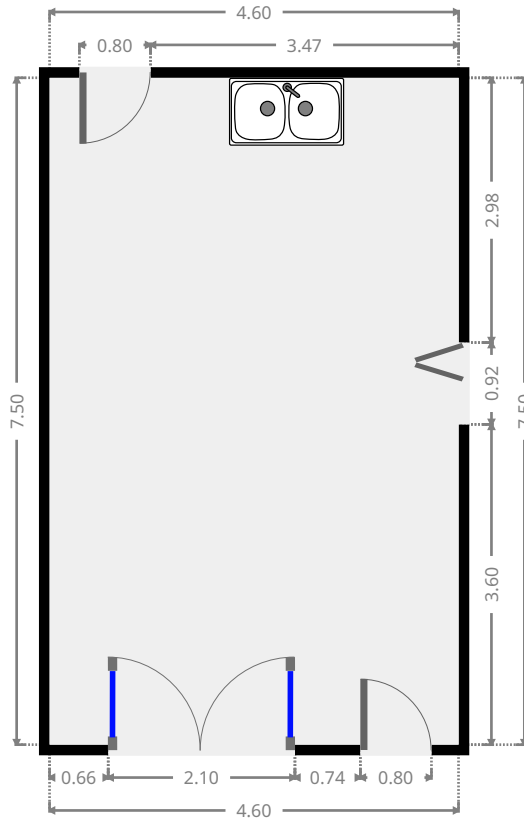
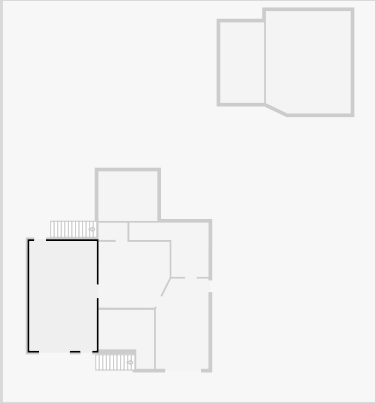

Bedroom

Width: 3.81 m
 Length: 4.03 m
 Area: 11.90 m²
 Perimeter: 15.68 m

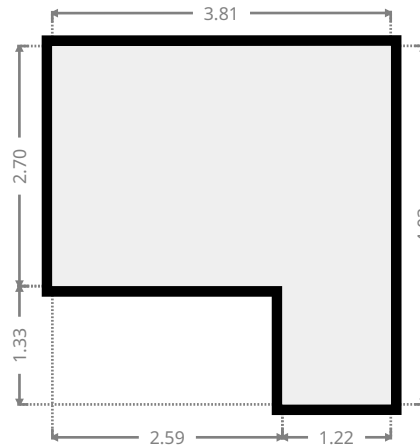
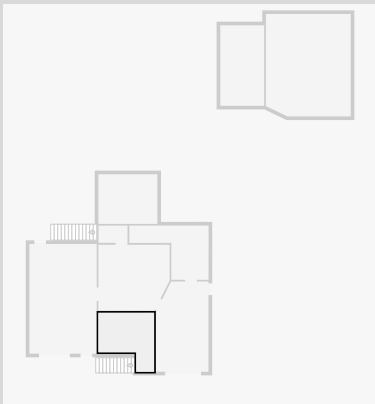

THIS FLOORPLAN IS PROVIDED WITHOUT WARRANTY OF ANY KIND. SENSOPIA DISCLAIMS ANY WARRANTY INCLUDING, WITHOUT LIMITATION, SATISFACTORY QUALITY OR ACCURACY OF DIMENSIONS.



386 Diplock Street

Other

Width: 3.39 m
Length: 4.03 m
Area: 13.66 m²
Perimeter: 14.84 m

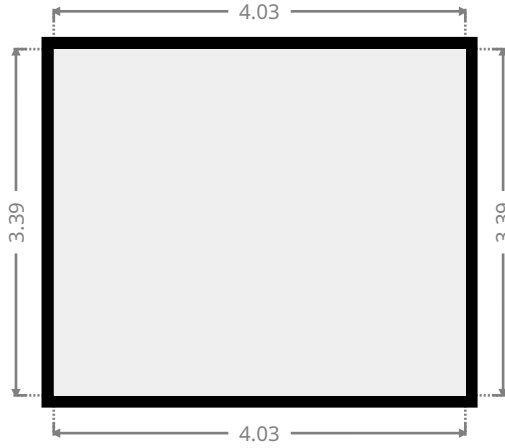
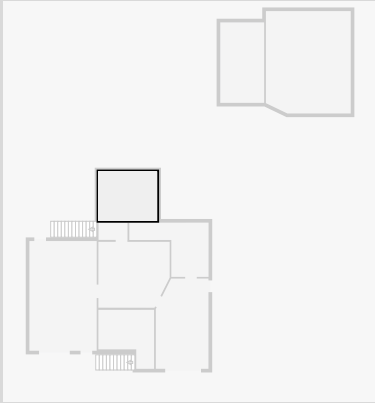

Caravan Parking

Width: 5.80 m
Length: 7.00 m
Area: 40.08 m²
Perimeter: 25.05 m

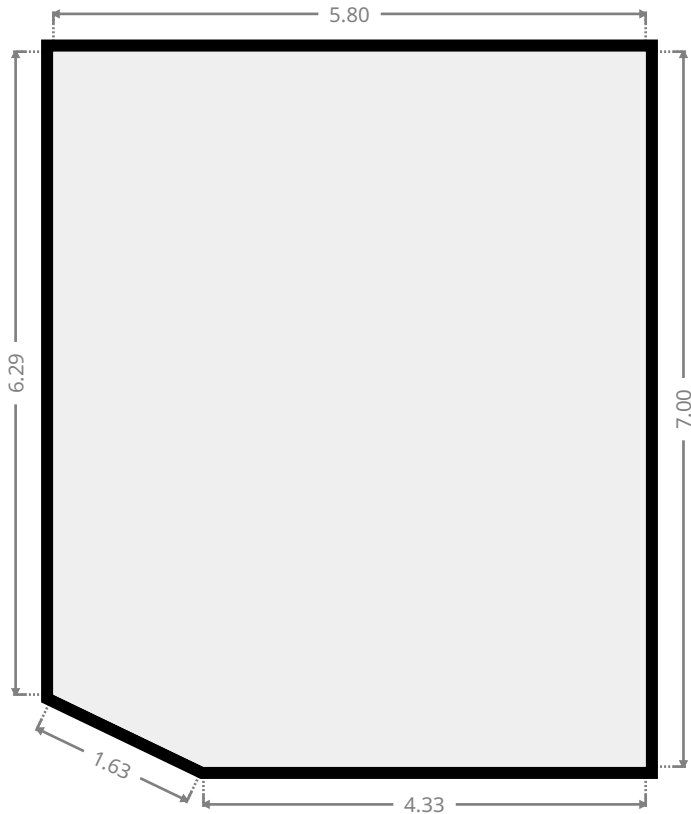
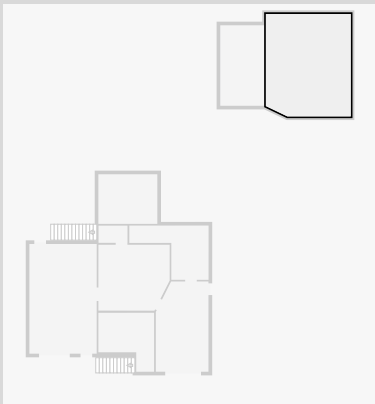

386 Diplock Street

Carport

Width:	3.00 m
Length:	5.50 m
Area	16.50 m ²
Perimeter	17.00 m

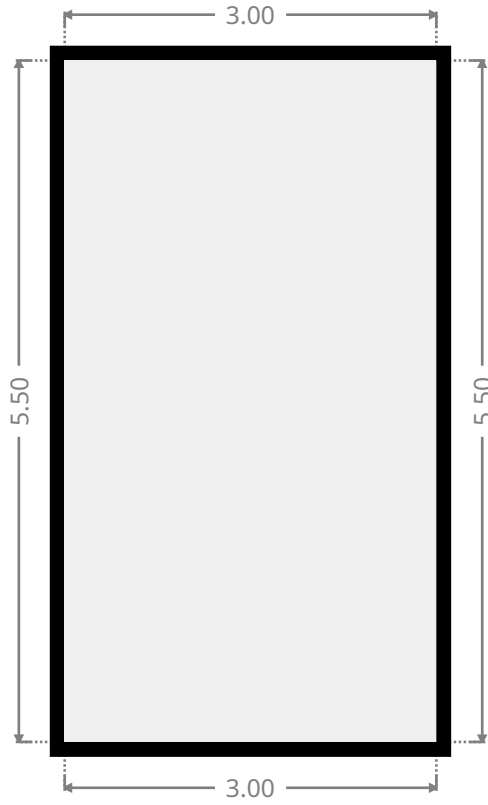
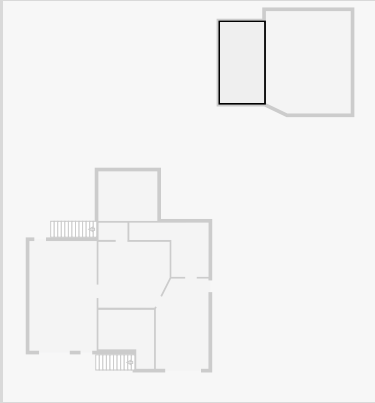

386 Diplock Street

1st Floor

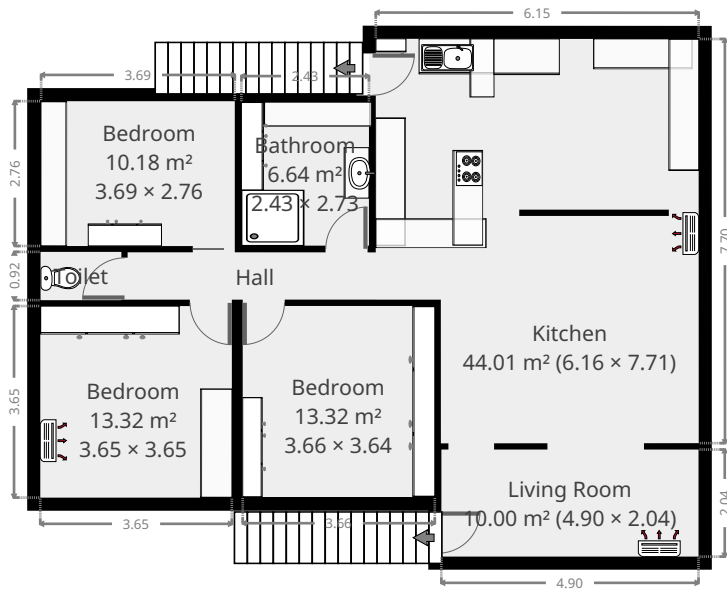

THIS FLOORPLAN IS PROVIDED WITHOUT WARRANTY OF ANY KIND. SENSOPIA DISCLAIMS ANY WARRANTY INCLUDING, WITHOUT LIMITATION, SATISFACTORY QUALITY OR ACCURACY OF DIMENSIONS.



386 Diplock Street

Living Room

Width: 2.04 m
 Length: 4.90 m
 Area: 10.00 m²
 Perimeter: 13.88 m

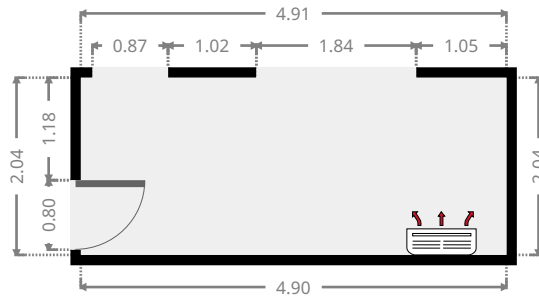
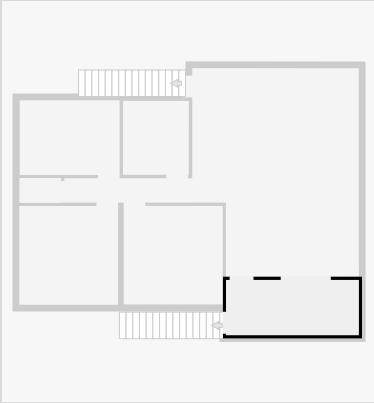

Kitchen

Width: 6.16 m
 Length: 7.71 m
 Area: 44.01 m²
 Perimeter: 27.71 m

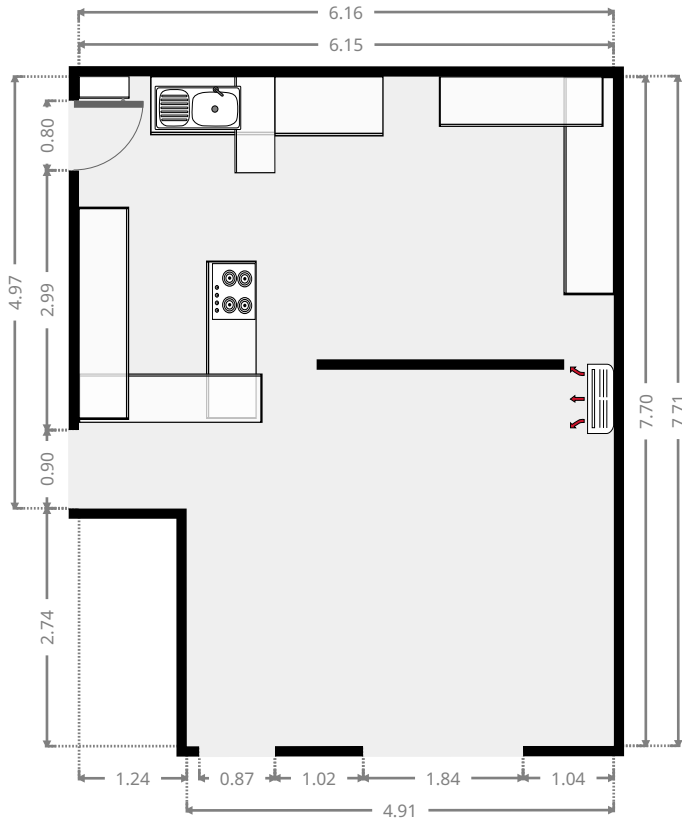
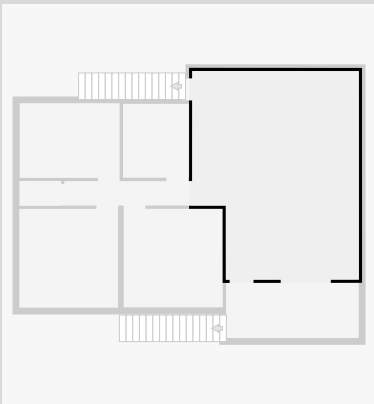

THIS FLOORPLAN IS PROVIDED WITHOUT WARRANTY OF ANY KIND. SENSOPIA DISCLAIMS ANY WARRANTY INCLUDING, WITHOUT LIMITATION, SATISFACTORY QUALITY OR ACCURACY OF DIMENSIONS.

386 Diplock Street

Hall

Width: 0.90 m
 Length: 4.60 m
 Area: 4.14 m²
 Perimeter: 11.00 m

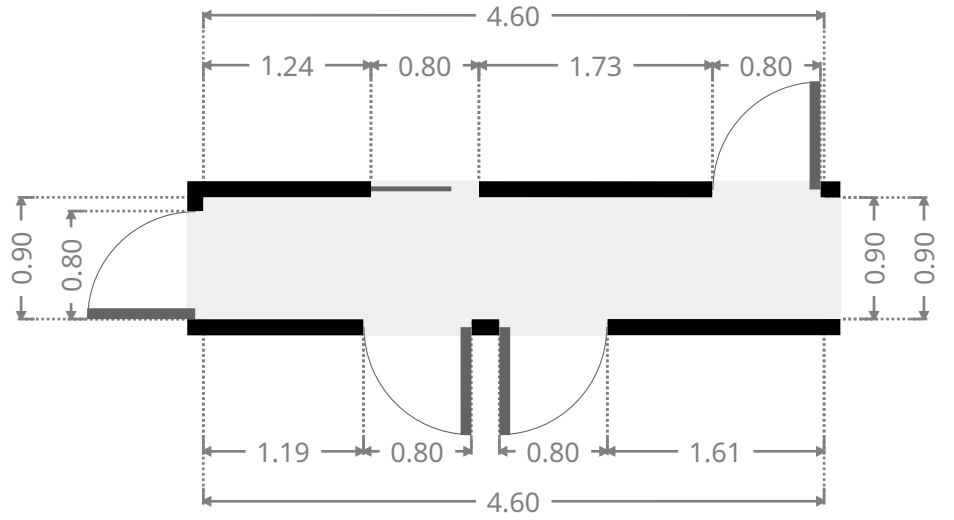
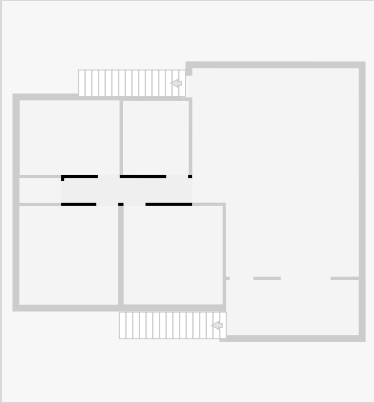

Bathroom

Width: 2.43 m
 Length: 2.73 m
 Area: 6.64 m²
 Perimeter: 10.32 m

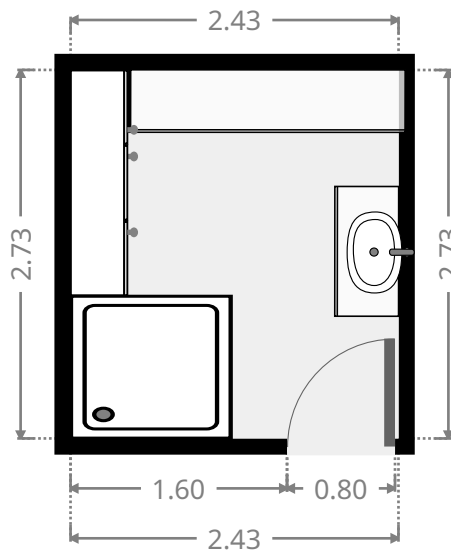
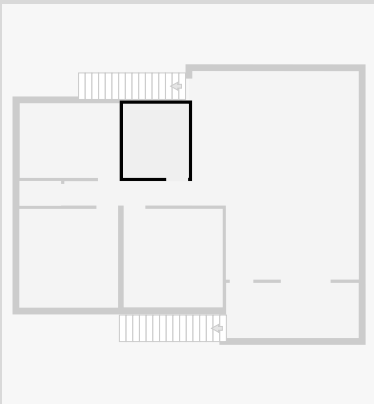

THIS FLOORPLAN IS PROVIDED WITHOUT WARRANTY OF ANY KIND. SENSOPIA DISCLAIMS ANY WARRANTY INCLUDING, WITHOUT LIMITATION, SATISFACTORY QUALITY OR ACCURACY OF DIMENSIONS.

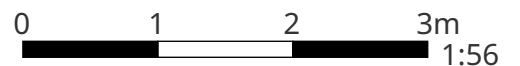

386 Diplock Street

Bedroom

Width: 3.64 m
 Length: 3.66 m
 Area: 13.32 m²
 Perimeter: 14.60 m

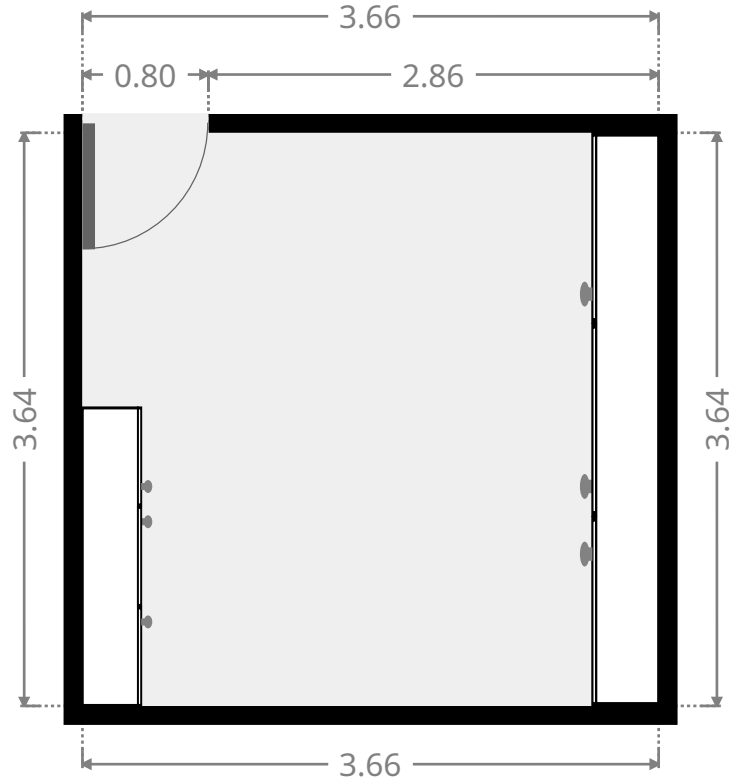
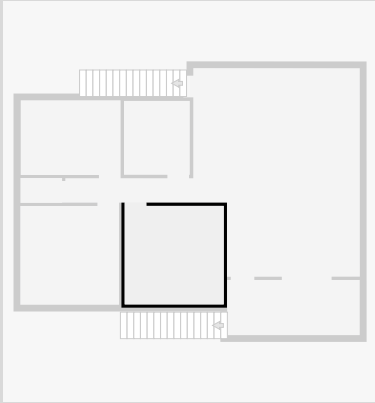

Bedroom

Width: 3.65 m
 Length: 3.65 m
 Area: 13.32 m²
 Perimeter: 14.60 m

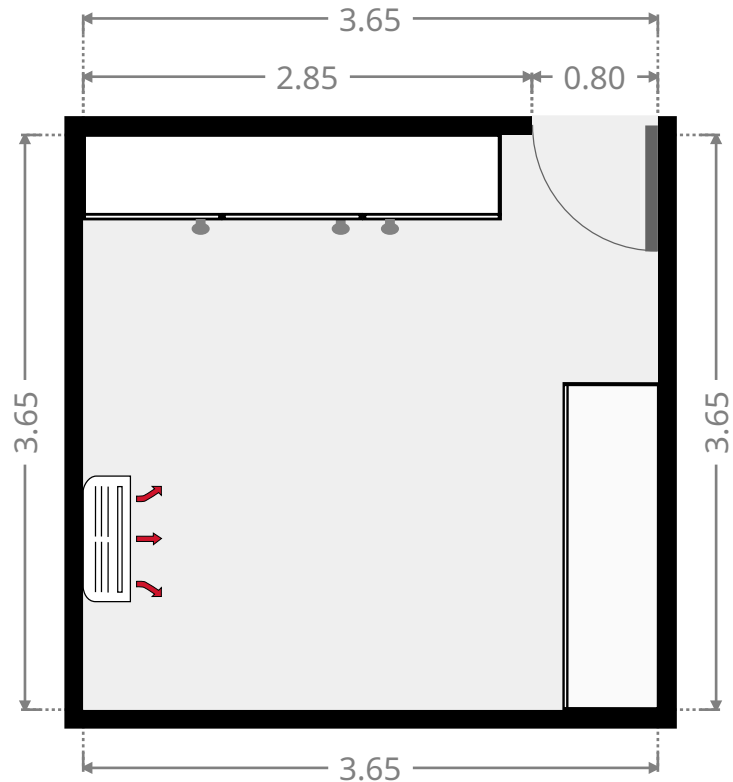
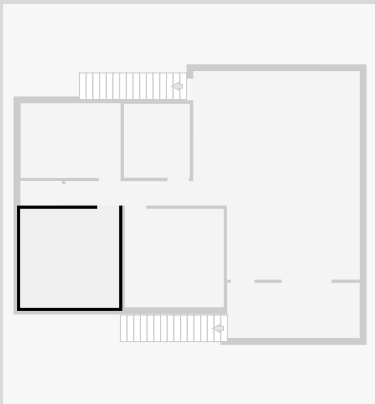

THIS FLOORPLAN IS PROVIDED WITHOUT WARRANTY OF ANY KIND. SENSOPIA DISCLAIMS ANY WARRANTY INCLUDING, WITHOUT LIMITATION, SATISFACTORY QUALITY OR ACCURACY OF DIMENSIONS.

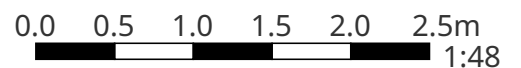

386 Diplock Street

Toilet / Half Bath

Width: 0.92 m
Length: 1.54 m
Area: 1.42 m²
Perimeter: 4.92 m

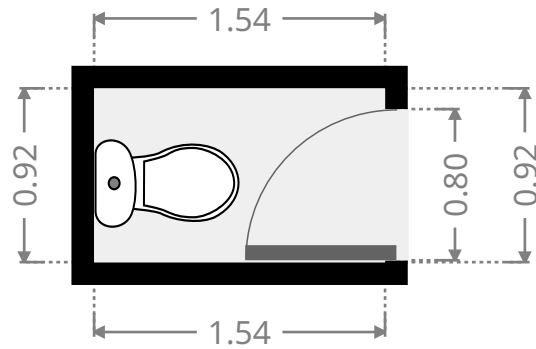
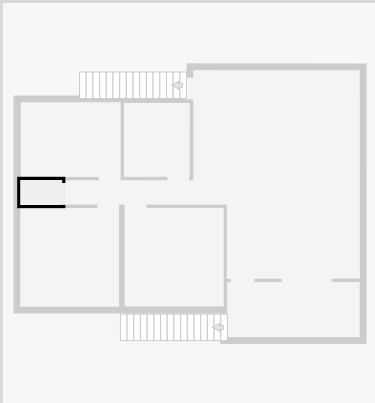

Bedroom

Width: 2.76 m
Length: 3.69 m
Area: 10.18 m²
Perimeter: 12.90 m

