

# 381 Rockonia Road

## Ground Floor

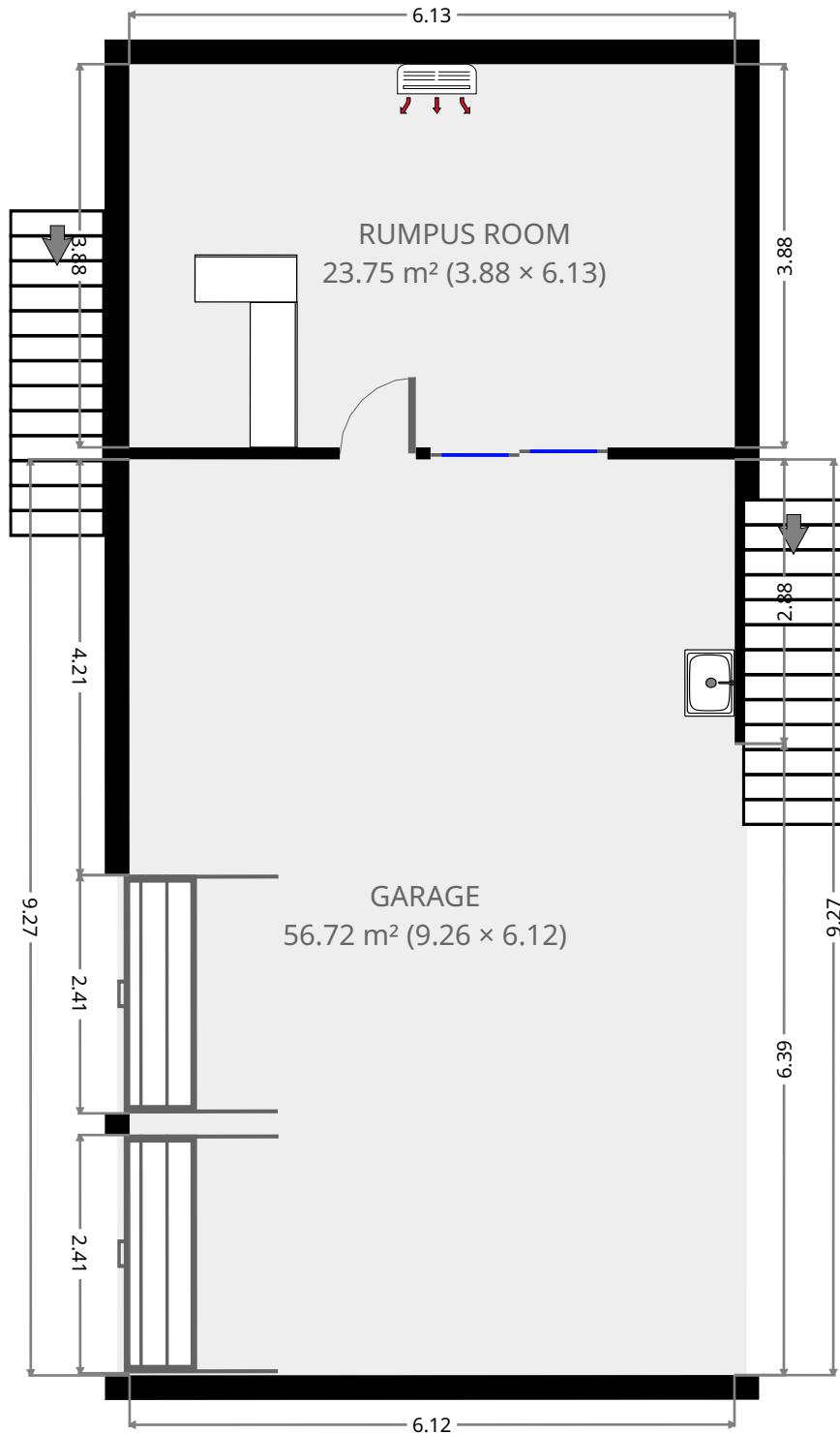

THIS FLOORPLAN IS PROVIDED WITHOUT WARRANTY OF ANY KIND. SENSOPIA DISCLAIMS ANY WARRANTY INCLUDING, WITHOUT LIMITATION, SATISFACTORY QUALITY OR ACCURACY OF DIMENSIONS.



# 381 Rockonia Road

## Garage

Width: 6.12 m  
Length: 9.26 m  
Area: 56.72 m<sup>2</sup>  
Perimeter: 30.77 m

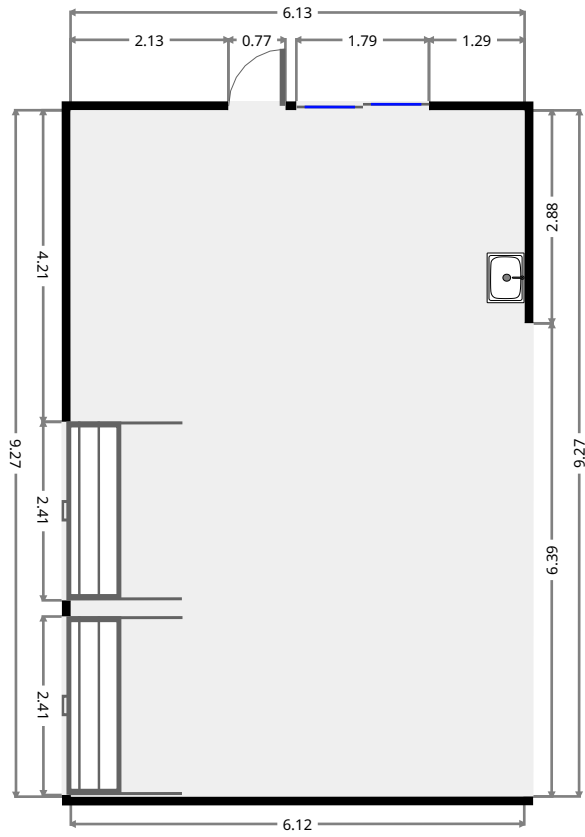
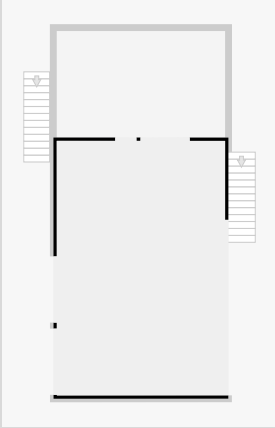

## Rumpus Room

Width: 3.88 m  
Length: 6.13 m  
Area: 23.75 m<sup>2</sup>  
Perimeter: 20.01 m

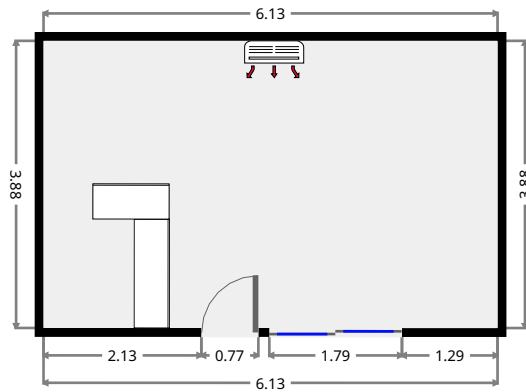
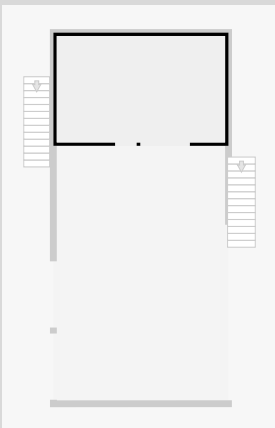

# 381 Rockonia Road

## 1st Floor

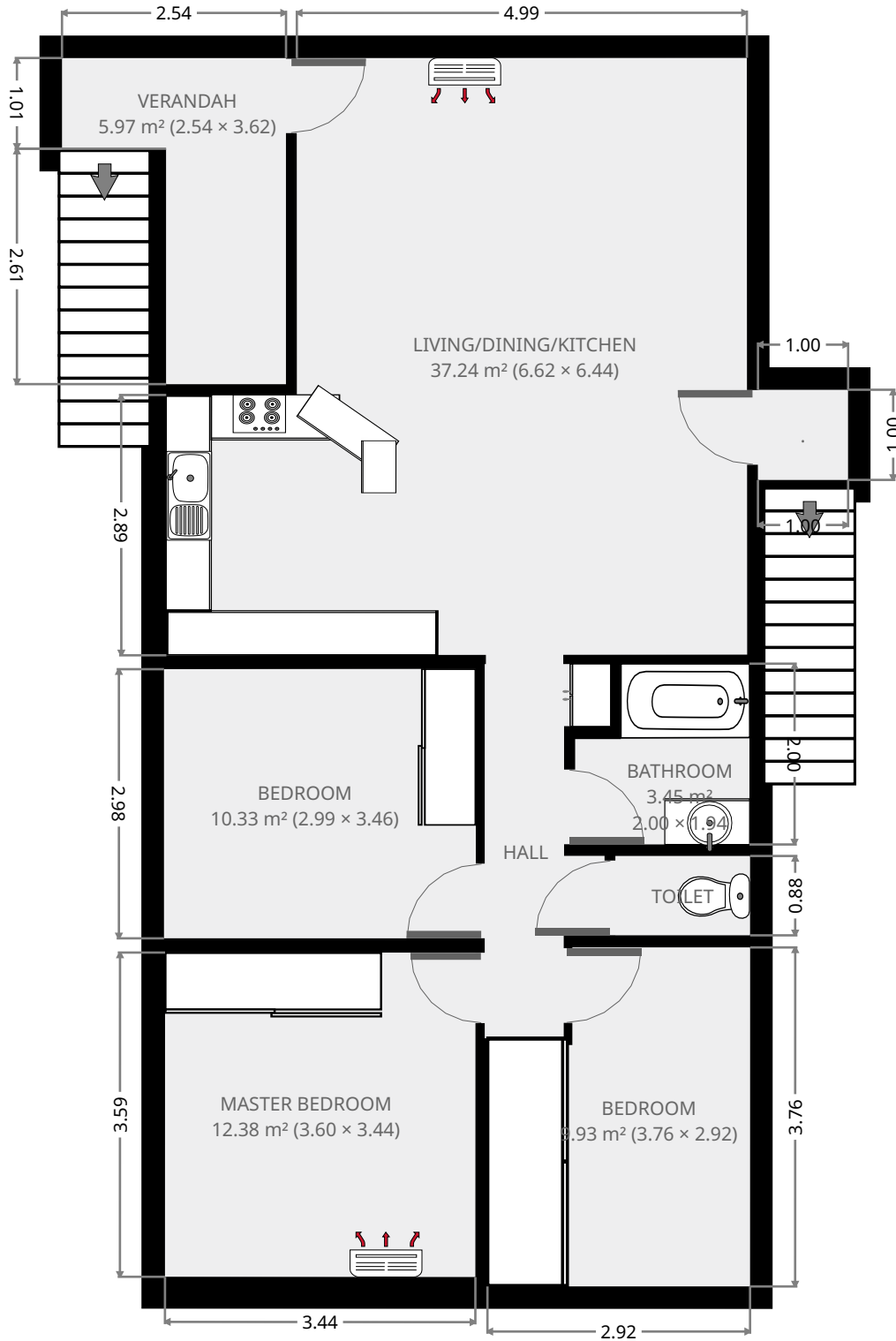

THIS FLOORPLAN IS PROVIDED WITHOUT WARRANTY OF ANY KIND. SENSOPIA DISCLAIMS ANY WARRANTY INCLUDING, WITHOUT LIMITATION, SATISFACTORY QUALITY OR ACCURACY OF DIMENSIONS.



# 381 Rockonia Road

## Living/Dining/Kitchen

Width: 6.44 m  
 Length: 6.62 m  
 Area: 37.24 m<sup>2</sup>  
 Perimeter: 26.13 m

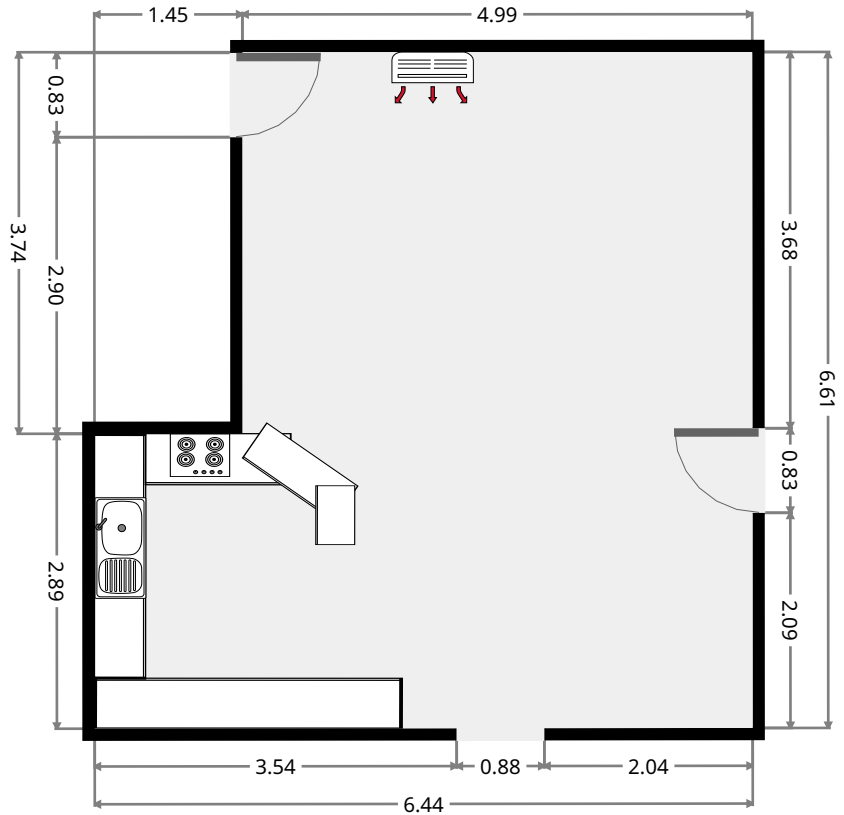
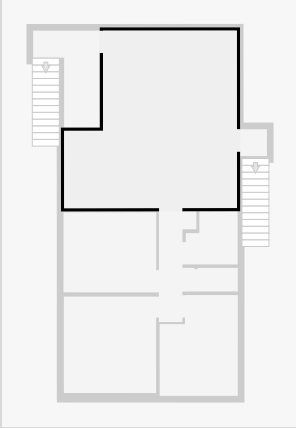

## Hall

Width: 1.40 m  
 Length: 4.16 m  
 Area: 4.40 m<sup>2</sup>  
 Perimeter: 12.00 m

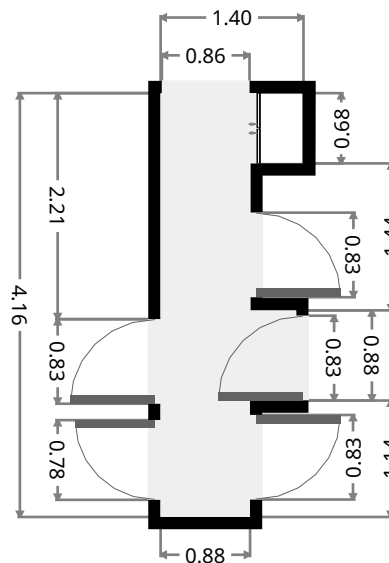
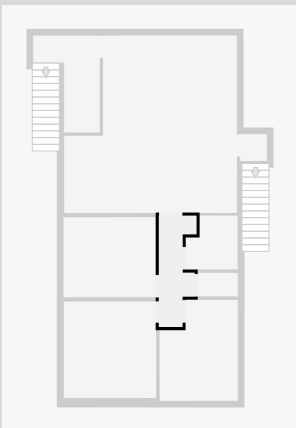

THIS FLOORPLAN IS PROVIDED WITHOUT WARRANTY OF ANY KIND. SENSOPIA DISCLAIMS ANY WARRANTY INCLUDING, WITHOUT LIMITATION, SATISFACTORY QUALITY OR ACCURACY OF DIMENSIONS.

# 381 Rockonia Road

## Bathroom

Width: 1.94 m  
Length: 2.00 m  
Area: 3.45 m<sup>2</sup>  
Perimeter: 7.88 m

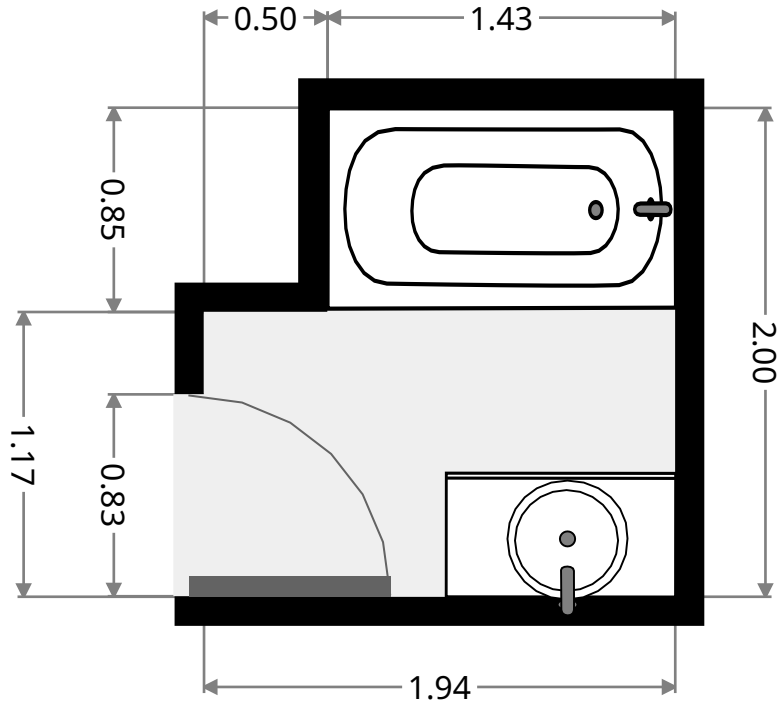
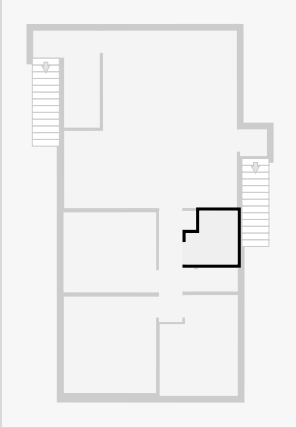

## Toilet

Width: 0.88 m  
Length: 1.50 m  
Area: 1.31 m<sup>2</sup>  
Perimeter: 4.75 m

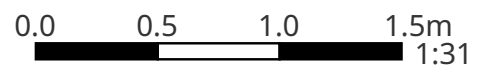
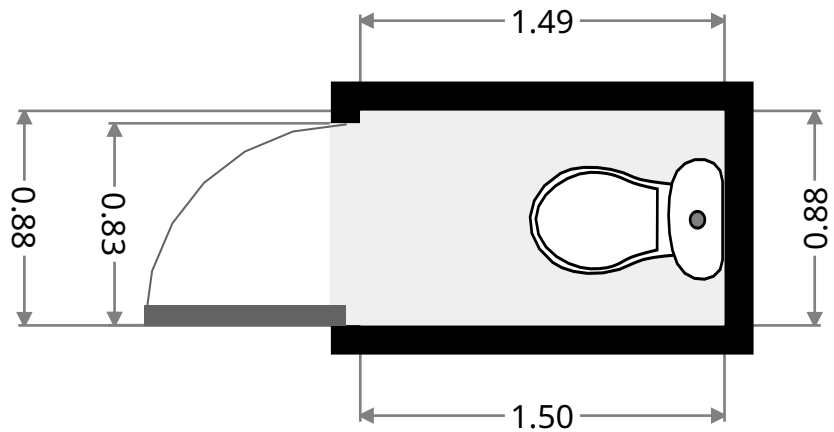
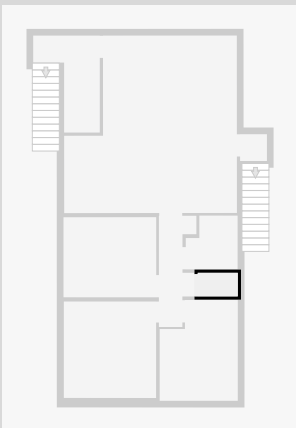

# 381 Rockonia Road

## Bedroom

Width: 2.92 m  
 Length: 3.76 m  
 Area: 9.93 m<sup>2</sup>  
 Perimeter: 13.35 m

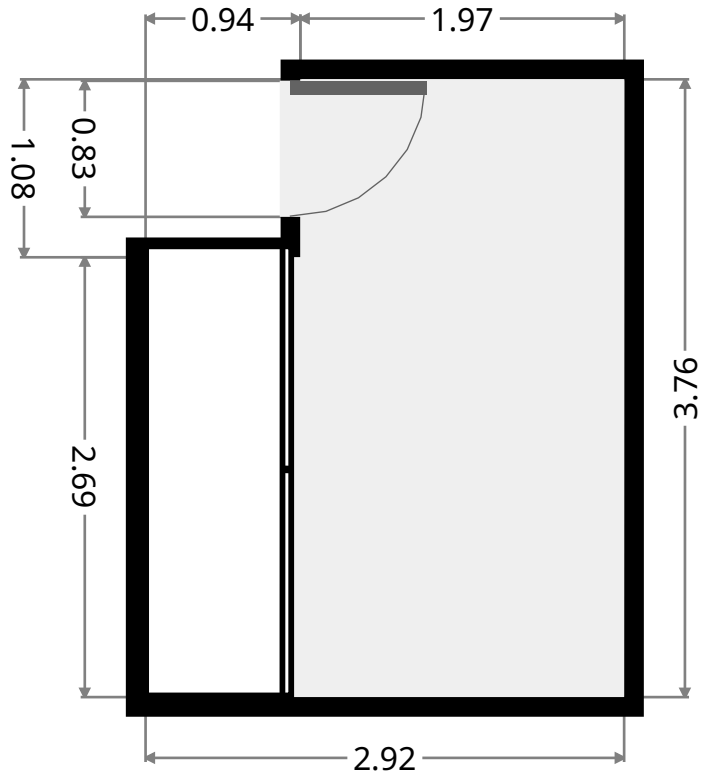
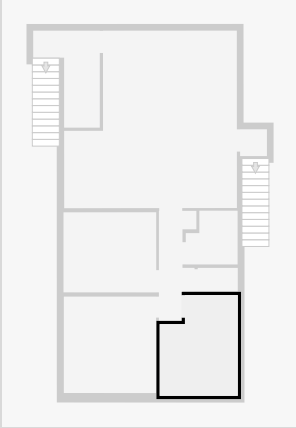

## Master Bedroom

Width: 3.44 m  
 Length: 3.60 m  
 Area: 12.38 m<sup>2</sup>  
 Perimeter: 14.08 m

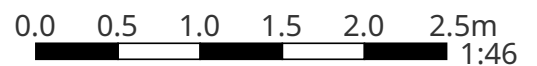
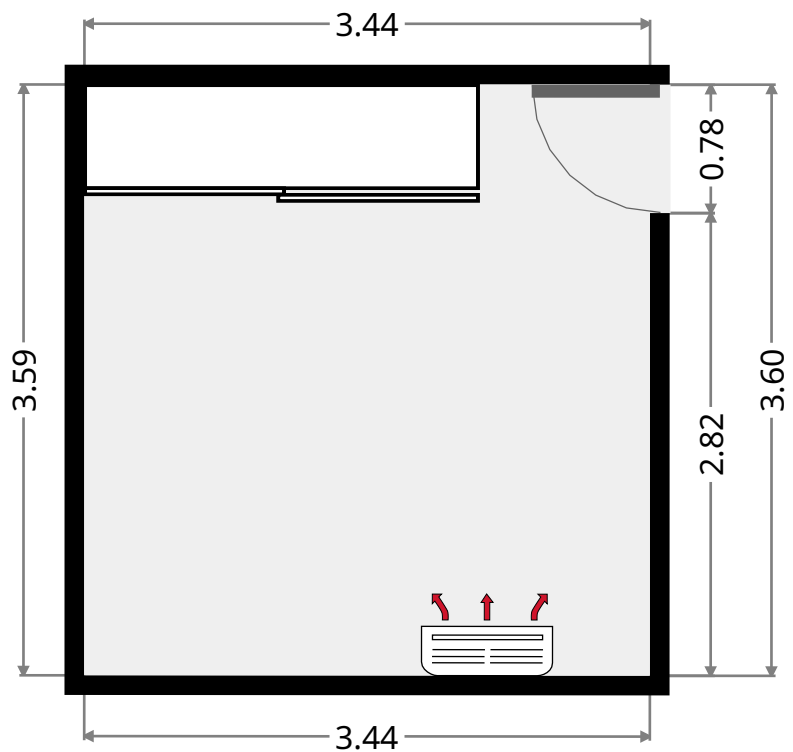
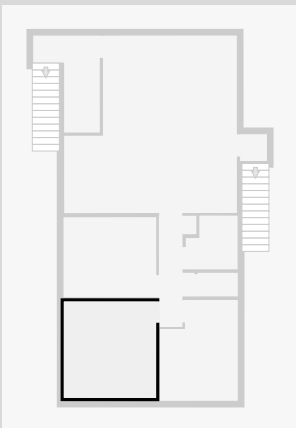

THIS FLOORPLAN IS PROVIDED WITHOUT WARRANTY OF ANY KIND. SENSOPIA DISCLAIMS ANY WARRANTY INCLUDING, WITHOUT LIMITATION, SATISFACTORY QUALITY OR ACCURACY OF DIMENSIONS.

# 381 Rockonia Road

## Bedroom

Width: 2.99 m  
Length: 3.46 m  
Area: 10.33 m<sup>2</sup>  
Perimeter: 12.89 m

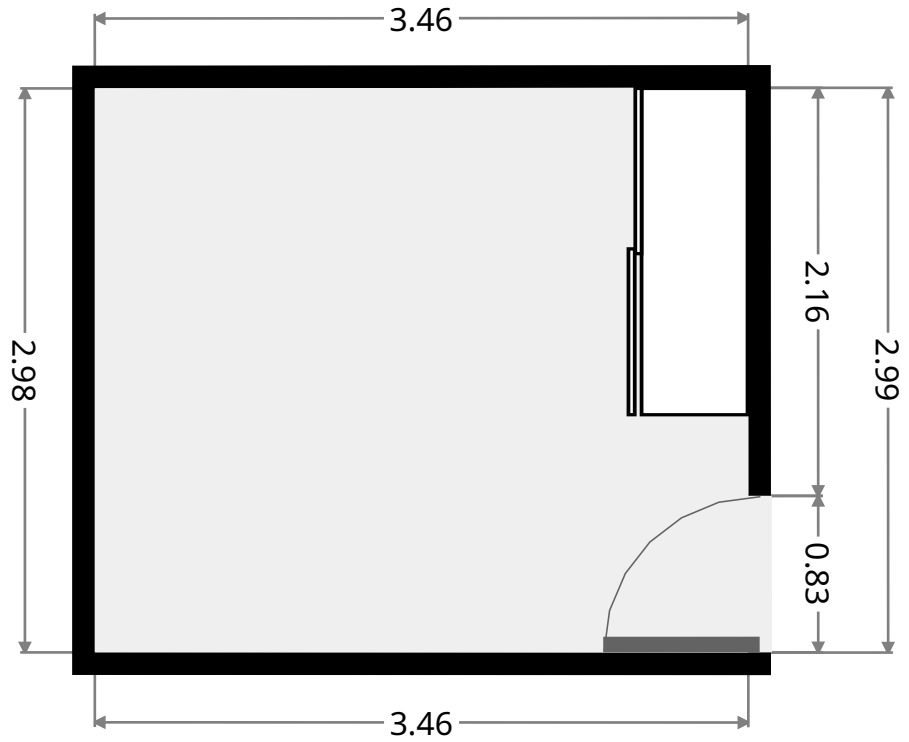
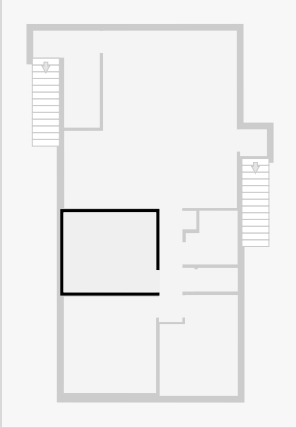

•  
Width: 1.00 m  
Length: 1.00 m  
Area: 1.00 m<sup>2</sup>  
Perimeter: 4.00 m

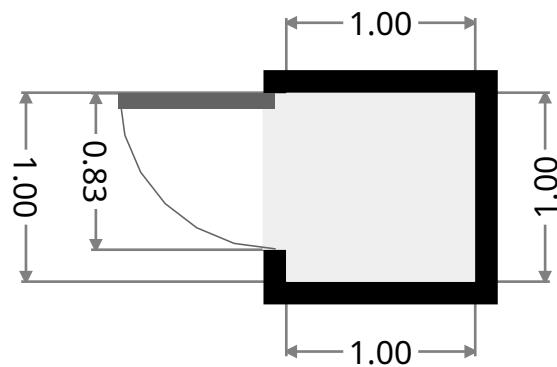
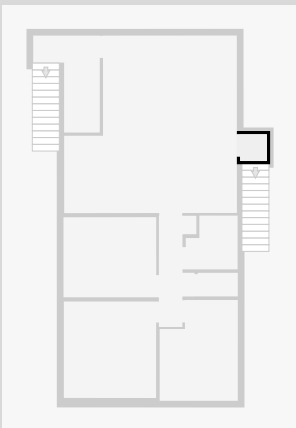

# 381 Rockonia Road

## Verandah

Width: 2.54 m  
Length: 3.62 m  
Area: 5.97 m<sup>2</sup>  
Perimeter: 12.21 m

