

# 379 Lilley Avenue

## Ground Floor



THIS FLOORPLAN IS PROVIDED WITHOUT WARRANTY OF ANY KIND. SENSOPIA DISCLAIMS ANY WARRANTY INCLUDING, WITHOUT LIMITATION, SATISFACTORY QUALITY OR ACCURACY OF DIMENSIONS.



# 379 Lilley Avenue

## Living Room

Width: 4.19 m  
 Length: 4.27 m  
 Area: 17.86 m<sup>2</sup>  
 Perimeter: 16.90 m

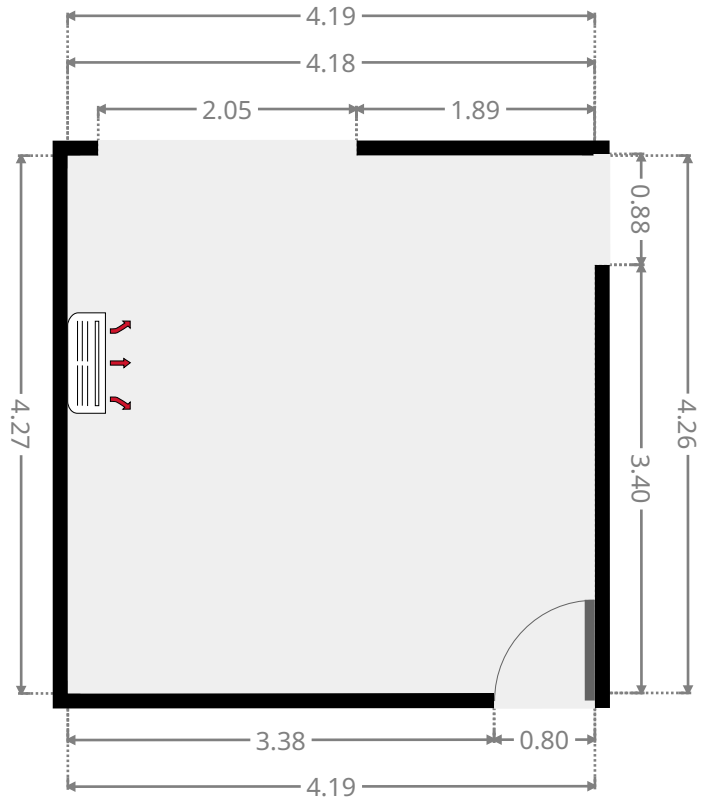
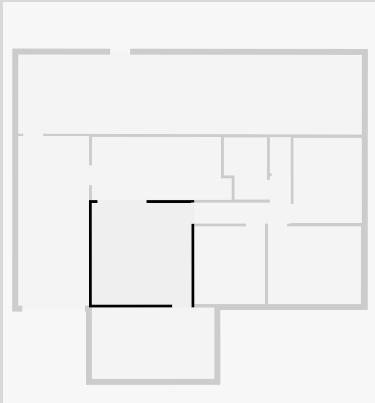

## Hallway

Width: 2.00 m  
 Length: 4.07 m  
 Area: 4.58 m<sup>2</sup>  
 Perimeter: 12.15 m

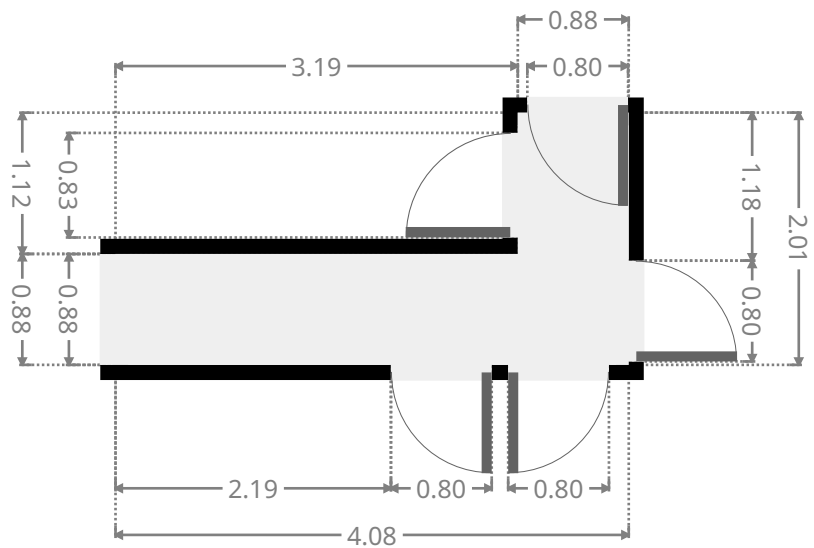
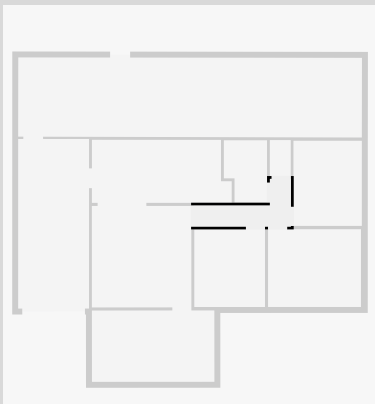

# 379 Lilley Avenue

## Bedroom

Width: 2.97 m  
 Length: 3.27 m  
 Area: 9.72 m<sup>2</sup>  
 Perimeter: 12.48 m

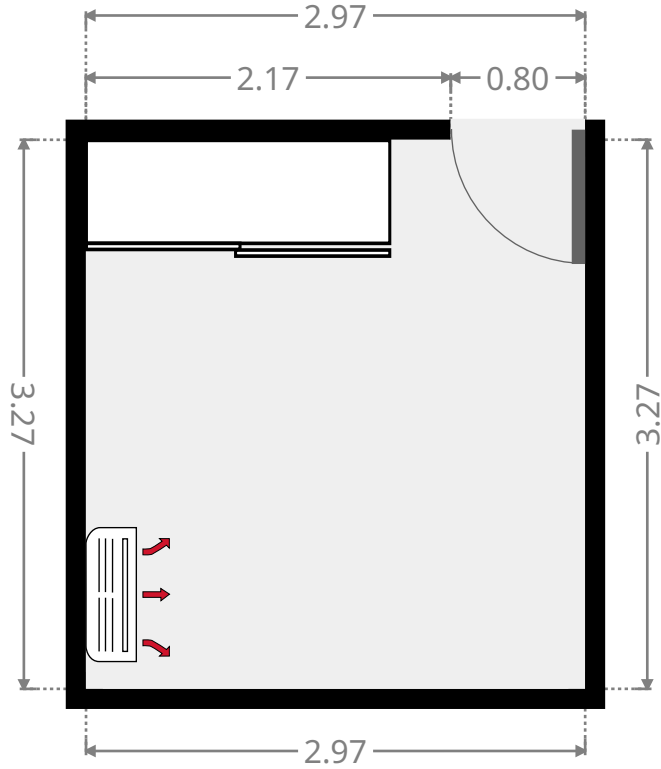
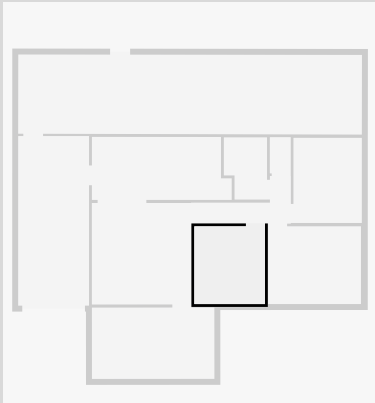

## Bedroom

Width: 3.27 m  
 Length: 3.91 m  
 Area: 12.77 m<sup>2</sup>  
 Perimeter: 14.35 m

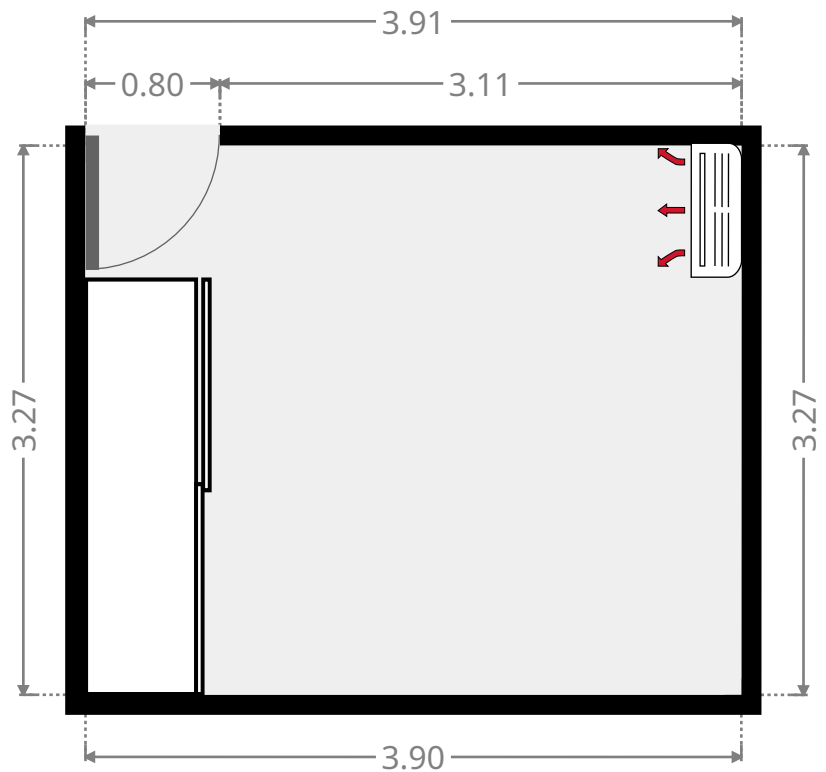
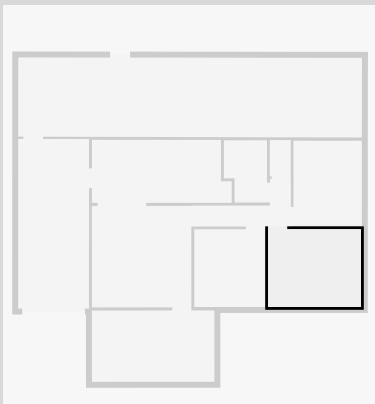

THIS FLOORPLAN IS PROVIDED WITHOUT WARRANTY OF ANY KIND. SENSOPIA DISCLAIMS ANY WARRANTY INCLUDING, WITHOUT LIMITATION, SATISFACTORY QUALITY OR ACCURACY OF DIMENSIONS.

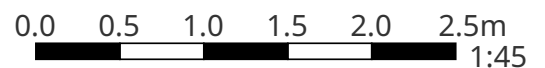

# 379 Lilley Avenue

## Bedroom

Width: 2.88 m  
Length: 3.58 m  
Area: 10.29 m<sup>2</sup>  
Perimeter: 12.91 m

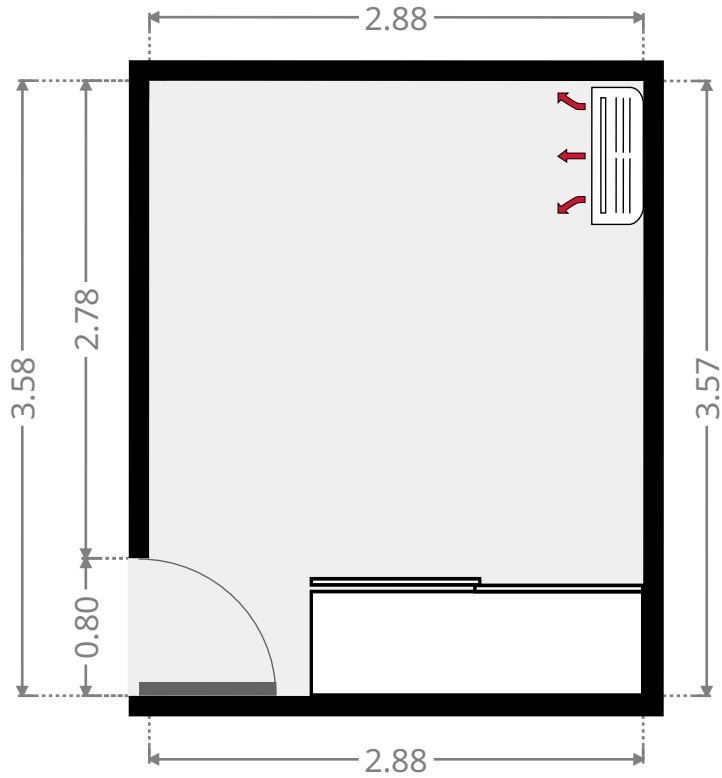
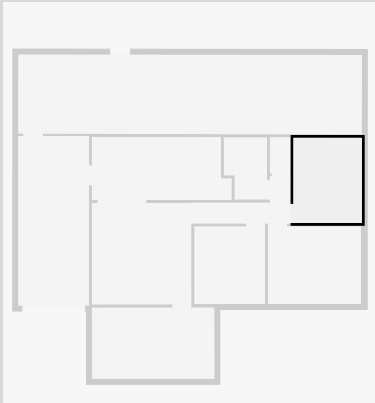

## Toilet / Half Bath

Width: 0.88 m  
Length: 1.52 m  
Area: 1.34 m<sup>2</sup>  
Perimeter: 4.81 m

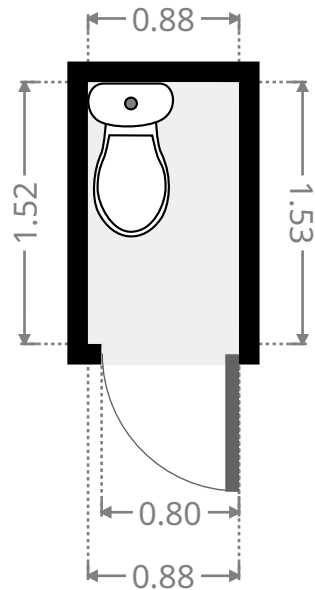
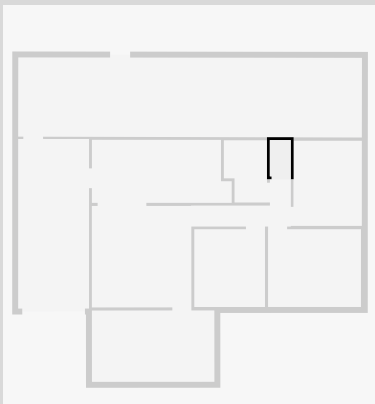

# 379 Lilley Avenue

## Bathroom

Width: 1.82 m  
 Length: 2.62 m  
 Area: 4.29 m<sup>2</sup>  
 Perimeter: 8.86 m

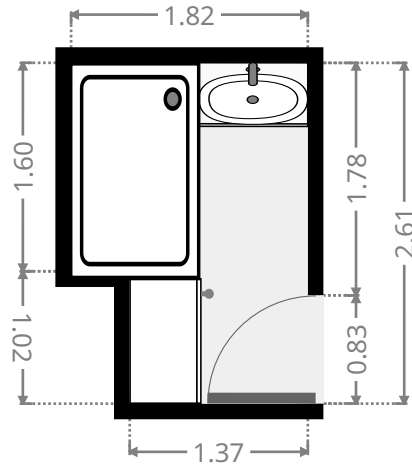
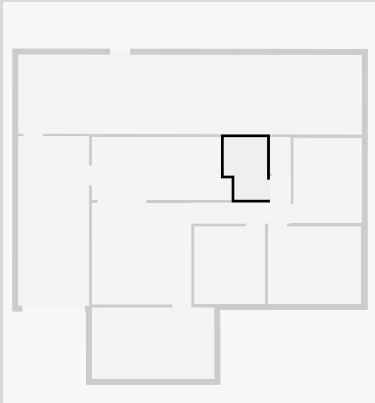

## Kitchen/Dining

Width: 2.65 m  
 Length: 5.88 m  
 Area: 14.79 m<sup>2</sup>  
 Perimeter: 17.06 m

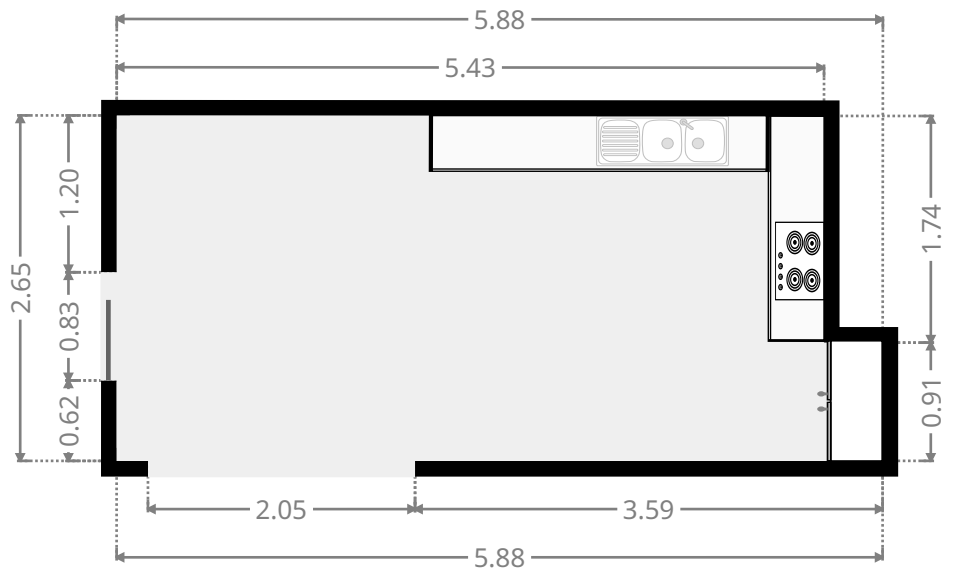
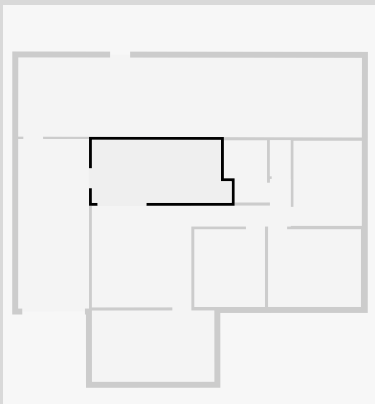

THIS FLOORPLAN IS PROVIDED WITHOUT WARRANTY OF ANY KIND. SENSOPIA DISCLAIMS ANY WARRANTY INCLUDING, WITHOUT LIMITATION, SATISFACTORY QUALITY OR ACCURACY OF DIMENSIONS.

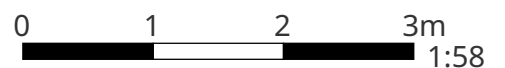

# 379 Lilley Avenue

## Garage

Width: 2.98 m  
 Length: 7.13 m  
 Area: 21.25 m<sup>2</sup>  
 Perimeter: 20.22 m

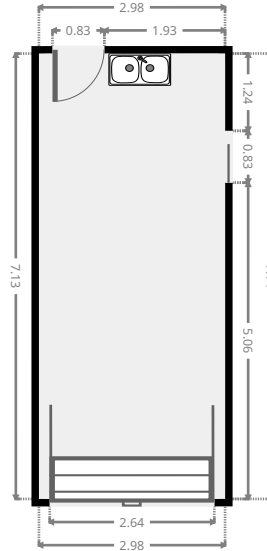
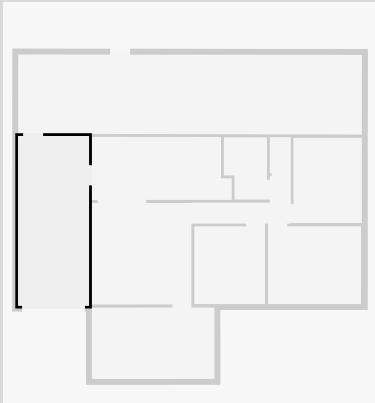

## Outdoor Area

Width: 3.35 m  
 Length: 14.45 m  
 Area: 48.27 m<sup>2</sup>  
 Perimeter: 35.58 m

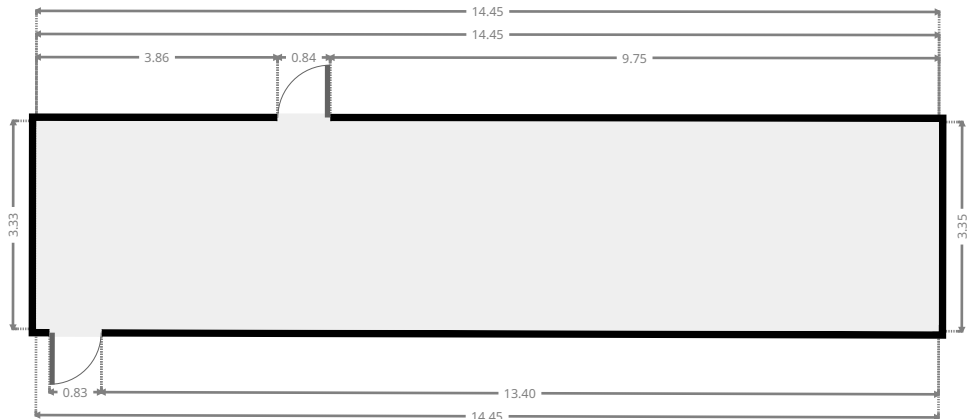
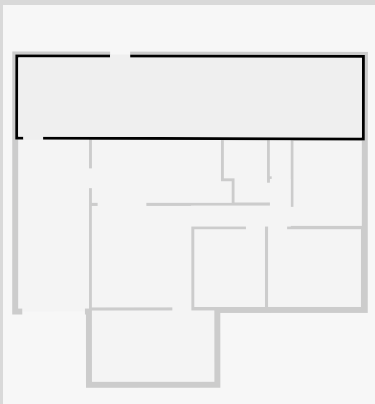

# 379 Lilley Avenue

## Outdoor Area

Width: 3.00 m  
Length: 5.15 m  
Area: 15.44 m<sup>2</sup>  
Perimeter: 16.30 m

