

# 374 Lilley Avenue

## Ground Floor

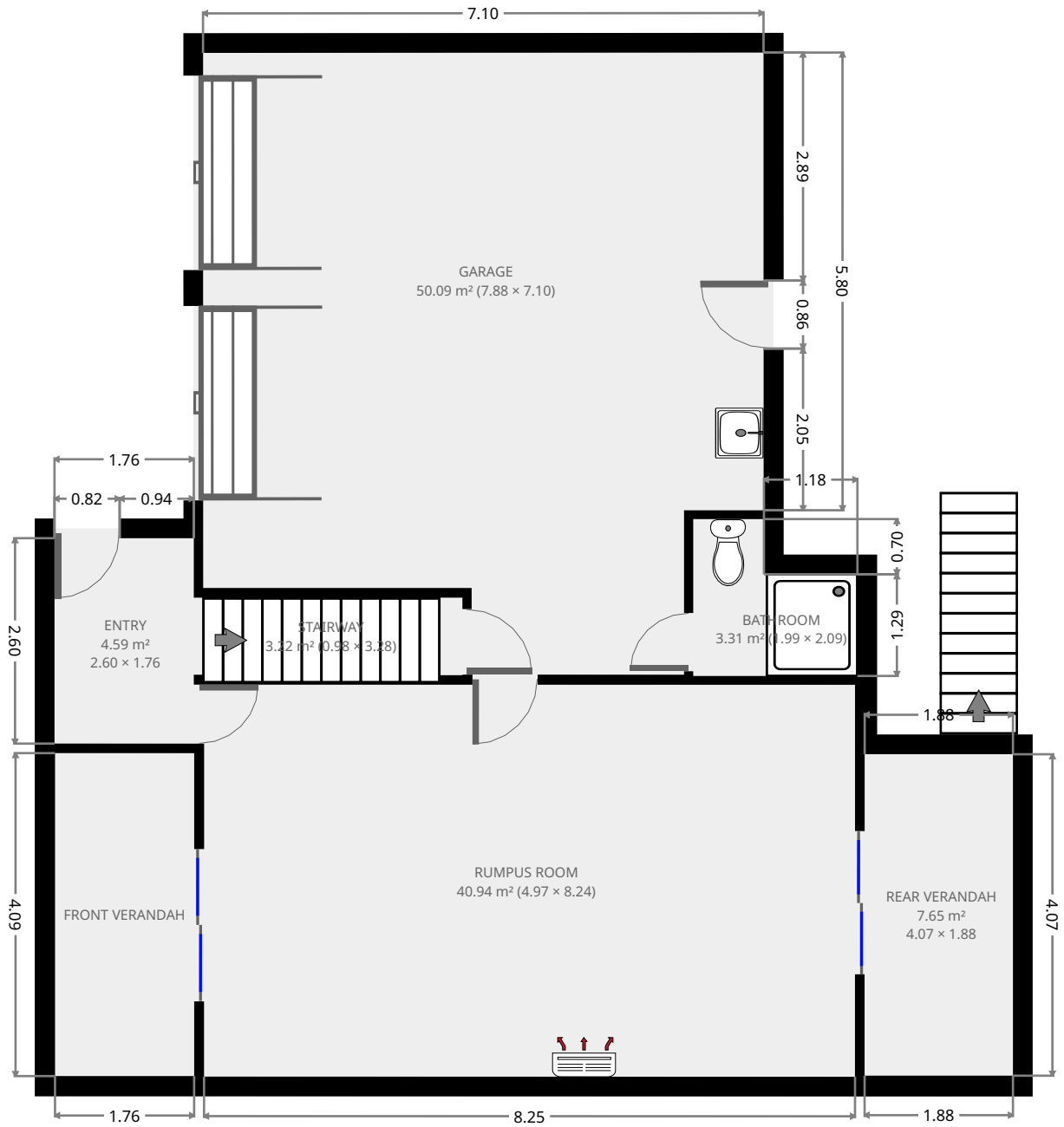

THIS FLOORPLAN IS PROVIDED WITHOUT WARRANTY OF ANY KIND. SENSOPIA DISCLAIMS ANY WARRANTY INCLUDING, WITHOUT LIMITATION, SATISFACTORY QUALITY OR ACCURACY OF DIMENSIONS.



# 374 Lilley Avenue

## Rumpus Room

Width: 4.97 m  
 Length: 8.24 m  
 Area: 40.94 m<sup>2</sup>  
 Perimeter: 26.42 m

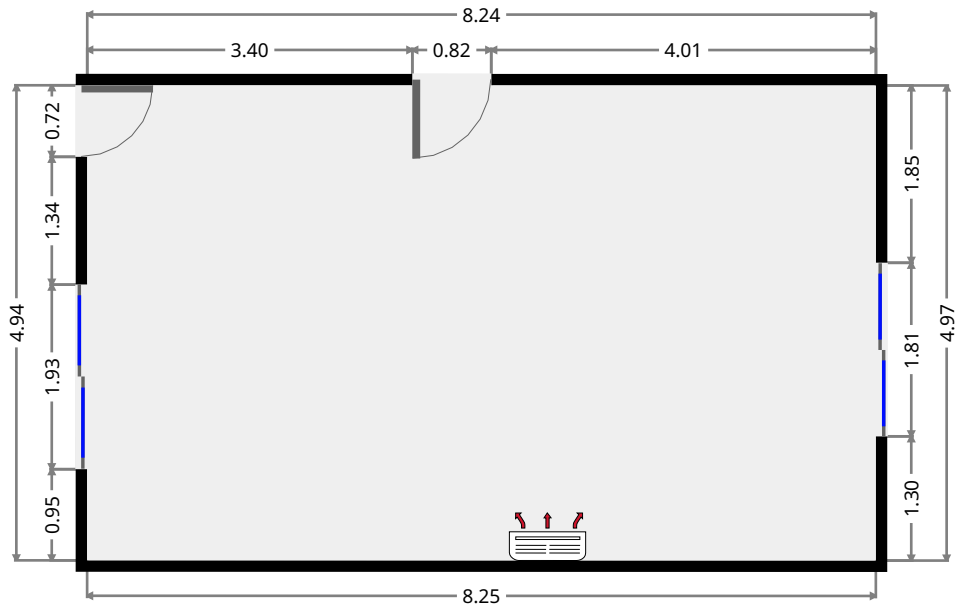
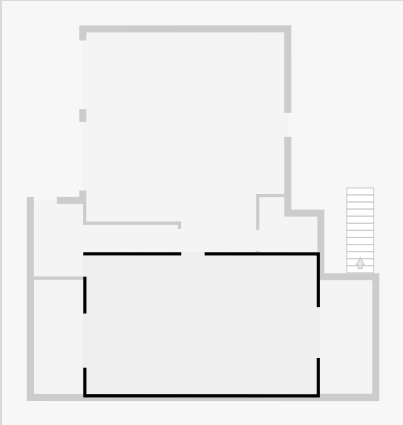

## Entry

Width: 1.76 m  
 Length: 2.60 m  
 Area: 4.59 m<sup>2</sup>  
 Perimeter: 8.73 m

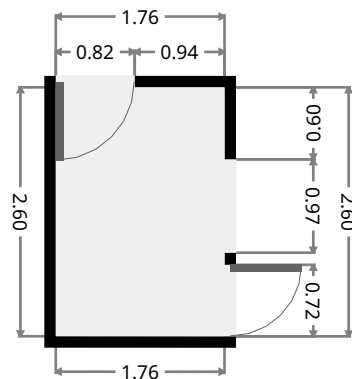
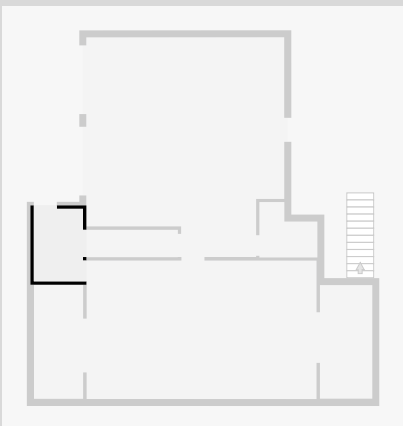

# 374 Lilley Avenue

## Front Verandah

Width: 1.76 m  
Length: 4.09 m  
Area: 7.21 m<sup>2</sup>  
Perimeter: 11.71 m

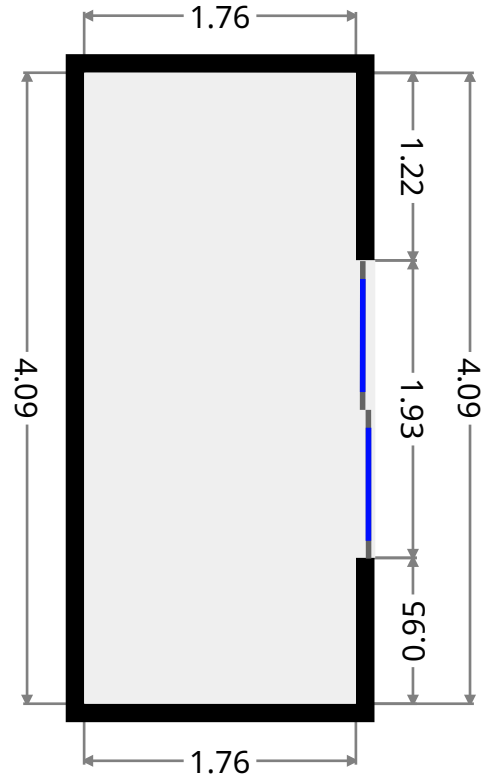
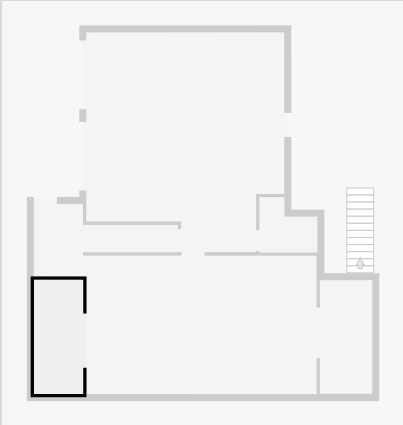

## Rear Verandah

Width: 1.88 m  
Length: 4.07 m  
Area: 7.65 m<sup>2</sup>  
Perimeter: 11.90 m

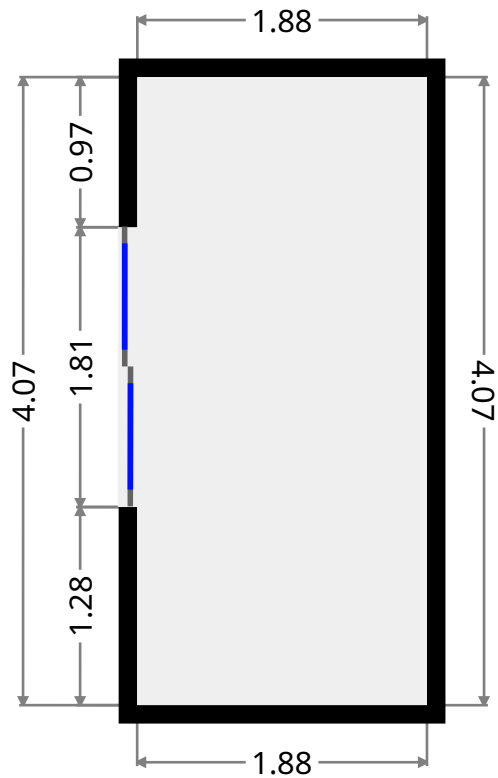
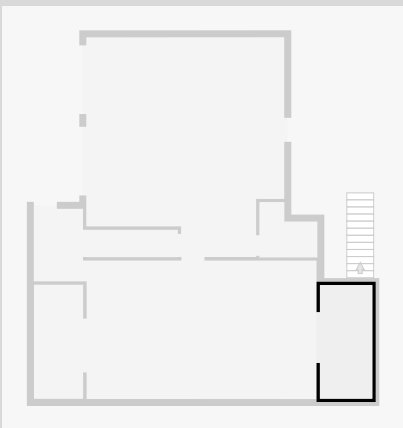

# 374 Lilley Avenue

## Garage

Width: 7.10 m  
 Length: 7.88 m  
 Area: 50.09 m<sup>2</sup>  
 Perimeter: 29.96 m

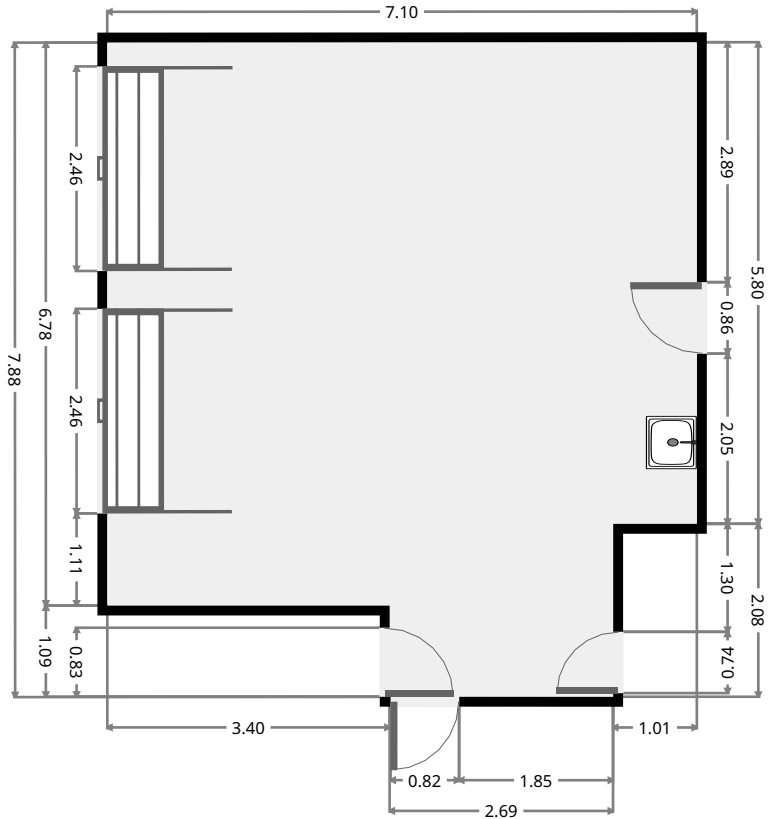
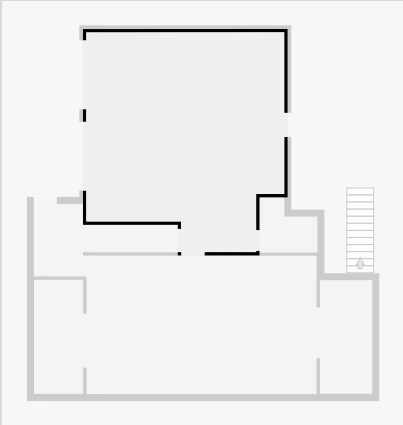

## Stairway

Width: 0.98 m  
 Length: 3.28 m  
 Area: 3.22 m<sup>2</sup>  
 Perimeter: 8.52 m

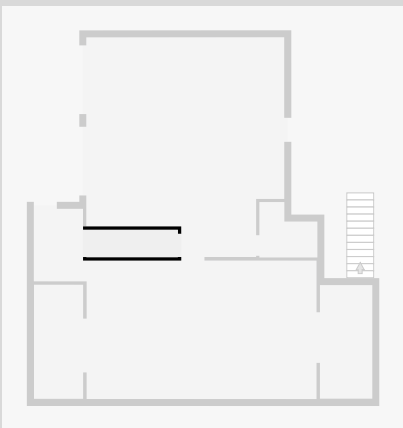

THIS FLOORPLAN IS PROVIDED WITHOUT WARRANTY OF ANY KIND. SENSOPIA DISCLAIMS ANY WARRANTY INCLUDING, WITHOUT LIMITATION, SATISFACTORY QUALITY OR ACCURACY OF DIMENSIONS.

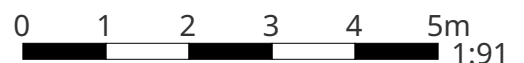

# 374 Lilley Avenue

## Bathroom

Width: 1.99 m  
Length: 2.09 m  
Area: 3.31 m<sup>2</sup>  
Perimeter: 8.13 m

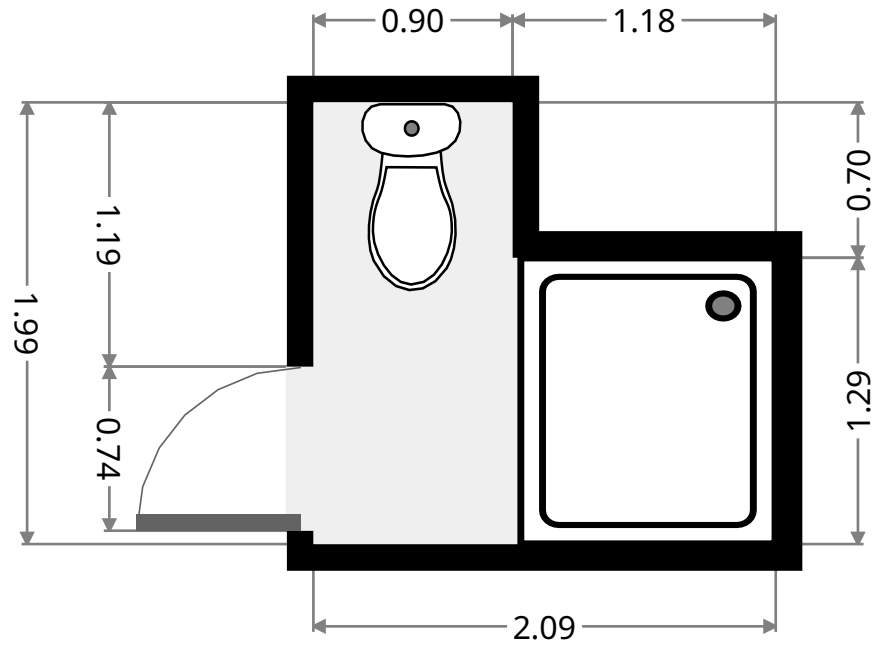
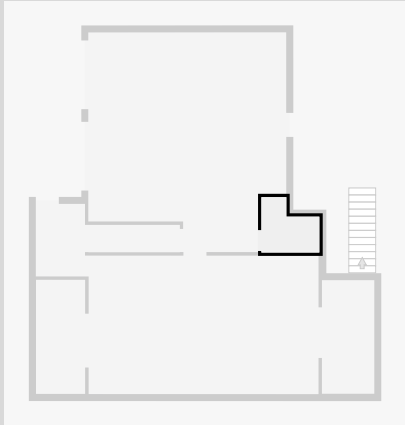

# 374 Lilley Avenue

## 1st Floor

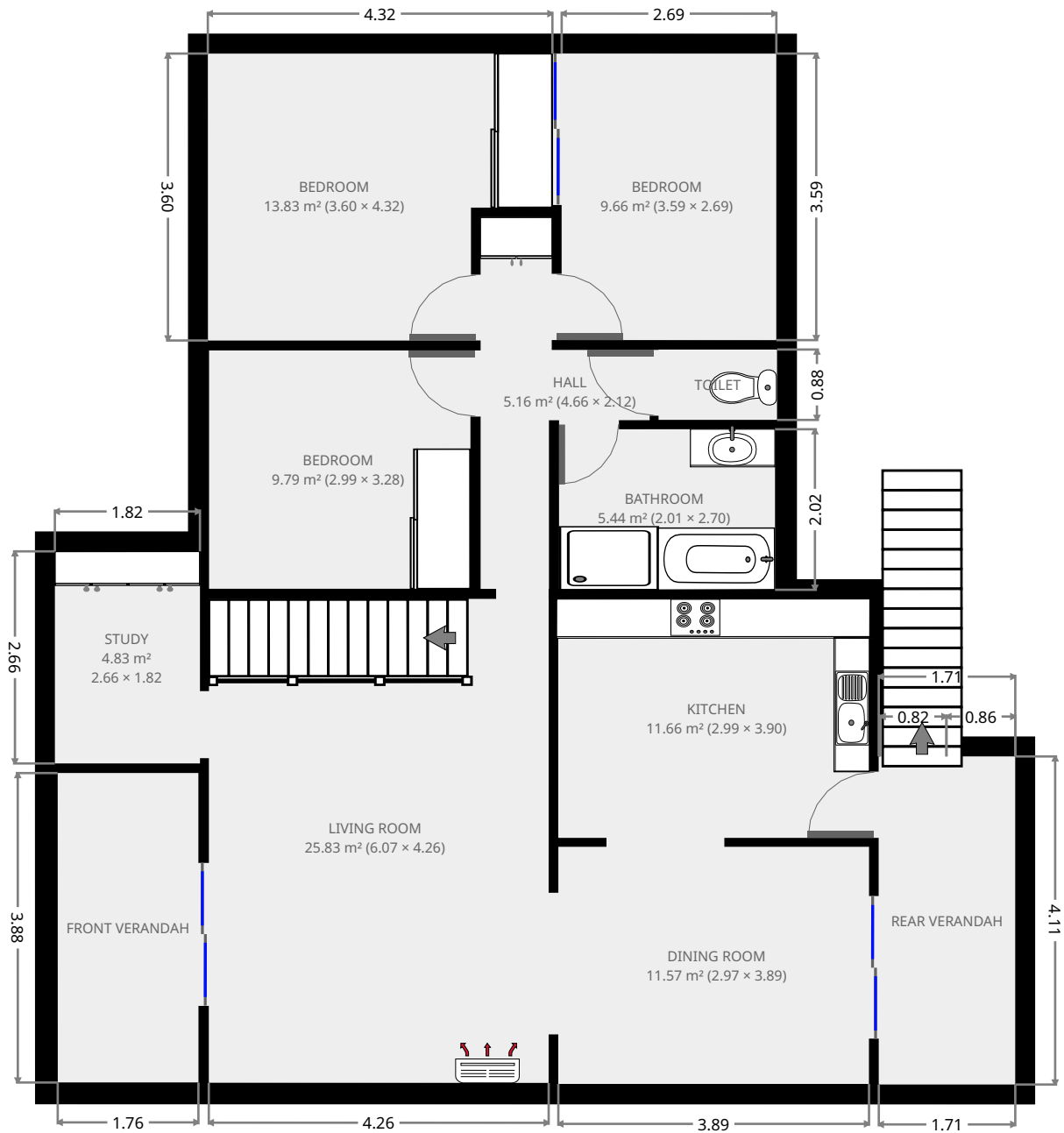

THIS FLOORPLAN IS PROVIDED WITHOUT WARRANTY OF ANY KIND. SENSOPIA DISCLAIMS ANY WARRANTY INCLUDING, WITHOUT LIMITATION, SATISFACTORY QUALITY OR ACCURACY OF DIMENSIONS.



# 374 Lilley Avenue

## Living Room

Width: 4.26 m  
Length: 6.07 m  
Area: 25.83 m<sup>2</sup>  
Perimeter: 20.65 m

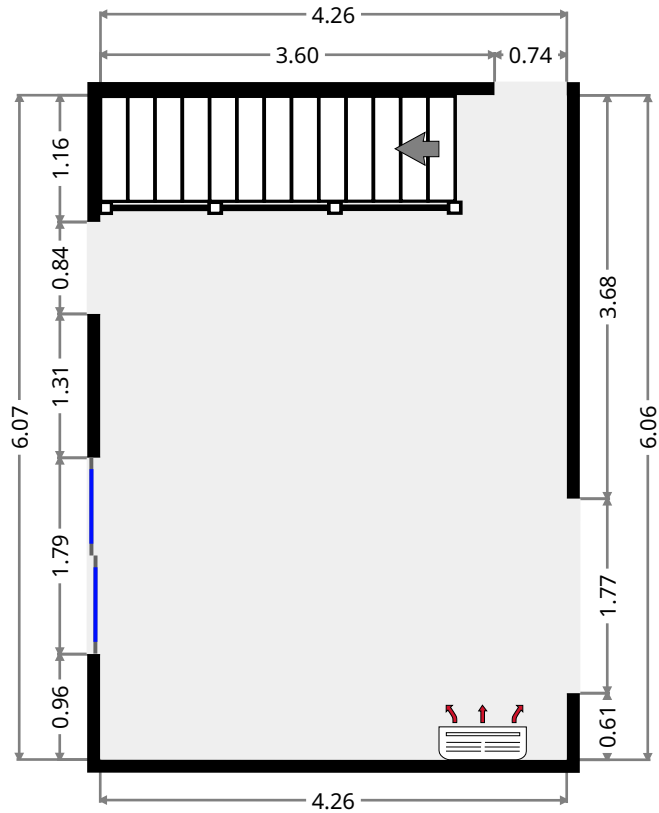
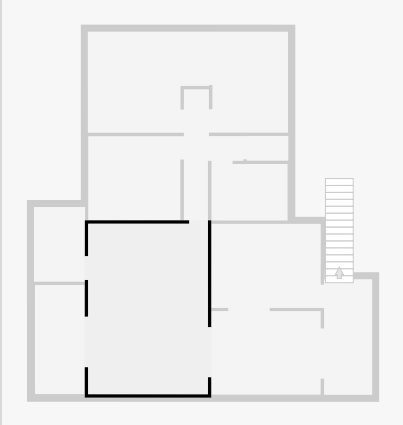

## Study

Width: 1.82 m  
Length: 2.66 m  
Area: 4.83 m<sup>2</sup>  
Perimeter: 8.95 m

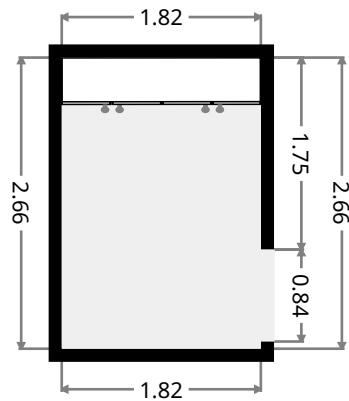
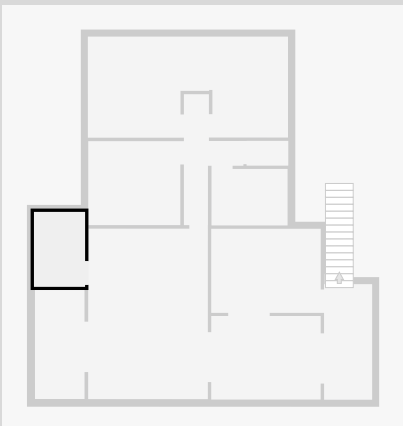

# 374 Lilley Avenue

## Front Verandah

Width: 1.76 m  
 Length: 3.88 m  
 Area: 6.84 m<sup>2</sup>  
 Perimeter: 11.28 m

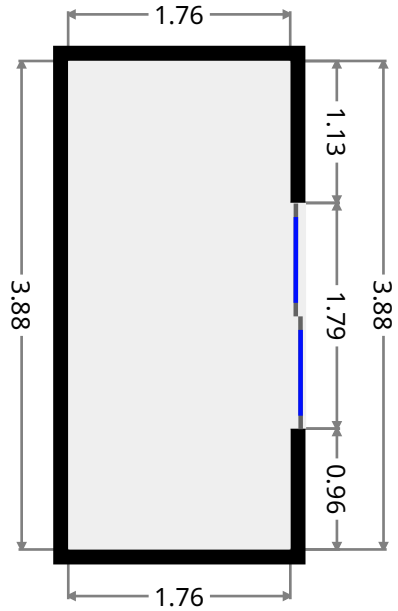
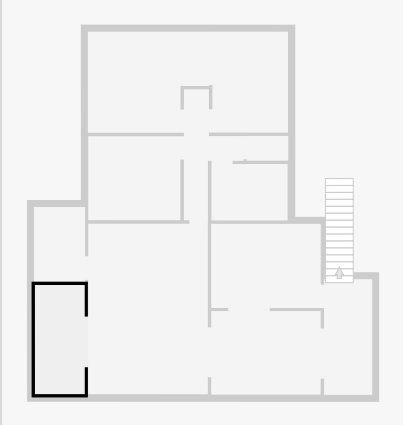

## Hall

Width: 2.12 m  
 Length: 4.66 m  
 Area: 5.16 m<sup>2</sup>  
 Perimeter: 13.56 m

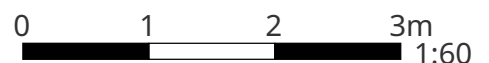
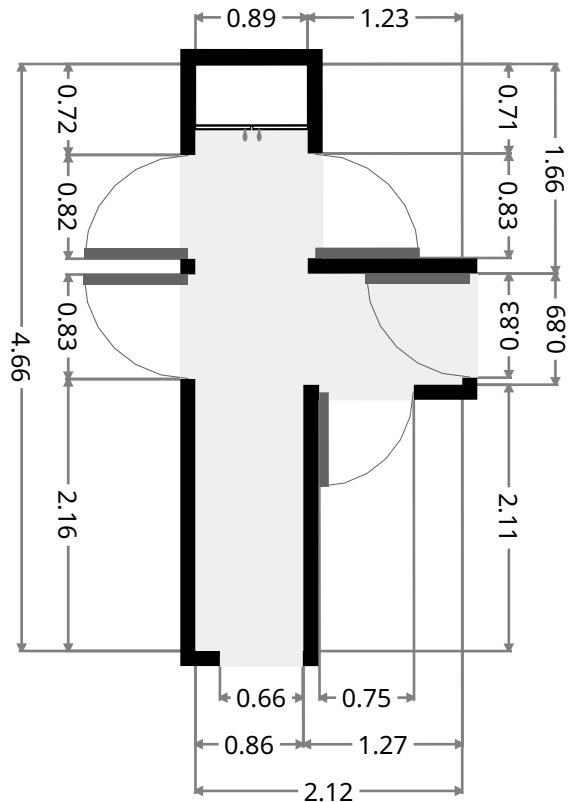
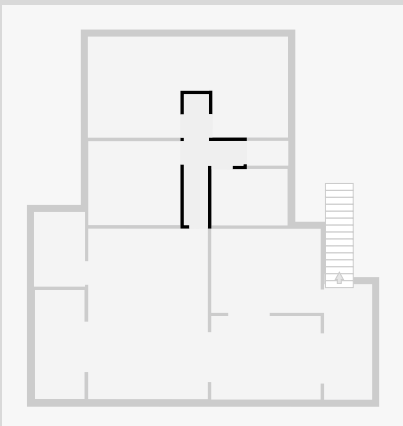

THIS FLOORPLAN IS PROVIDED WITHOUT WARRANTY OF ANY KIND. SENSOPIA DISCLAIMS ANY WARRANTY INCLUDING, WITHOUT LIMITATION, SATISFACTORY QUALITY OR ACCURACY OF DIMENSIONS.



# 374 Lilley Avenue

## Bedroom

Width: 2.99 m  
 Length: 3.28 m  
 Area: 9.79 m<sup>2</sup>  
 Perimeter: 12.53 m

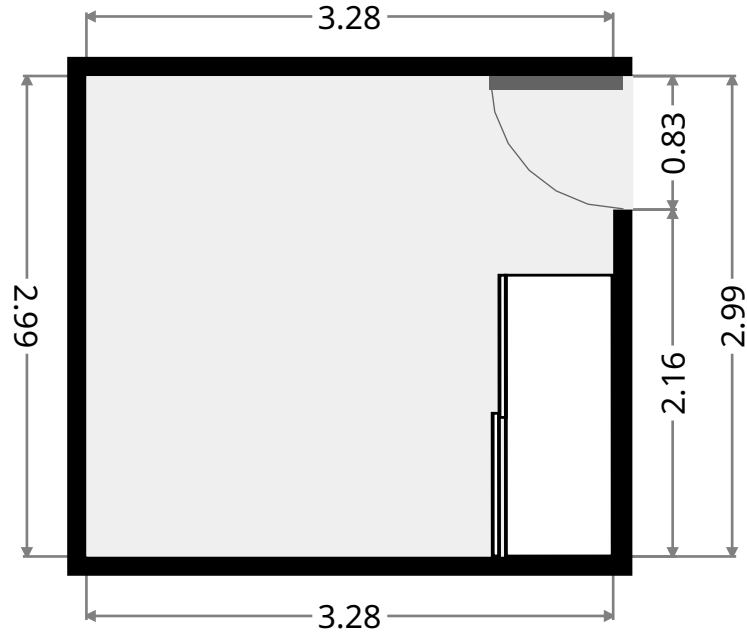
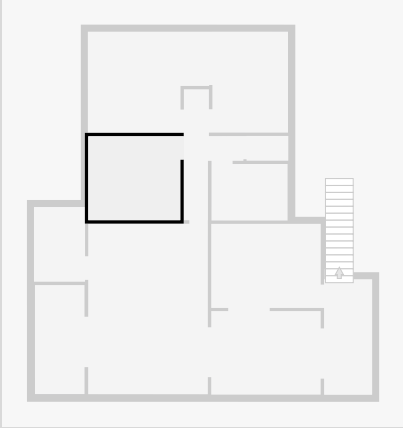

## Bedroom

Width: 3.60 m  
 Length: 4.32 m  
 Area: 13.83 m<sup>2</sup>  
 Perimeter: 15.83 m

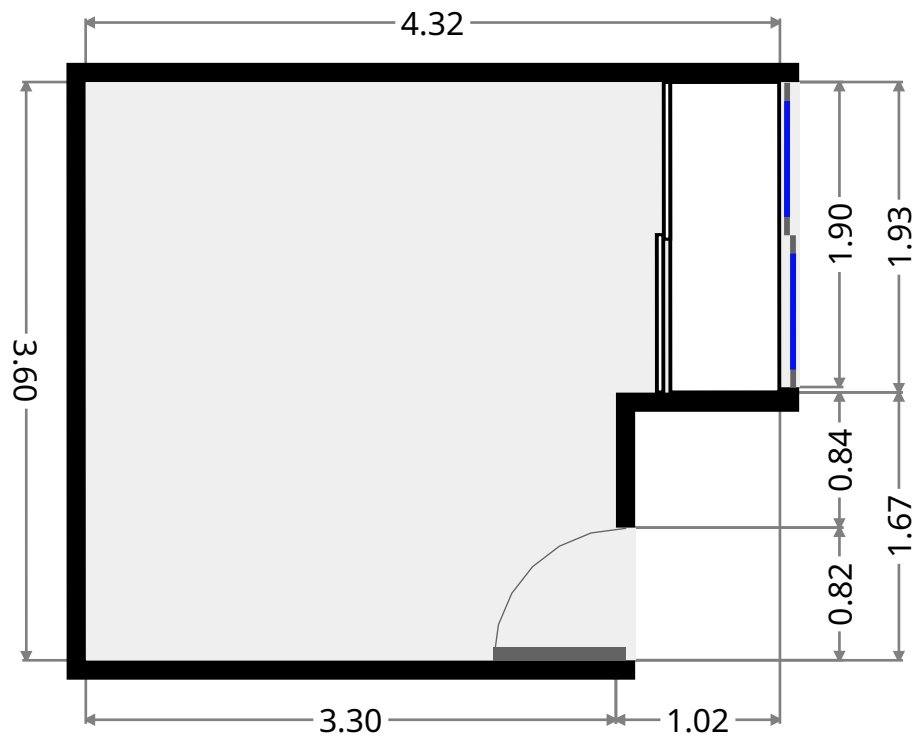
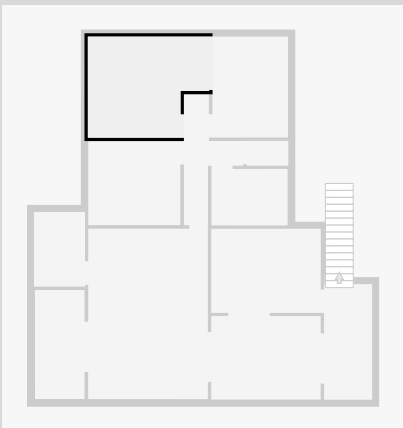

THIS FLOORPLAN IS PROVIDED WITHOUT WARRANTY OF ANY KIND. SENSOPIA DISCLAIMS ANY WARRANTY INCLUDING, WITHOUT LIMITATION, SATISFACTORY QUALITY OR ACCURACY OF DIMENSIONS.

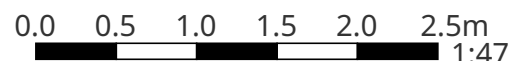

# 374 Lilley Avenue

## Bedroom

Width: 2.69 m  
Length: 3.59 m  
Area: 9.66 m<sup>2</sup>  
Perimeter: 12.56 m

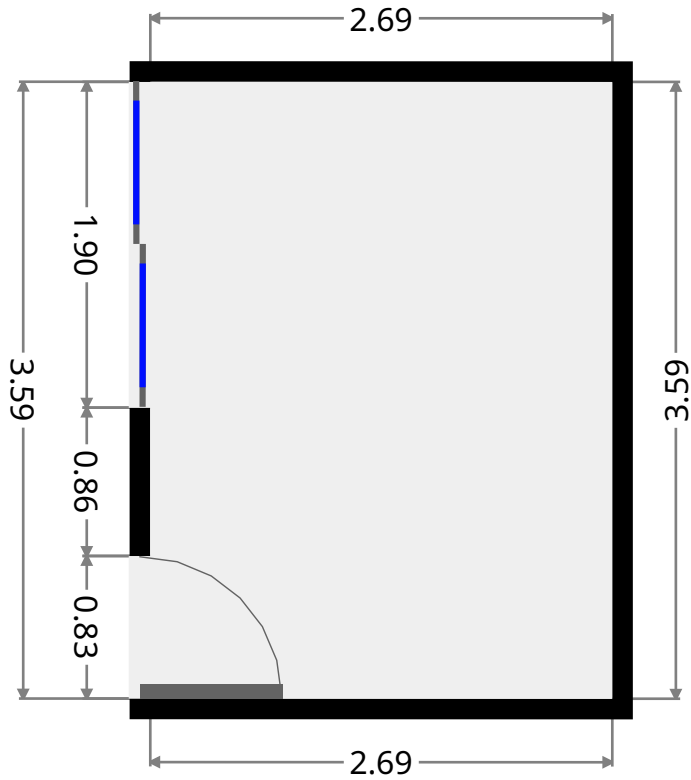
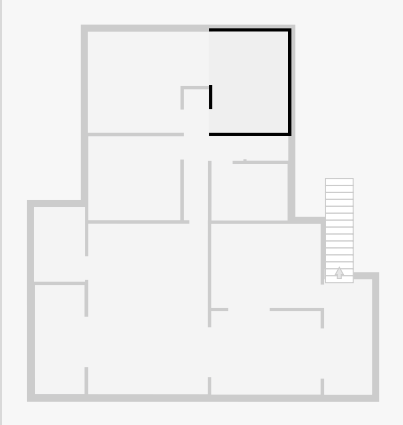

## Toilet

Width: 0.88 m  
Length: 1.49 m  
Area: 1.31 m<sup>2</sup>  
Perimeter: 4.73 m

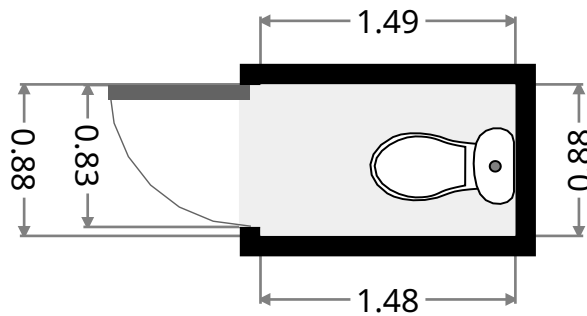
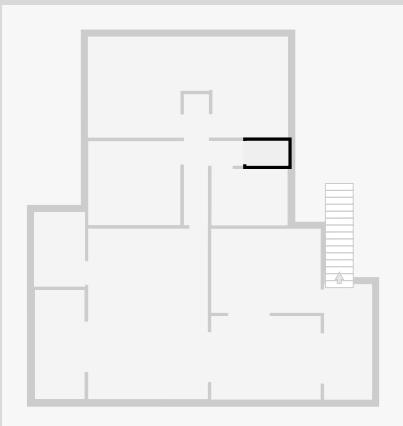

# 374 Lilley Avenue

## Bathroom

Width: 2.01 m  
 Length: 2.70 m  
 Area: 5.44 m<sup>2</sup>  
 Perimeter: 9.44 m

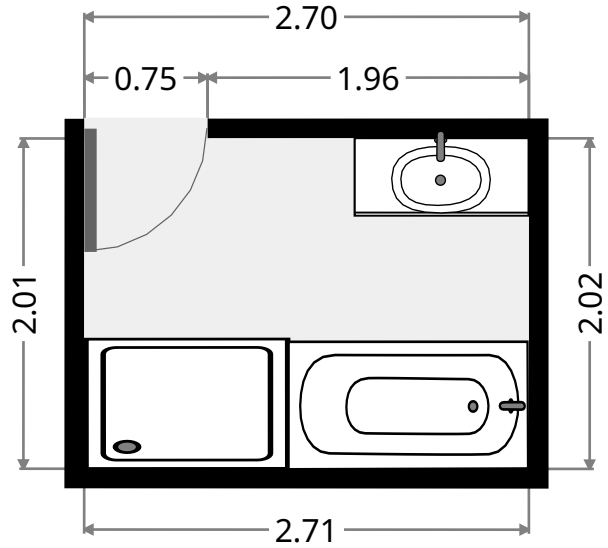
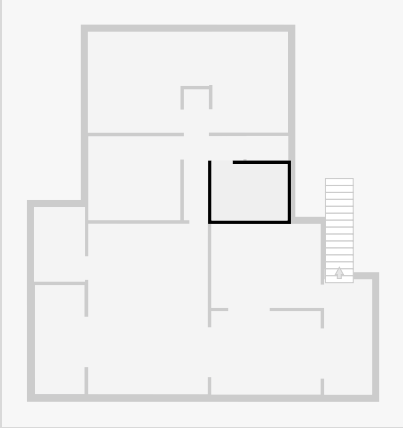

## Dining Room

Width: 2.97 m  
 Length: 3.89 m  
 Area: 11.57 m<sup>2</sup>  
 Perimeter: 13.73 m

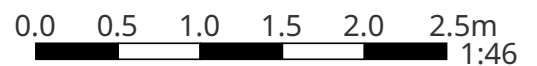
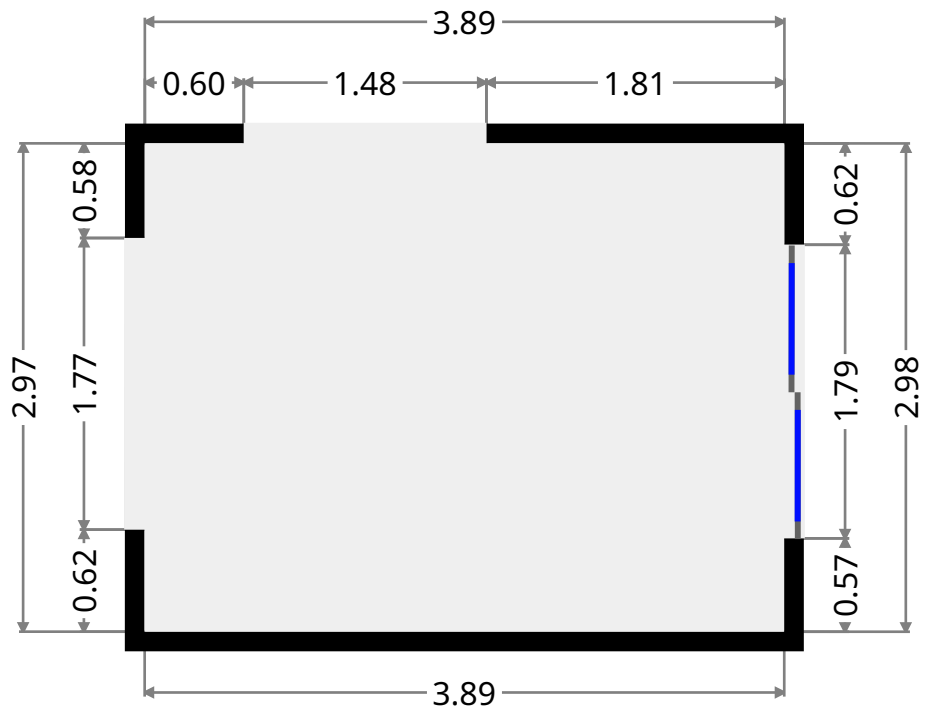
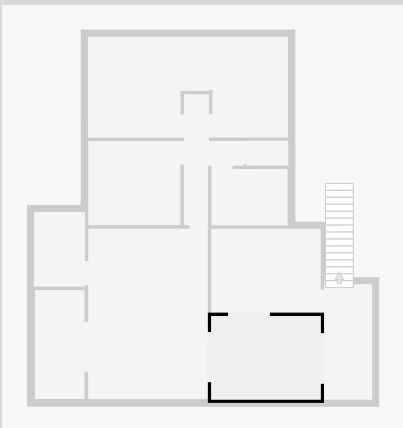

THIS FLOORPLAN IS PROVIDED WITHOUT WARRANTY OF ANY KIND. SENSOPIA DISCLAIMS ANY WARRANTY INCLUDING, WITHOUT LIMITATION, SATISFACTORY QUALITY OR ACCURACY OF DIMENSIONS.

# 374 Lilley Avenue

## Kitchen

Width: 2.99 m  
 Length: 3.90 m  
 Area: 11.66 m<sup>2</sup>  
 Perimeter: 13.78 m

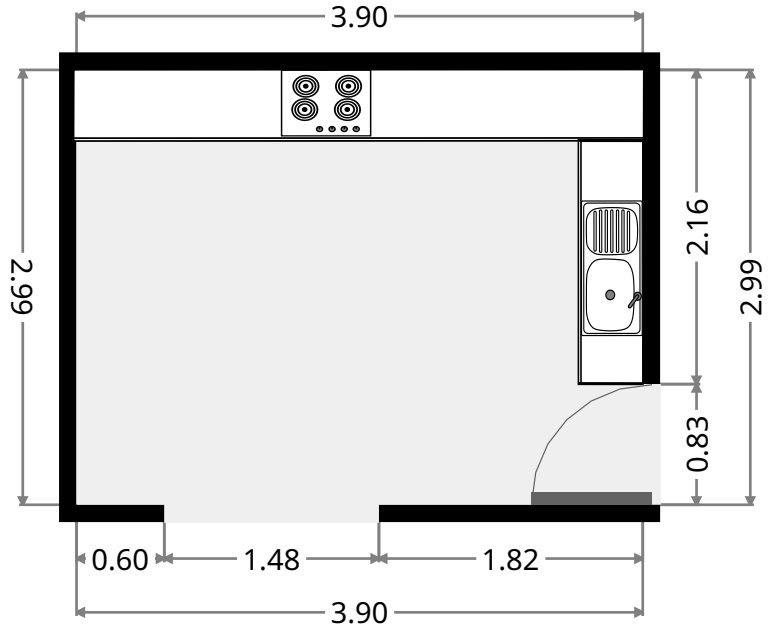
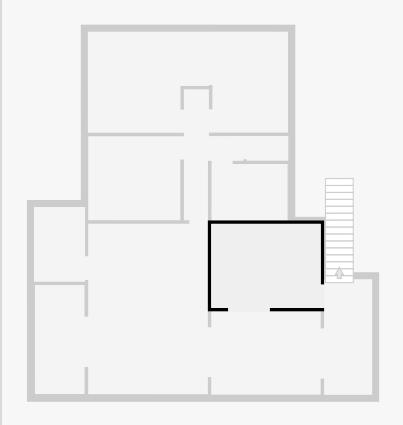

## Rear Verandah

Width: 1.71 m  
 Length: 4.11 m  
 Area: 7.03 m<sup>2</sup>  
 Perimeter: 11.65 m

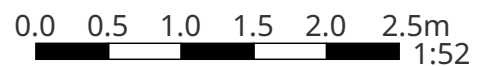
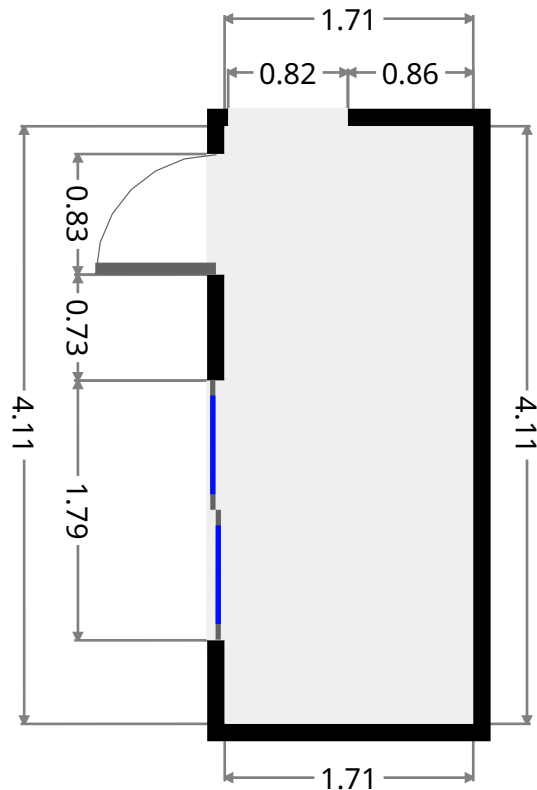
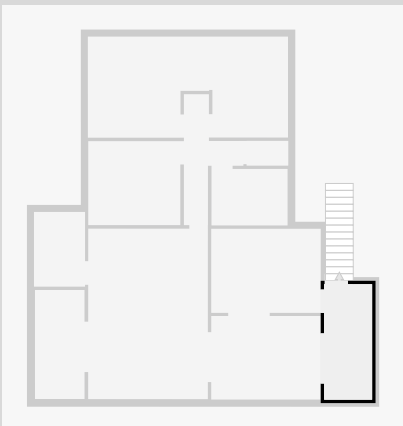

THIS FLOORPLAN IS PROVIDED WITHOUT WARRANTY OF ANY KIND. SENSOPIA DISCLAIMS ANY WARRANTY INCLUDING, WITHOUT LIMITATION, SATISFACTORY QUALITY OR ACCURACY OF DIMENSIONS.