

372 Philp Av

SUBMITTED BY

Ray White Rockhampton Casey
stockers@cqoz.com

CREATED ON

2022-11-30

Floors

2

▼ Ground Floor

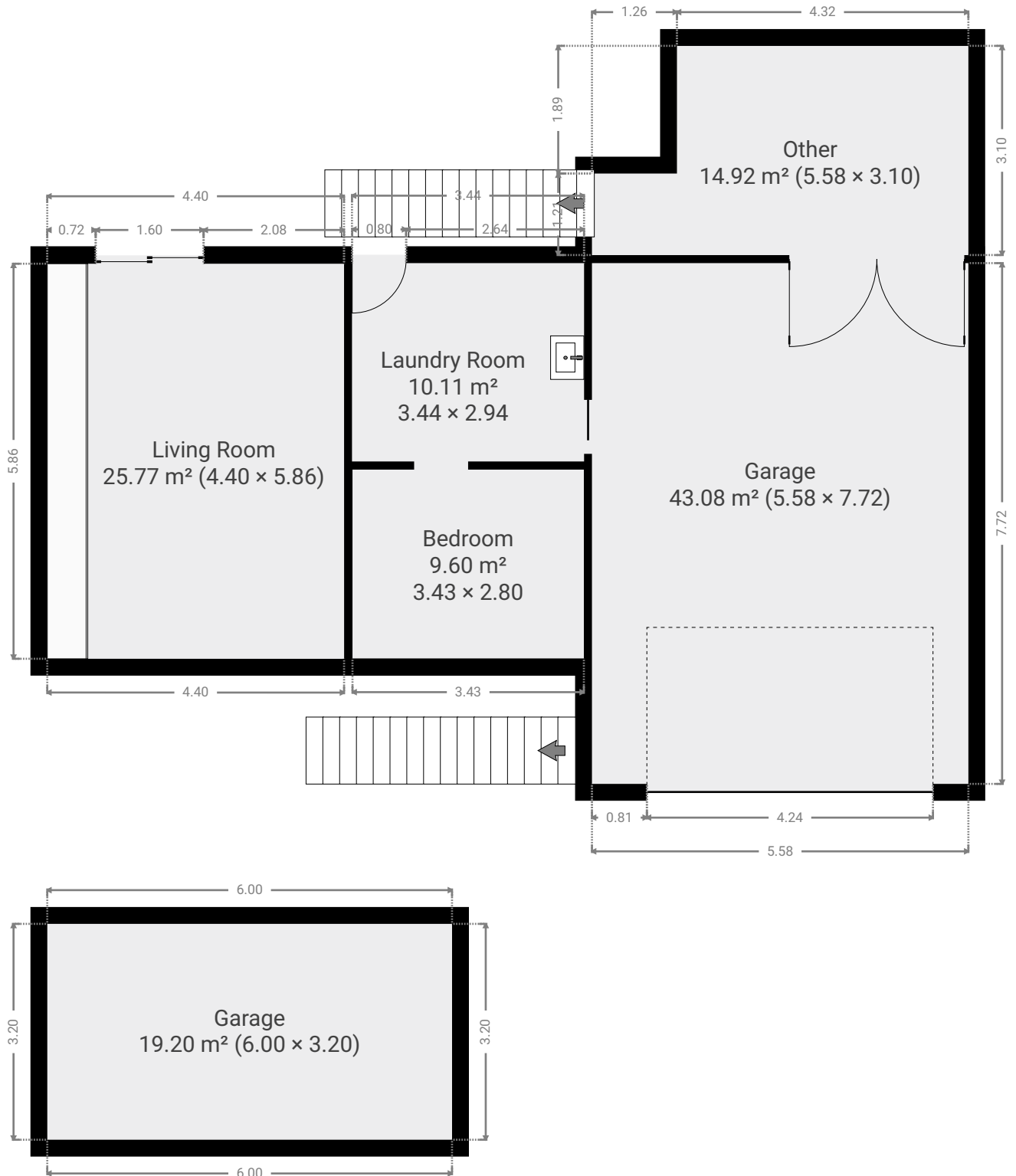

▼ **Bedroom**
Ground Floor

WIDTH: 3.43 m • LENGTH: 2.80 m
AREA: 9.60 m² • PERIMETER: 12.46 m

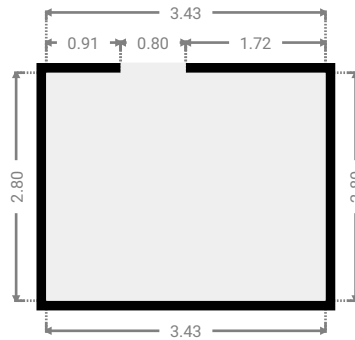
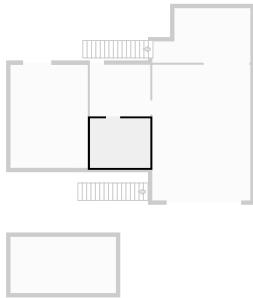

▼ **Garage**
Ground Floor

WIDTH: 5.58 m • LENGTH: 7.72 m
AREA: 43.08 m² • PERIMETER: 26.60 m

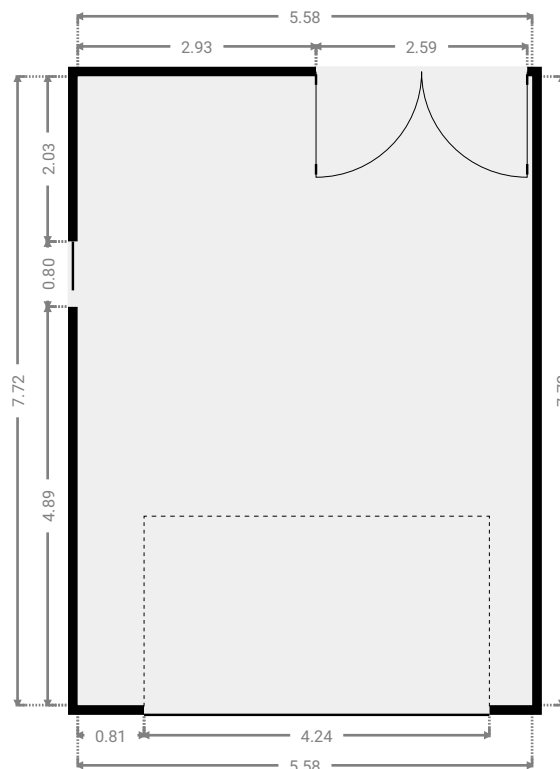
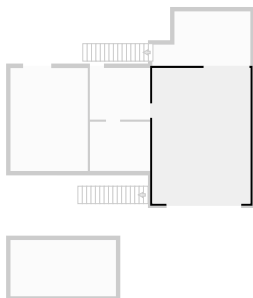

▼ **Garage**
Ground Floor

WIDTH: 6.00 m • LENGTH: 3.20 m
AREA: 19.20 m² • PERIMETER: 18.40 m

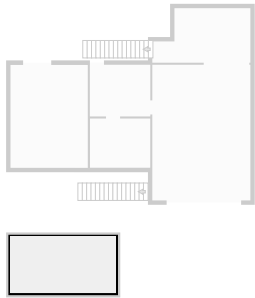

▼ **Laundry Room**
Ground Floor

WIDTH: 3.44 m • LENGTH: 2.94 m
AREA: 10.11 m² • PERIMETER: 12.76 m

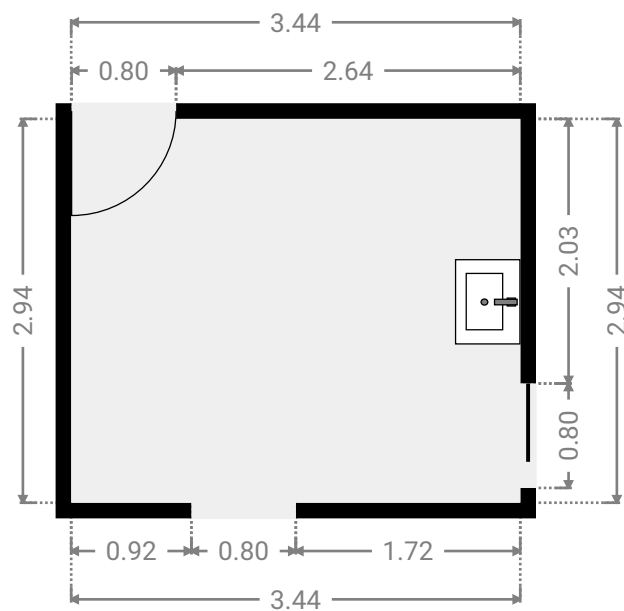
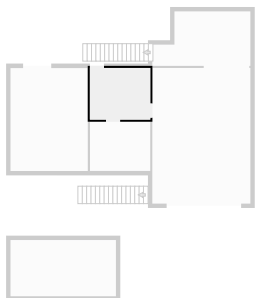

▼ **Living Room**
Ground Floor

WIDTH: 4.40 m • LENGTH: 5.86 m
AREA: 25.77 m² • PERIMETER: 20.51 m

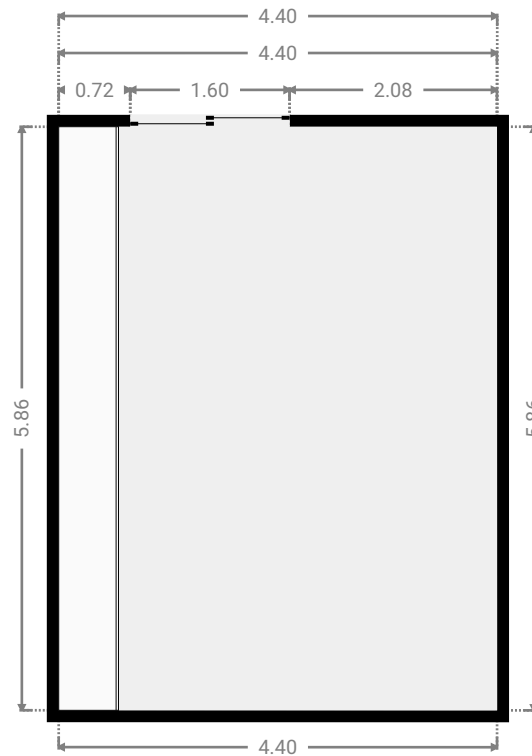
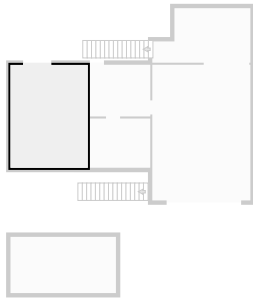

▼ **Other**
Ground Floor

WIDTH: 5.58 m • LENGTH: 3.10 m
AREA: 14.92 m² • PERIMETER: 17.36 m

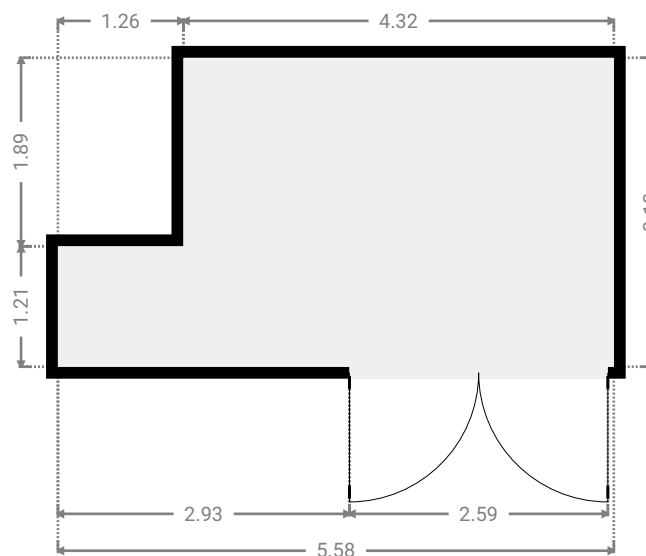
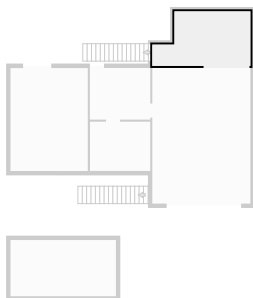

▼ 1st Floor

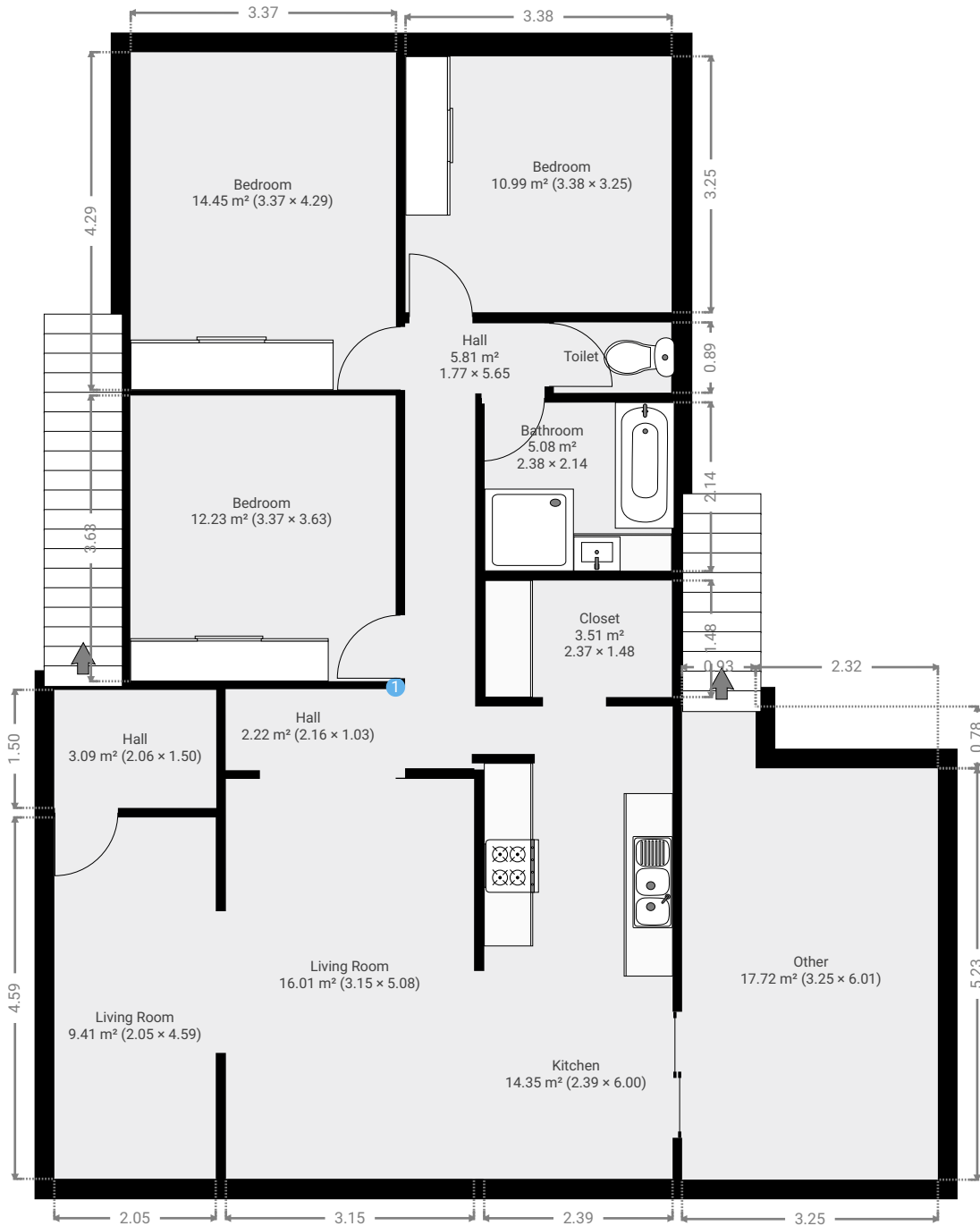

▼ **Bathroom**
1st Floor

WIDTH: 2.14 m • LENGTH: 2.38 m
AREA: 5.08 m² • PERIMETER: 9.03 m

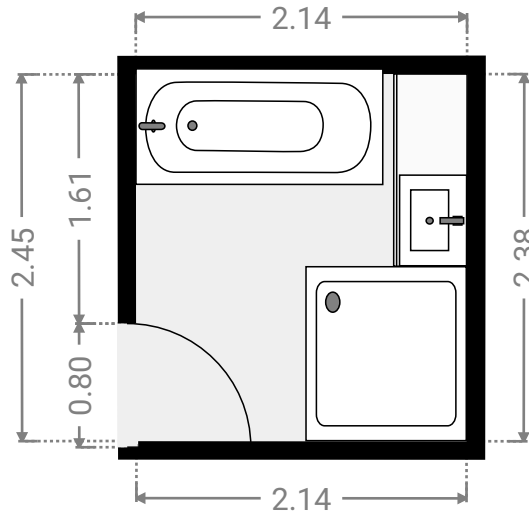
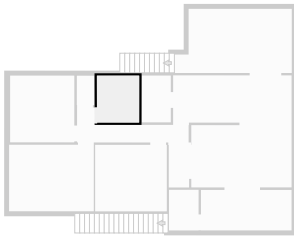

▼ **Bedroom**
1st Floor

WIDTH: 3.63 m • LENGTH: 3.37 m
AREA: 12.23 m² • PERIMETER: 14.00 m

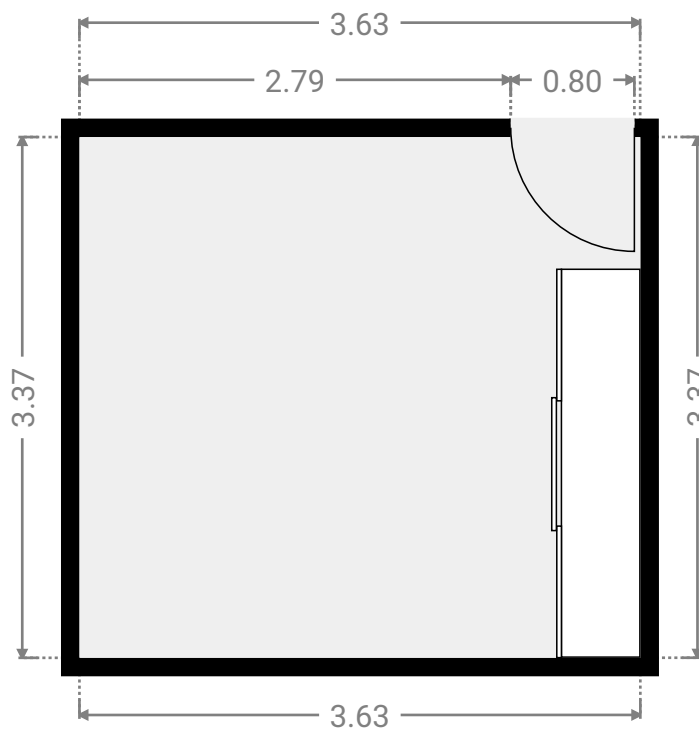
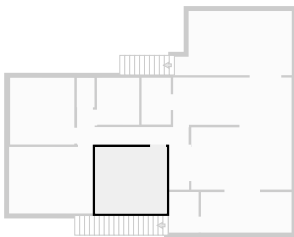

▼ **Bedroom**
1st Floor

WIDTH: 4.29 m • LENGTH: 3.37 m
AREA: 14.45 m² • PERIMETER: 15.32 m

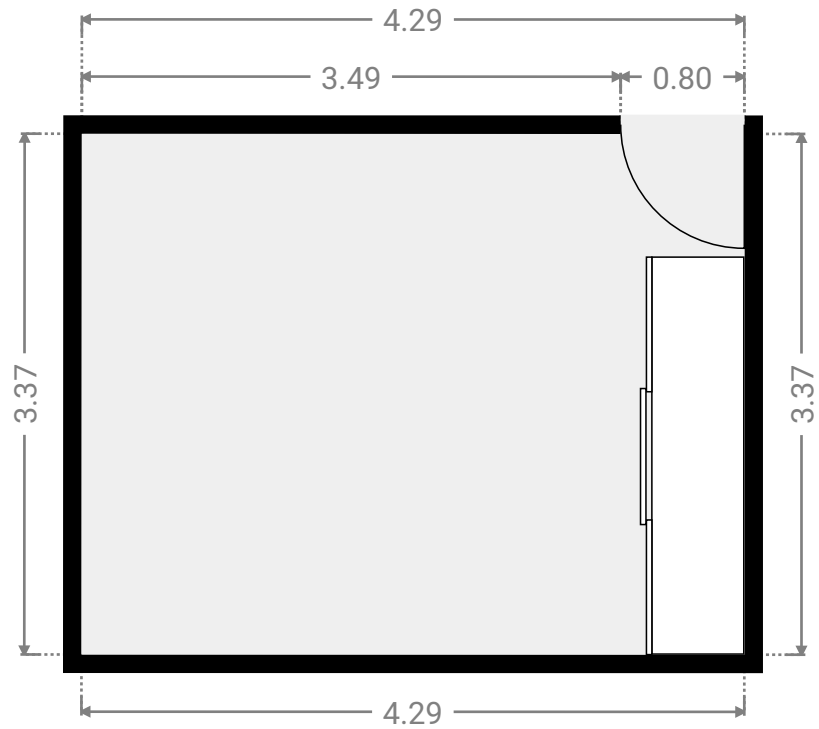
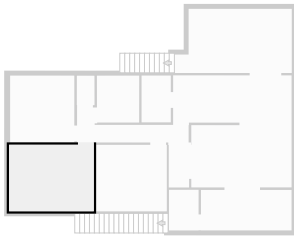

▼ **Bedroom**
1st Floor

WIDTH: 3.25 m • LENGTH: 3.38 m
AREA: 10.99 m² • PERIMETER: 13.26 m

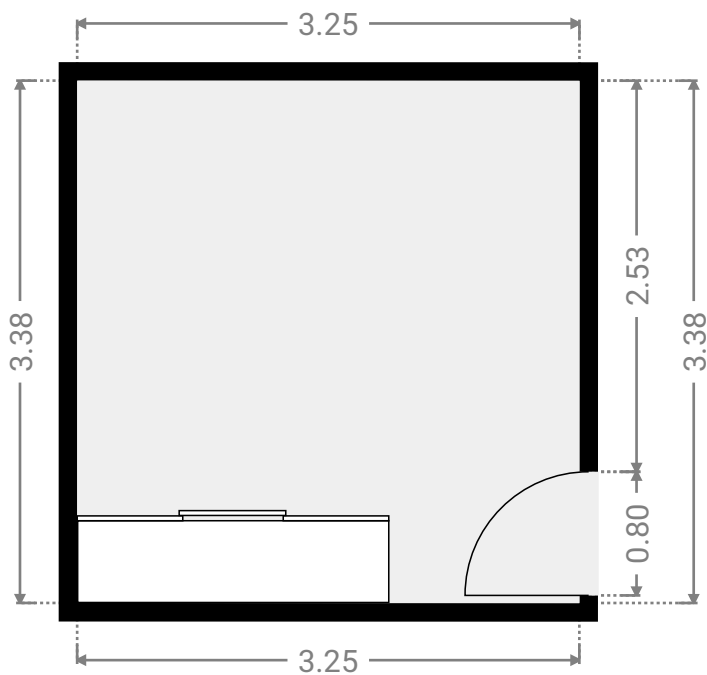
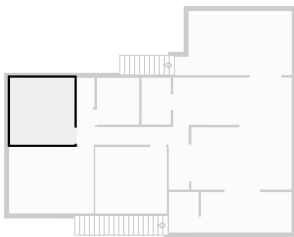

▼ **Hall**
1st Floor

WIDTH: 1.03 m • LENGTH: 2.16 m
AREA: 2.22 m² • PERIMETER: 6.38 m

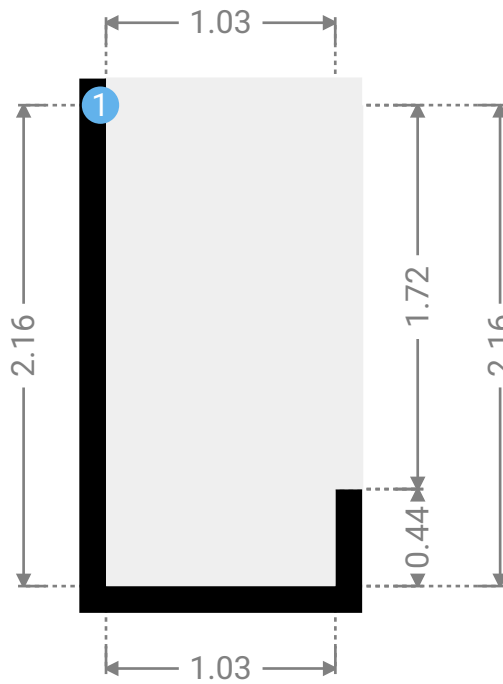
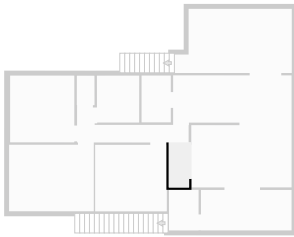

▼ **Hall/1st Floor**

1 OPENING

Height
0.00 m



▼ **Hall**
1st Floor

WIDTH: 5.65 m • LENGTH: 1.77 m
AREA: 5.81 m² • PERIMETER: 14.84 m

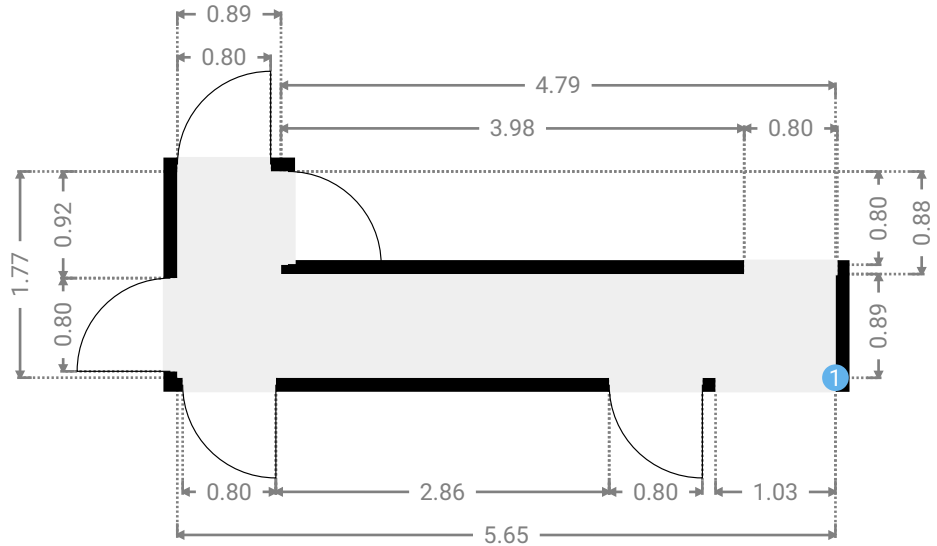
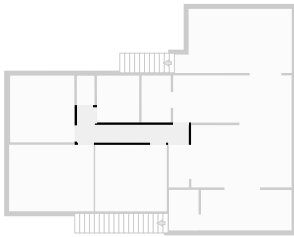

▼ **Hall**
1st Floor

WIDTH: 1.50 m • LENGTH: 2.06 m
AREA: 3.09 m² • PERIMETER: 7.11 m

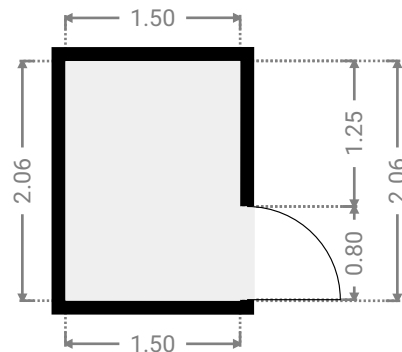
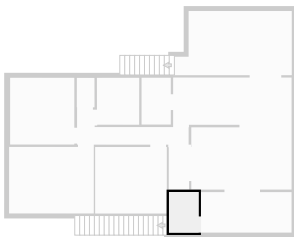

▼ **Kitchen**
1st Floor

WIDTH: 6.00 m • LENGTH: 2.39 m
AREA: 14.35 m² • PERIMETER: 16.78 m

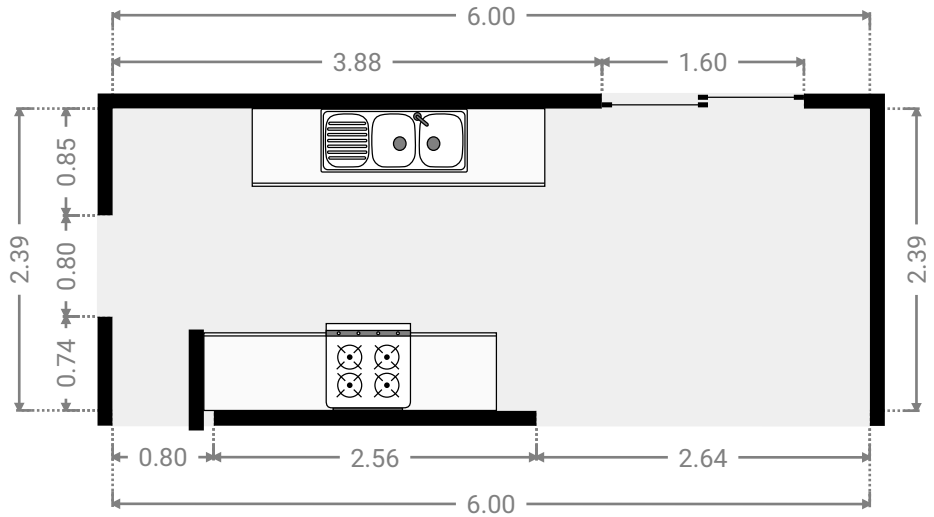
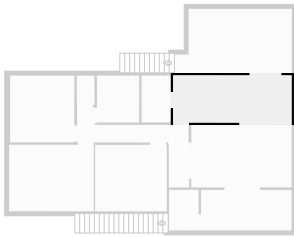

▼ **Closet**
1st Floor

WIDTH: 1.48 m • LENGTH: 2.37 m
AREA: 3.51 m² • PERIMETER: 7.70 m

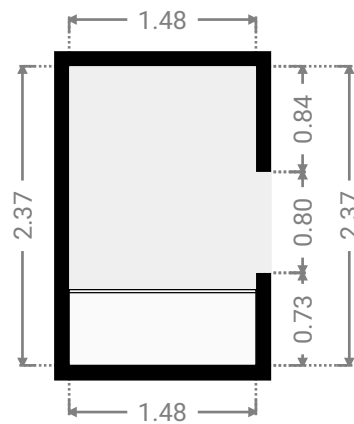
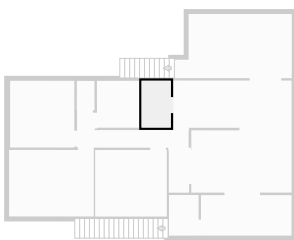

▼ **Living Room**
1st Floor

WIDTH: 4.59 m • LENGTH: 2.05 m
AREA: 9.41 m² • PERIMETER: 13.28 m

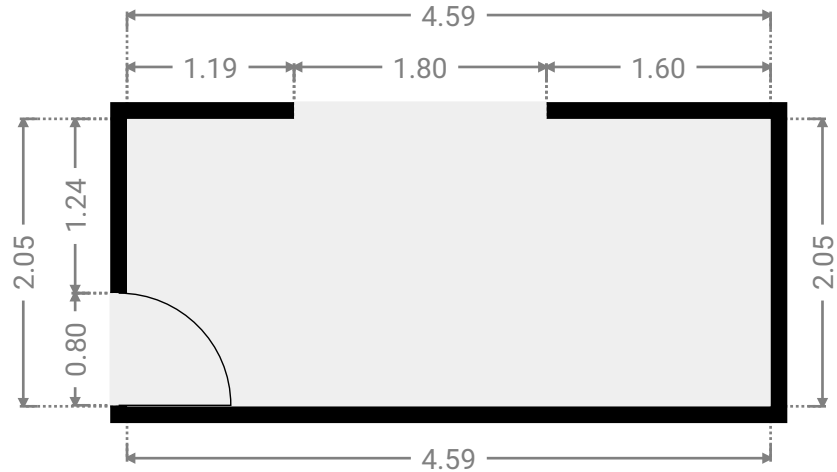
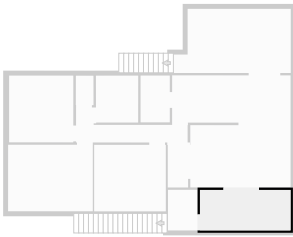

▼ **Living Room**
1st Floor

WIDTH: 5.08 m • LENGTH: 3.15 m
AREA: 16.01 m² • PERIMETER: 16.46 m

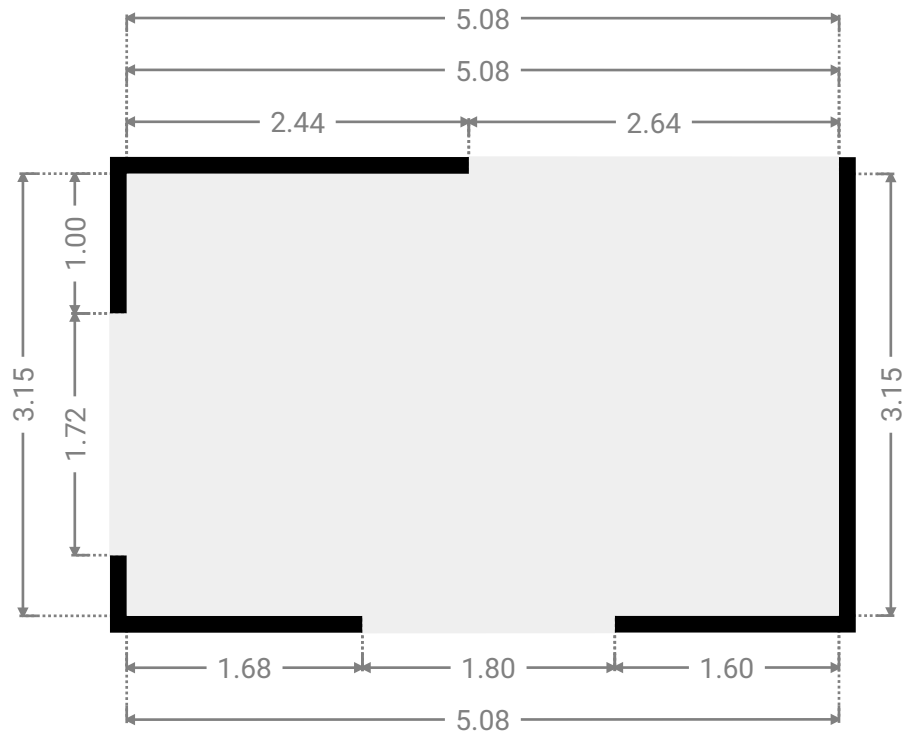
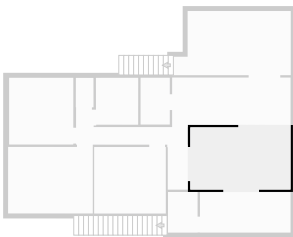

▼ **Other**
1st Floor

WIDTH: 6.01 m • LENGTH: 3.25 m
AREA: 17.72 m² • PERIMETER: 18.52 m

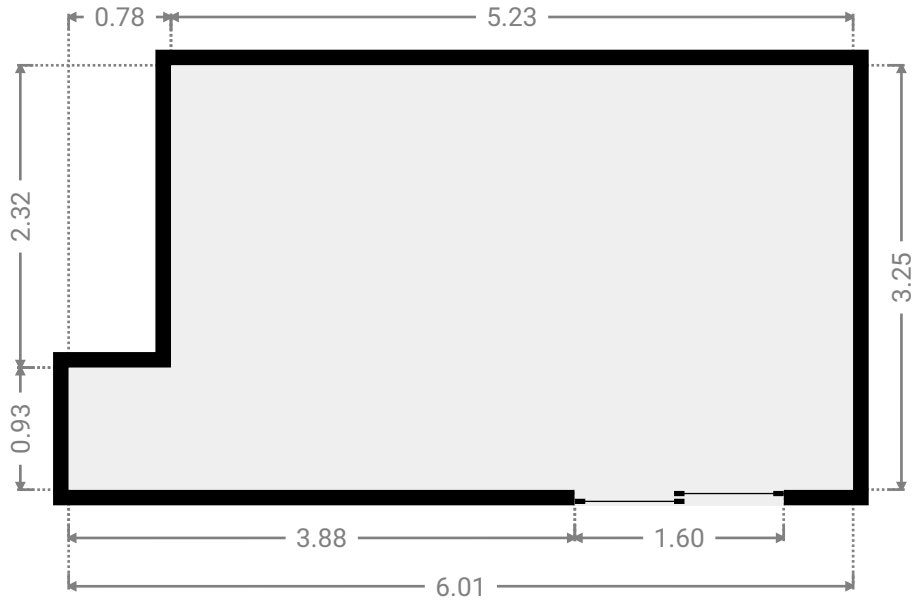
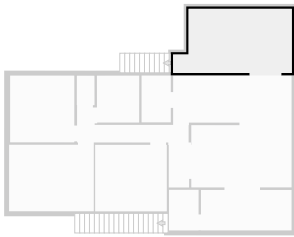

▼ **Toilet**
1st Floor

WIDTH: 0.90 m • LENGTH: 1.49 m
AREA: 1.33 m² • PERIMETER: 4.77 m

