

# Ground Floor



THIS FLOORPLAN IS PROVIDED WITHOUT WARRANTY OF ANY KIND. SENSOPIA DISCLAIMS ANY WARRANTY INCLUDING, WITHOUT LIMITATION, SATISFACTORY QUALITY OR ACCURACY OF DIMENSIONS.



37 Springfield Drive

186 m<sup>2</sup>

# Living Room

Width: 6.22 m  
 Length: 6.75 m  
 Area: 35.15 m<sup>2</sup>  
 Perimeter: 26.84 m  
 Ceiling Height: 2.17 m

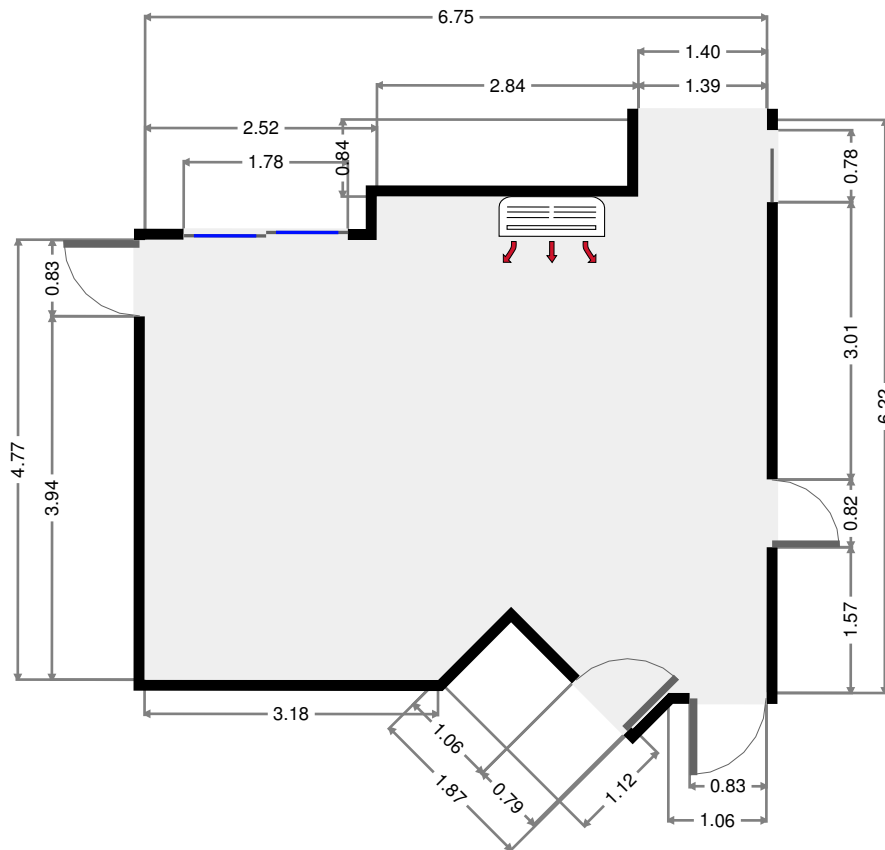
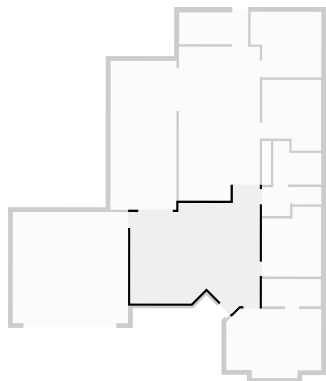

# Master Bedroom

Width: 3.60 m  
 Length: 4.95 m  
 Area: 16.56 m<sup>2</sup>  
 Perimeter: 16.73 m  
 Ceiling Height: 2.17 m

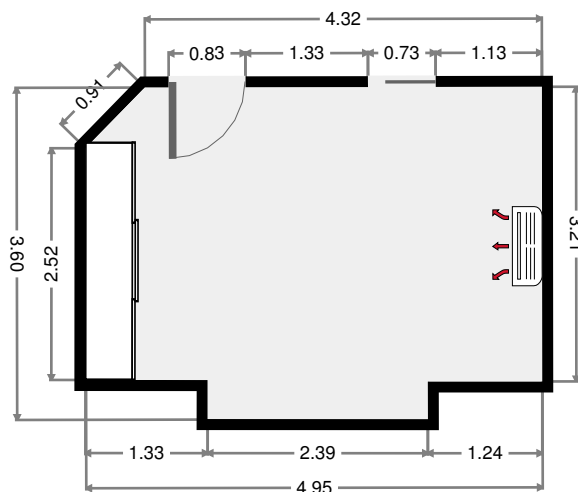
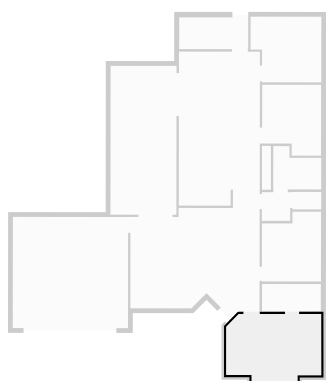

THIS FLOORPLAN IS PROVIDED WITHOUT WARRANTY OF ANY KIND. SENSOPIA DISCLAIMS ANY WARRANTY INCLUDING, WITHOUT LIMITATION, SATISFACTORY QUALITY OR ACCURACY OF DIMENSIONS.



**37 Springfield Drive**

2017-02-14

# Bathroom

Width: 1.41 m  
 Length: 3.07 m  
 Area: 4.36 m<sup>2</sup>  
 Perimeter: 8.98 m

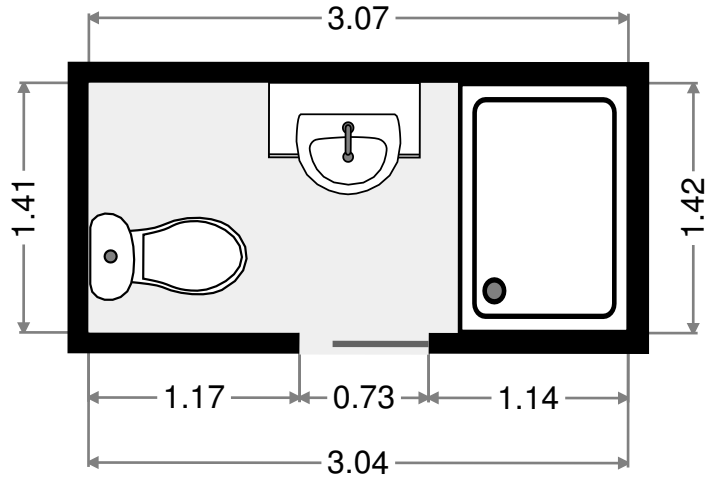
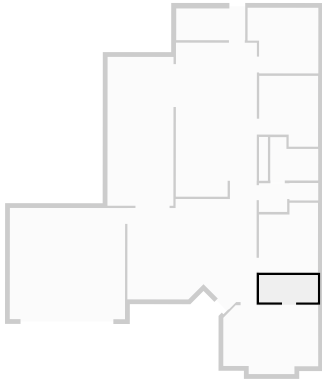

# Bedroom

Width: 3.08 m  
 Length: 3.64 m  
 Area: 10.25 m<sup>2</sup>  
 Perimeter: 13.45 m

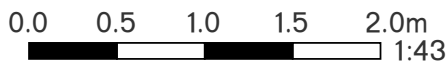
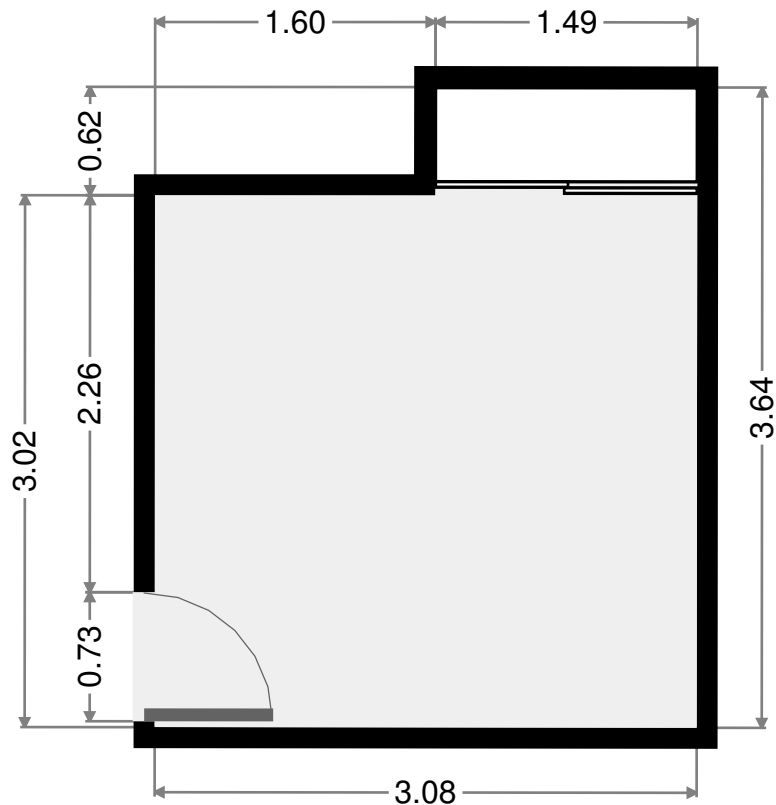
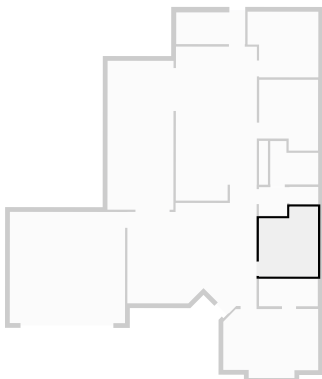

THIS FLOORPLAN IS PROVIDED WITHOUT WARRANTY OF ANY KIND. SENSOPIA DISCLAIMS ANY WARRANTY INCLUDING, WITHOUT LIMITATION, SATISFACTORY QUALITY OR ACCURACY OF DIMENSIONS.

# Vanity

Width: 1.48 m  
 Length: 1.49 m  
 Area: 2.21 m<sup>2</sup>  
 Perimeter: 5.95 m

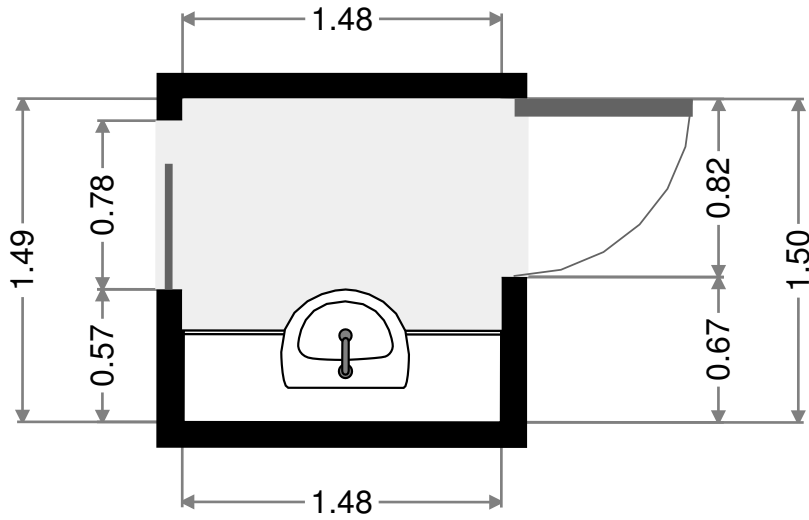
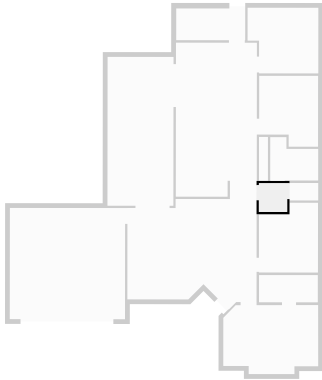

# Toilet

Width: 0.91 m  
 Length: 1.50 m  
 Area: 1.37 m<sup>2</sup>  
 Perimeter: 4.83 m

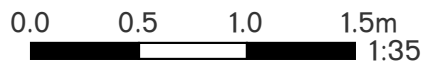
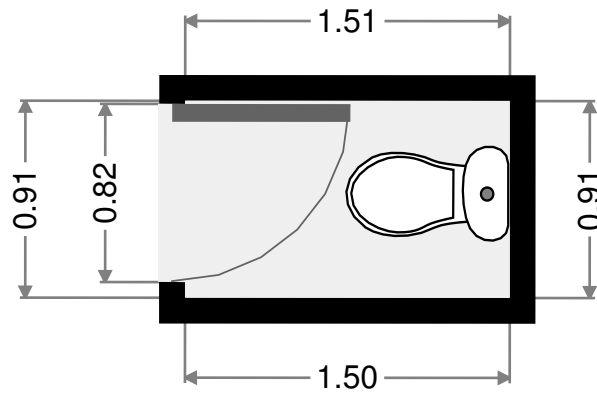
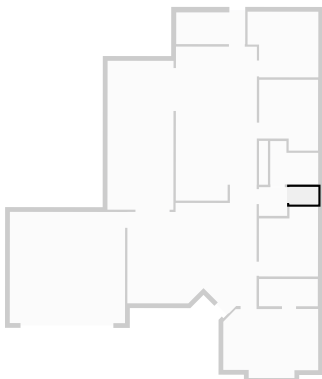

THIS FLOORPLAN IS PROVIDED WITHOUT WARRANTY OF ANY KIND. SENSOPIA DISCLAIMS ANY WARRANTY INCLUDING, WITHOUT LIMITATION, SATISFACTORY QUALITY OR ACCURACY OF DIMENSIONS.

# Bathroom

Width: 2.25 m  
 Length: 2.51 m  
 Area: 4.65 m<sup>2</sup>  
 Perimeter: 9.53 m

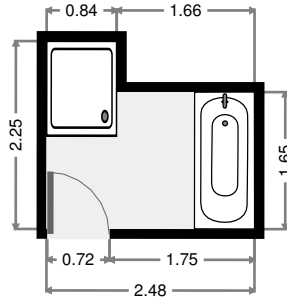
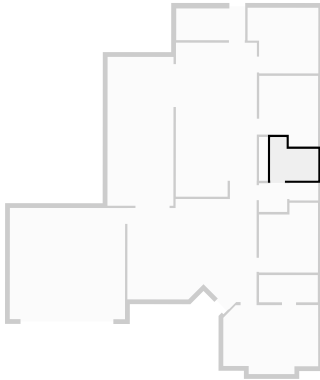

# Kitchen/Dining

Width: 4.23 m  
 Length: 8.04 m  
 Area: 32.74 m<sup>2</sup>  
 Perimeter: 24.54 m

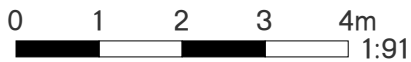
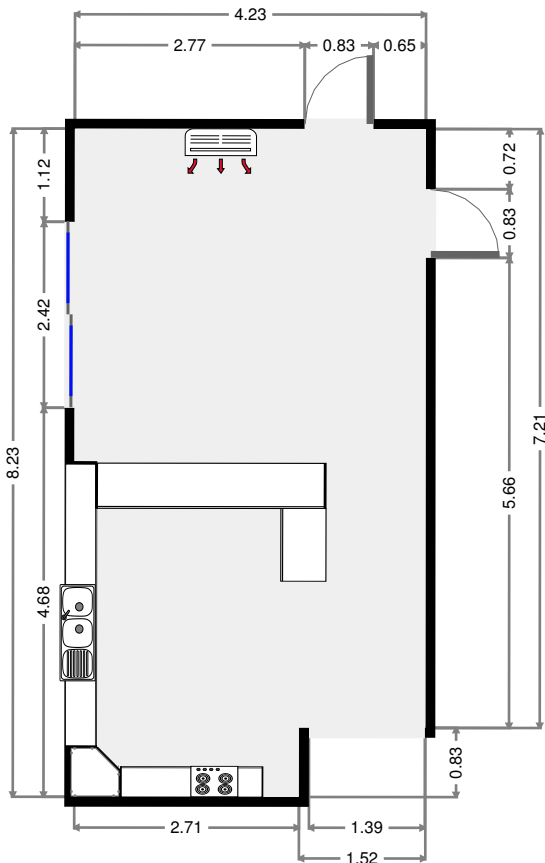
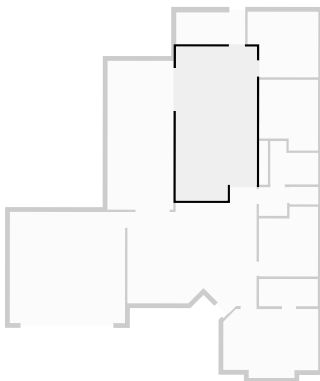

THIS FLOORPLAN IS PROVIDED WITHOUT WARRANTY OF ANY KIND. SENSOPIA DISCLAIMS ANY WARRANTY INCLUDING, WITHOUT LIMITATION, SATISFACTORY QUALITY OR ACCURACY OF DIMENSIONS.

# Laundry Room

Width: 1.65 m  
 Length: 3.60 m  
 Area: 5.97 m<sup>2</sup>  
 Perimeter: 10.52 m

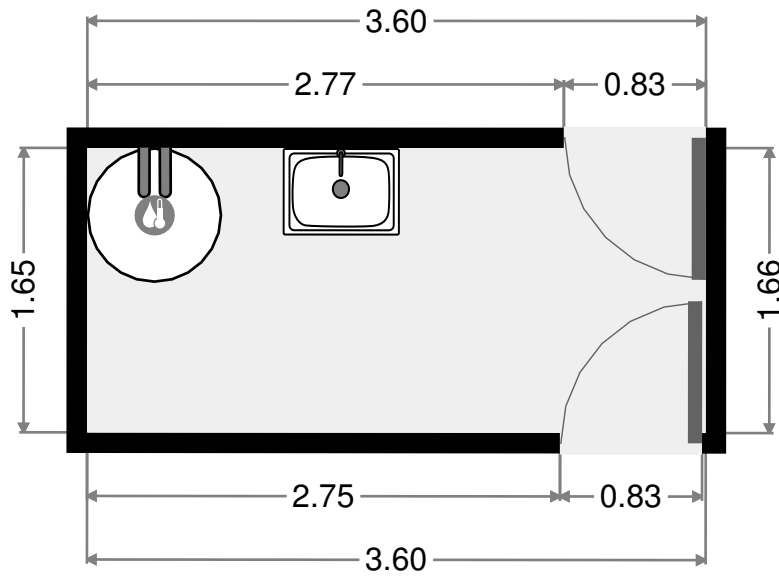
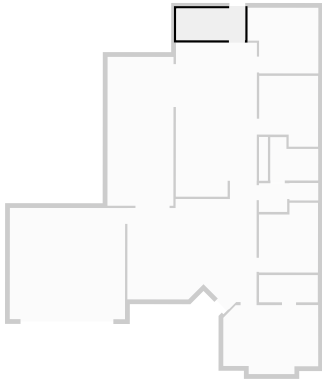

# Bedroom

Width: 3.43 m  
 Length: 3.70 m  
 Area: 11.63 m<sup>2</sup>  
 Perimeter: 14.24 m

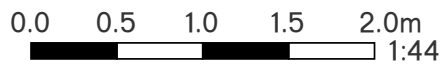
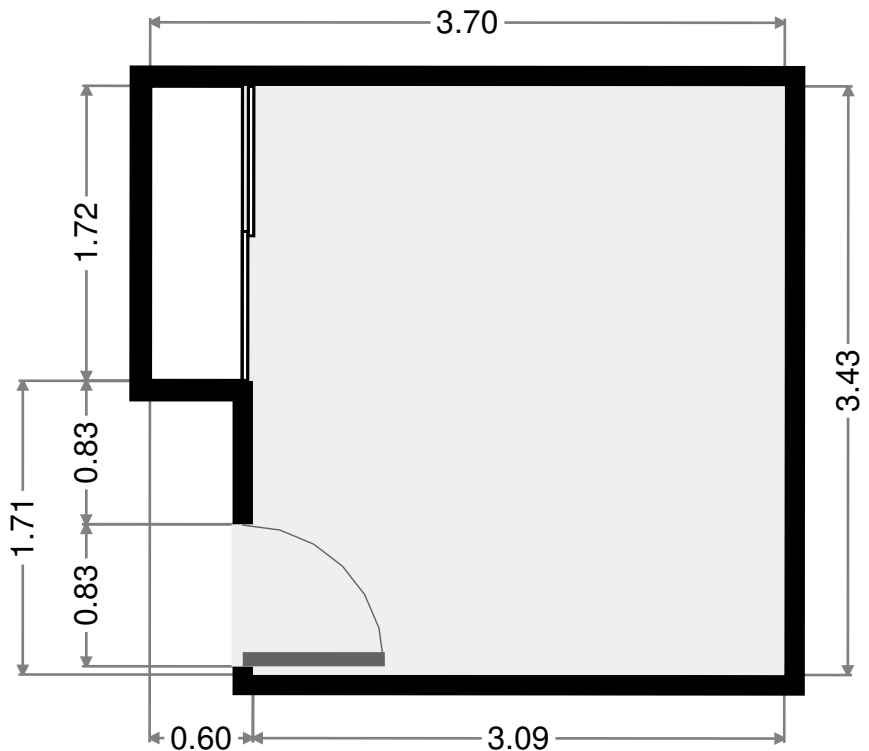
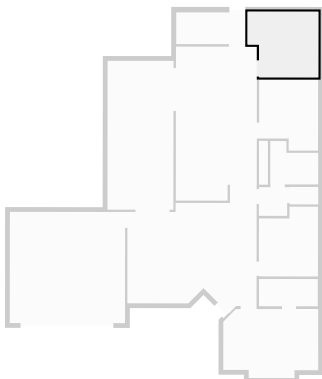

THIS FLOORPLAN IS PROVIDED WITHOUT WARRANTY OF ANY KIND. SENSOPIA DISCLAIMS ANY WARRANTY INCLUDING, WITHOUT LIMITATION, SATISFACTORY QUALITY OR ACCURACY OF DIMENSIONS.

# Bedroom

Width: 3.08 m  
 Length: 3.70 m  
 Area: 10.41 m<sup>2</sup>  
 Perimeter: 13.55 m

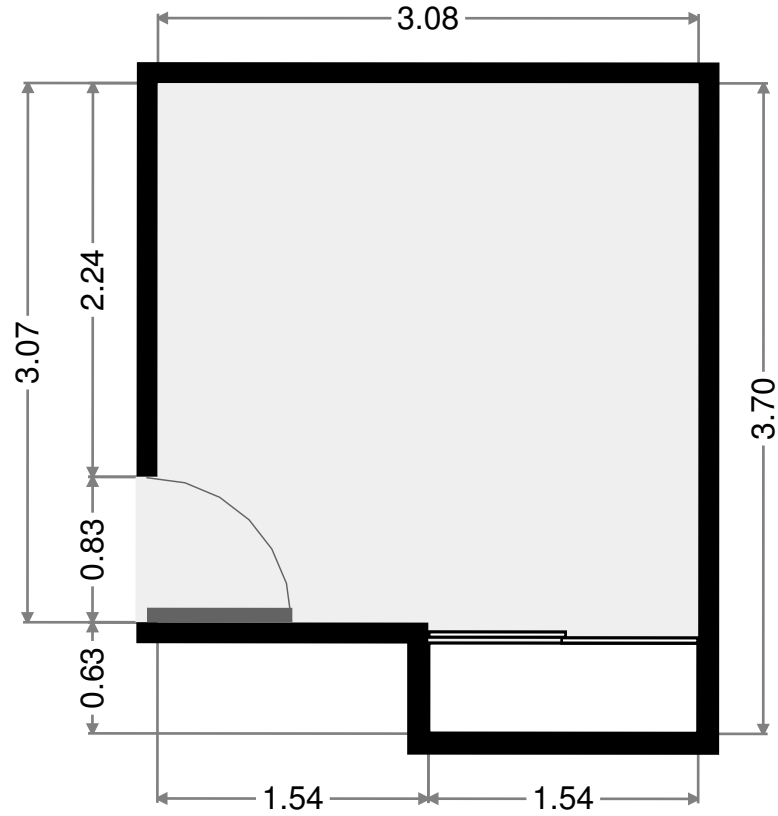
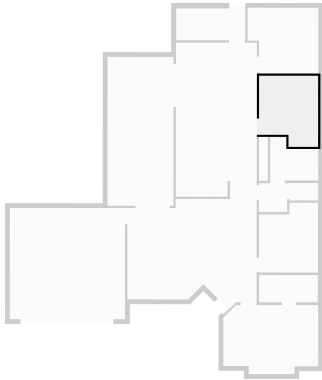

# Closet

Width: 0.47 m  
 Length: 2.29 m  
 Area: 1.07 m<sup>2</sup>  
 Perimeter: 5.51 m

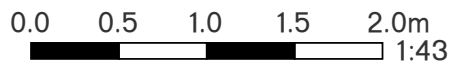
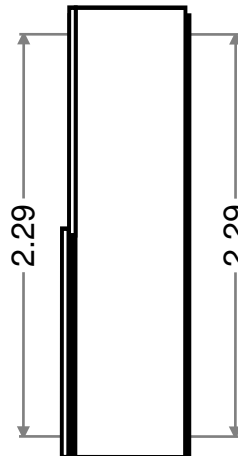
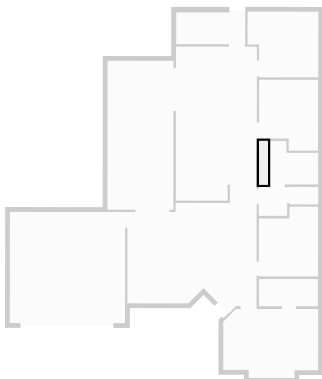

THIS FLOORPLAN IS PROVIDED WITHOUT WARRANTY OF ANY KIND. SENSOPIA DISCLAIMS ANY WARRANTY INCLUDING, WITHOUT LIMITATION, SATISFACTORY QUALITY OR ACCURACY OF DIMENSIONS.

# Outdoor Area

Width: 3.44 m  
 Length: 7.77 m  
 Area: 26.77 m<sup>2</sup>  
 Perimeter: 22.44 m

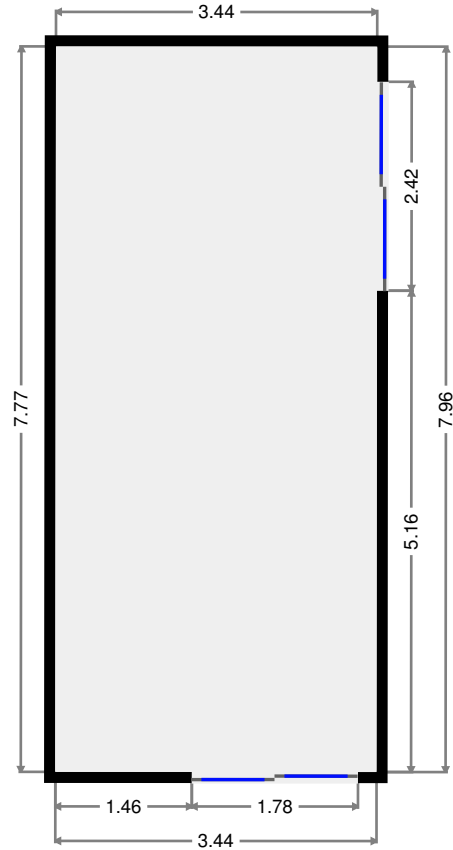
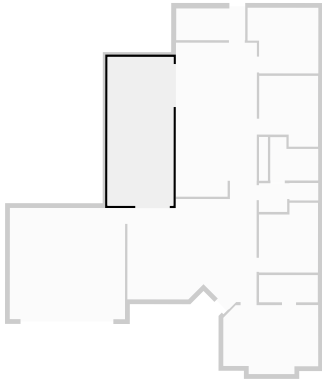

# Garage

Width: 5.81 m  
 Length: 6.02 m  
 Area: 34.96 m<sup>2</sup>  
 Perimeter: 23.66 m

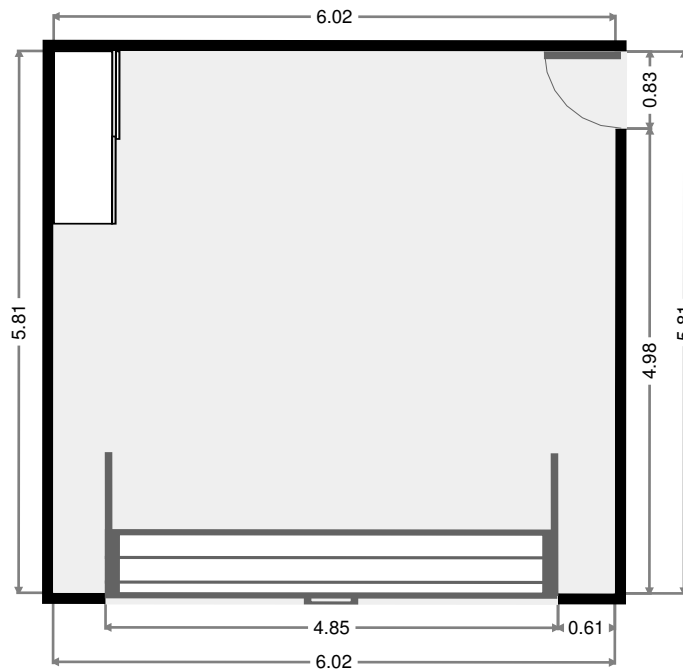
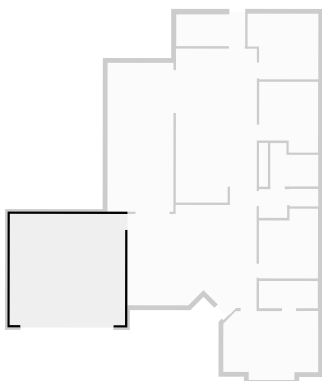

THIS FLOORPLAN IS PROVIDED WITHOUT WARRANTY OF ANY KIND. SENSOPIA DISCLAIMS ANY WARRANTY INCLUDING, WITHOUT LIMITATION, SATISFACTORY QUALITY OR ACCURACY OF DIMENSIONS.