

# 37 Daniel Street

**SUBMITTED BY**  
Ray White Rockhampton Casey  
stockers@cqoz.com

---

**CREATED ON**  
2022-08-29

---

**Floors**  
2

---

▼ Ground Floor

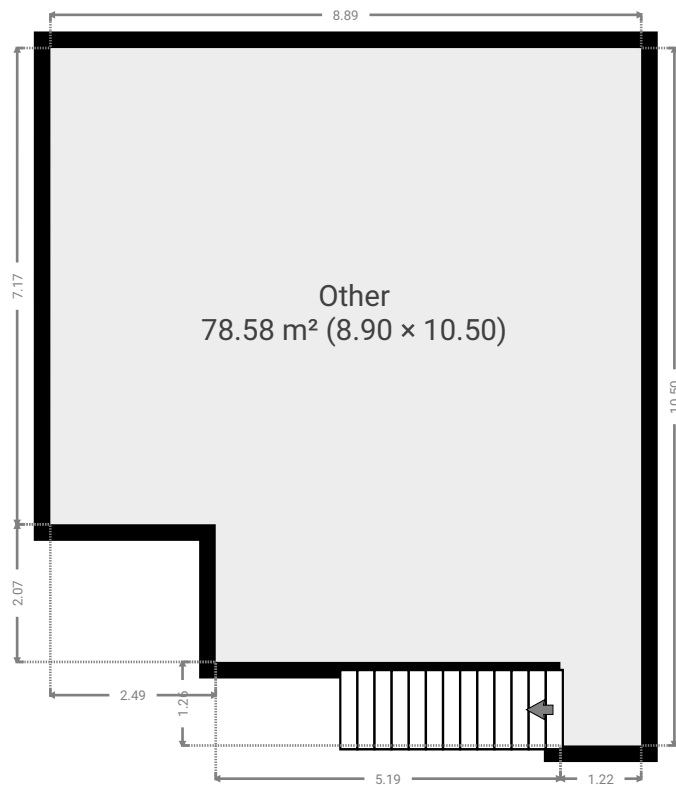

▼ Other  
Ground Floor

WIDTH: 8.90 m • LENGTH: 10.50 m  
AREA: 78.58 m<sup>2</sup> • PERIMETER: 38.79 m

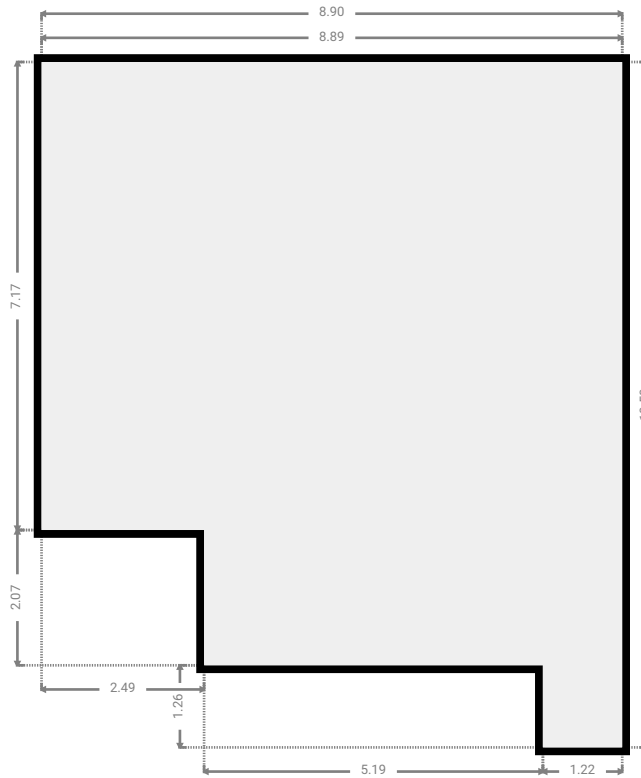
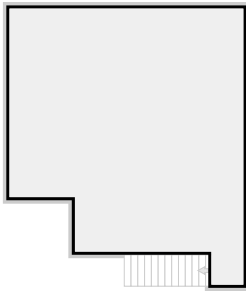

▼ 1st Floor

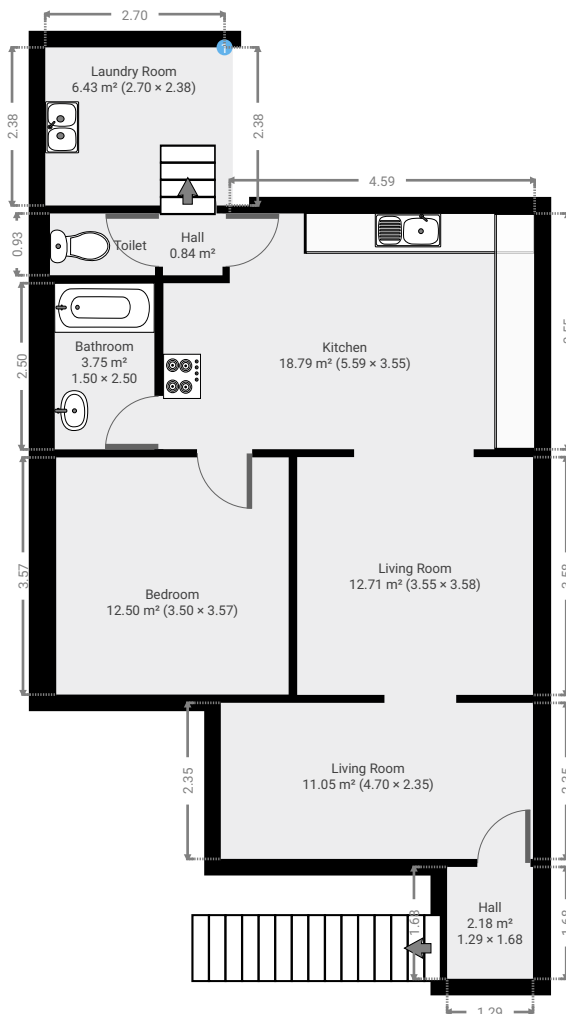
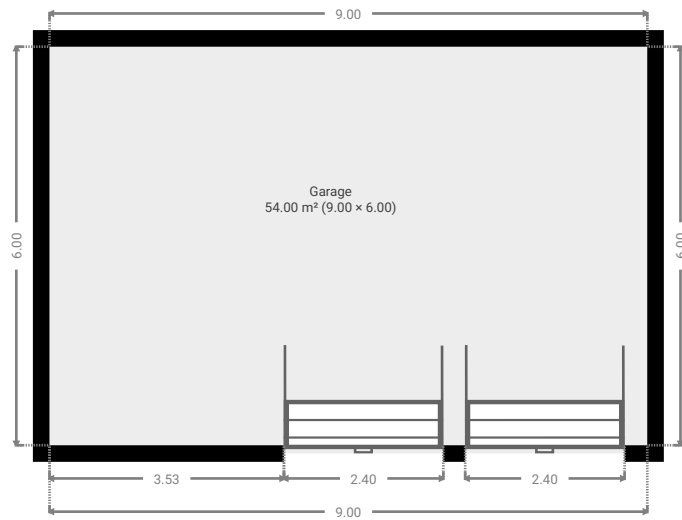

▼ **Bathroom**  
1st Floor

WIDTH: 1.50 m • LENGTH: 2.50 m  
AREA: 3.75 m<sup>2</sup> • PERIMETER: 8.00 m

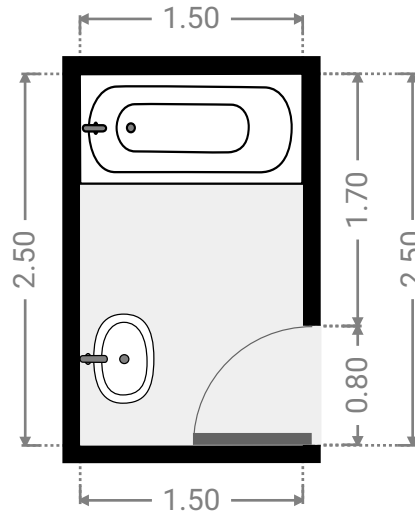
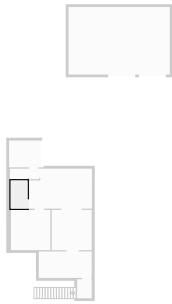

▼ **Bedroom**  
1st Floor

WIDTH: 3.50 m • LENGTH: 3.57 m  
AREA: 12.50 m<sup>2</sup> • PERIMETER: 14.14 m

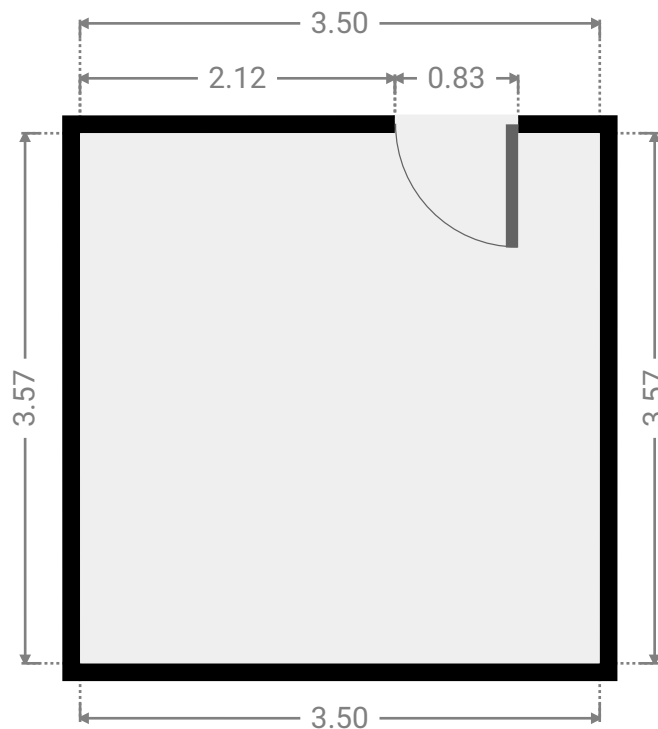
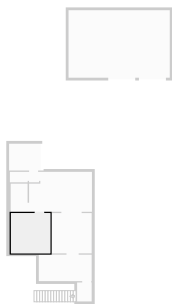

▼ Garage  
1st Floor

WIDTH: 9.00 m • LENGTH: 6.00 m  
AREA: 54.00 m<sup>2</sup> • PERIMETER: 30.00 m

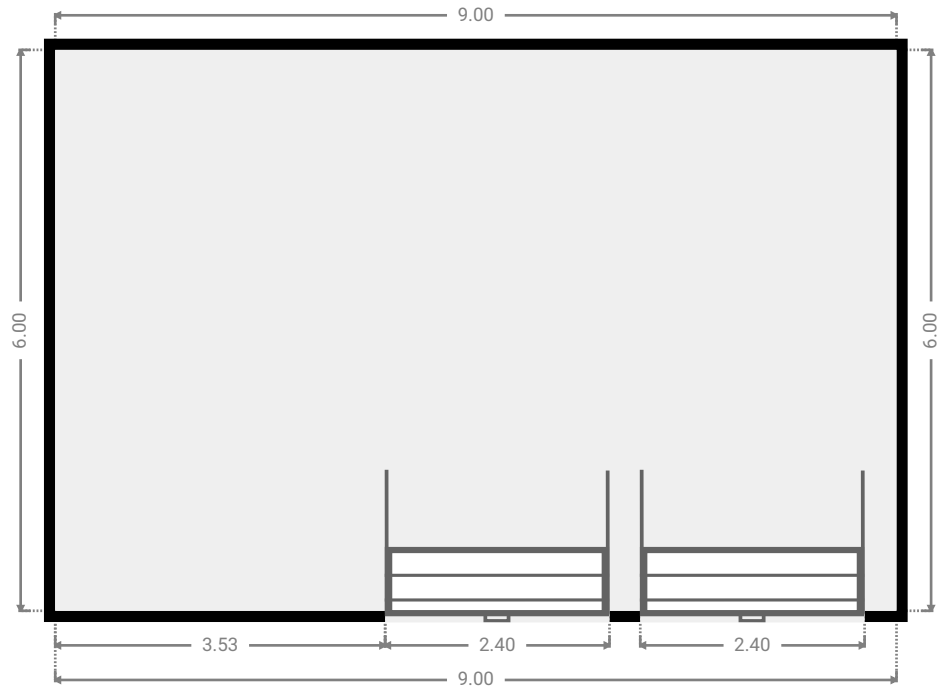
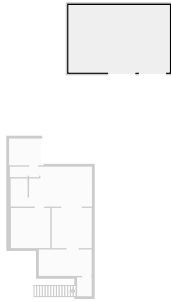

▼ Hall  
1st Floor

WIDTH: 1.29 m • LENGTH: 1.68 m  
AREA: 2.18 m<sup>2</sup> • PERIMETER: 5.95 m

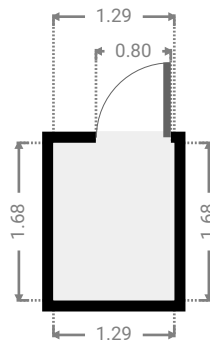
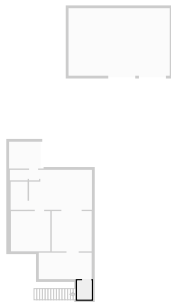

▼ **Hall**  
1st Floor

WIDTH: 0.90 m • LENGTH: 0.93 m  
AREA: 0.84 m<sup>2</sup> • PERIMETER: 3.66 m

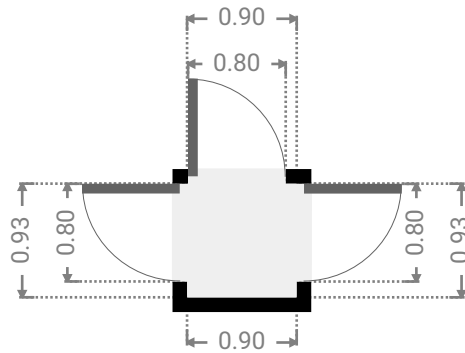
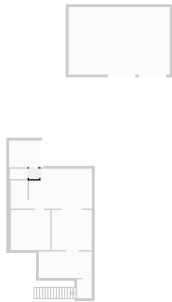

▼ **Kitchen**  
1st Floor

WIDTH: 5.59 m • LENGTH: 3.55 m  
AREA: 18.79 m<sup>2</sup> • PERIMETER: 18.28 m

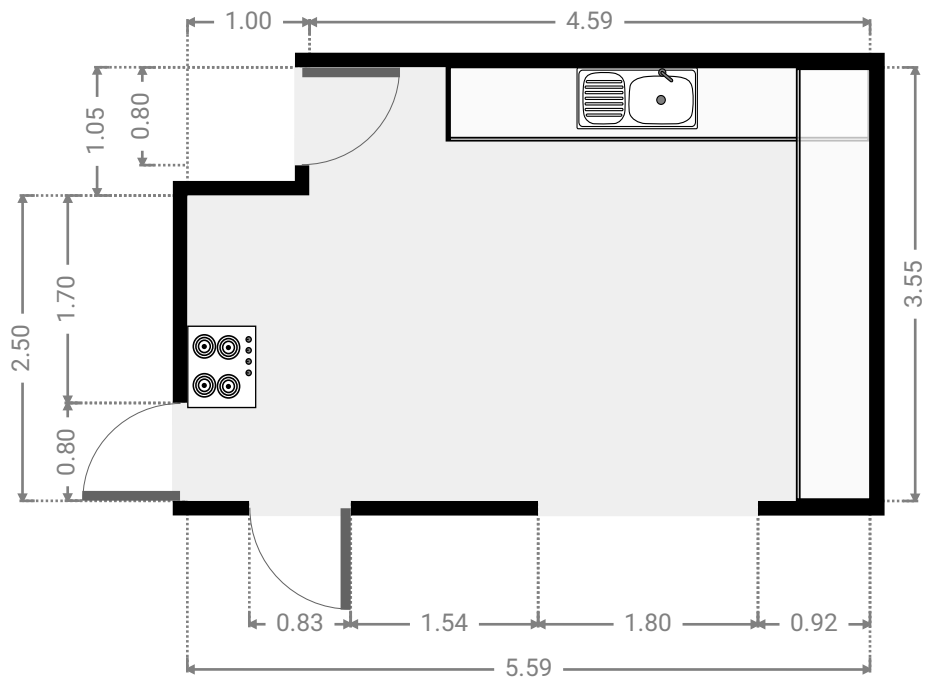
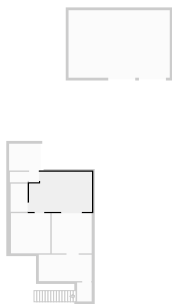

▼ **Laundry Room**  
1st Floor

WIDTH: 2.70 m • LENGTH: 2.38 m  
AREA: 6.43 m<sup>2</sup> • PERIMETER: 10.16 m

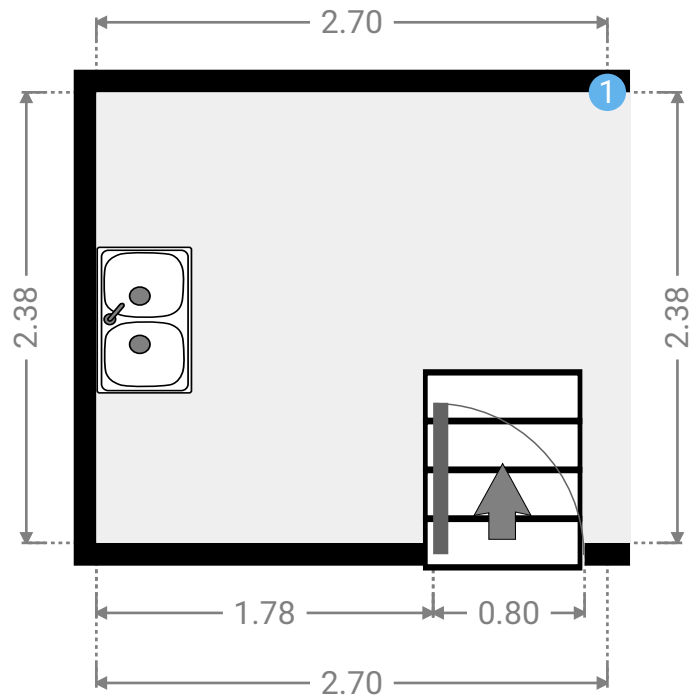
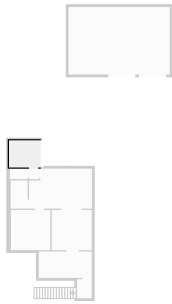

▼ **Laundry Room/1st Floor**

**1 OPENING**

Height  
0.00 m





▼ **Living Room**  
1st Floor

WIDTH: 3.55 m • LENGTH: 3.58 m  
AREA: 12.71 m<sup>2</sup> • PERIMETER: 14.26 m

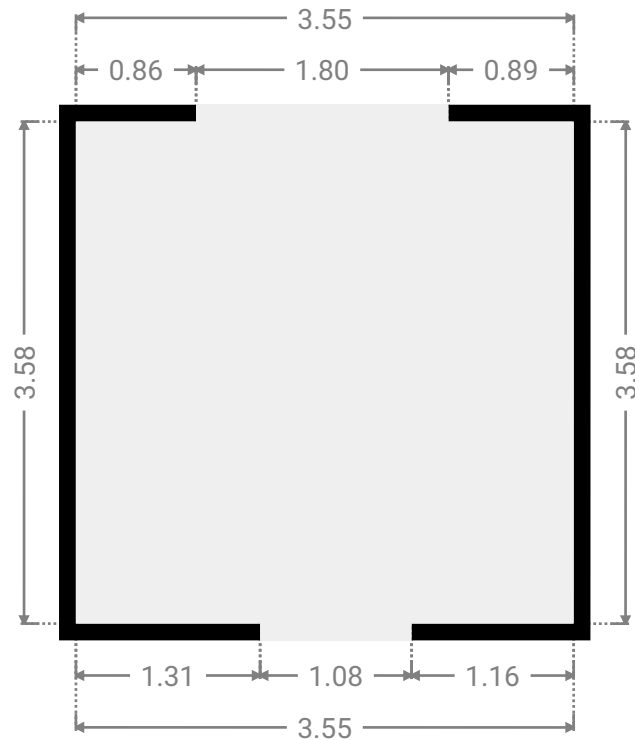
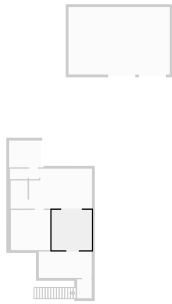

▼ **Living Room**  
1st Floor

WIDTH: 4.70 m • LENGTH: 2.35 m  
AREA: 11.05 m<sup>2</sup> • PERIMETER: 14.10 m

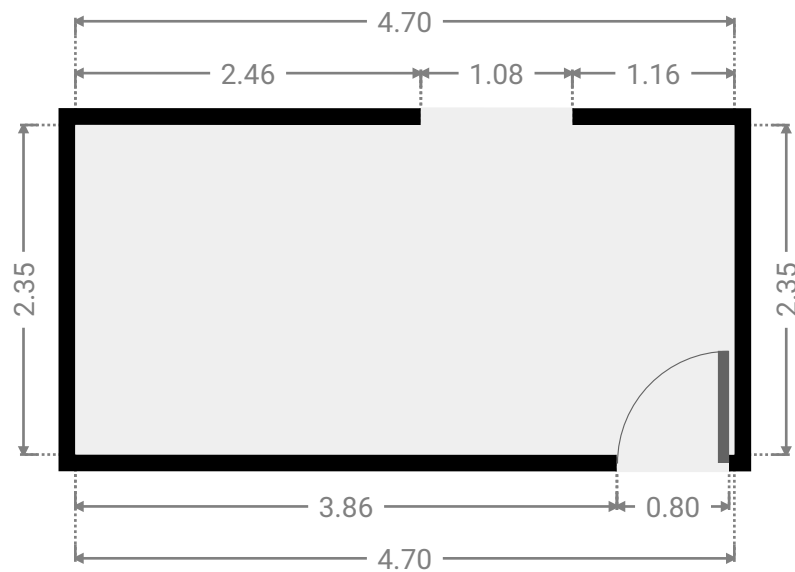
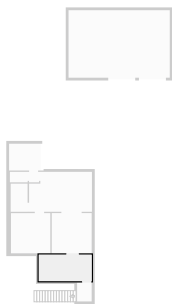

▼ Toilet  
1st Floor

WIDTH: 1.58 m • LENGTH: 0.93 m  
AREA: 1.47 m<sup>2</sup> • PERIMETER: 5.02 m

