

# 37 Brae Street

## Basement

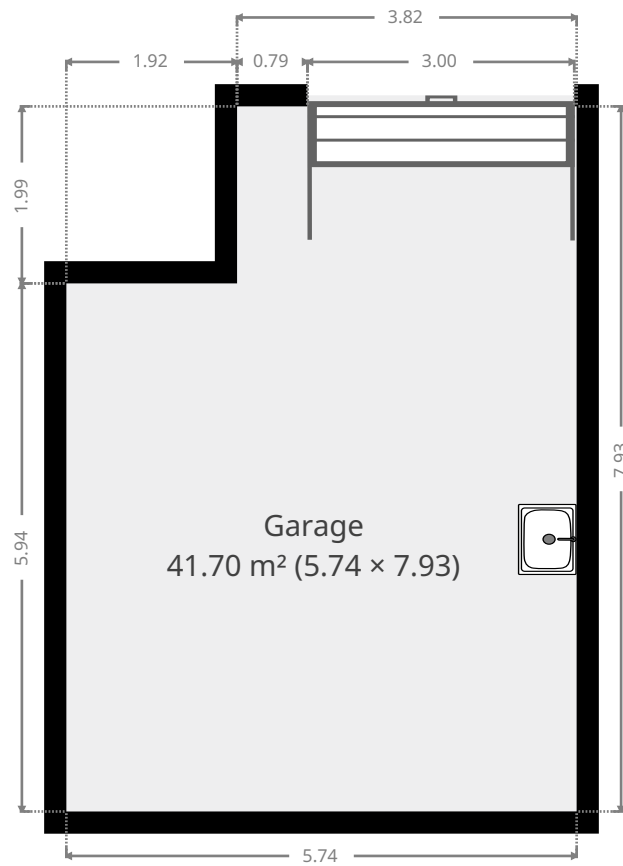

THIS FLOORPLAN IS PROVIDED WITHOUT WARRANTY OF ANY KIND. SENSOPIA DISCLAIMS ANY WARRANTY INCLUDING, WITHOUT LIMITATION, SATISFACTORY QUALITY OR ACCURACY OF DIMENSIONS.



# 37 Brae Street

## Garage

Width: 5.74 m  
Length: 7.93 m  
Area: 41.70 m<sup>2</sup>  
Perimeter: 27.34 m

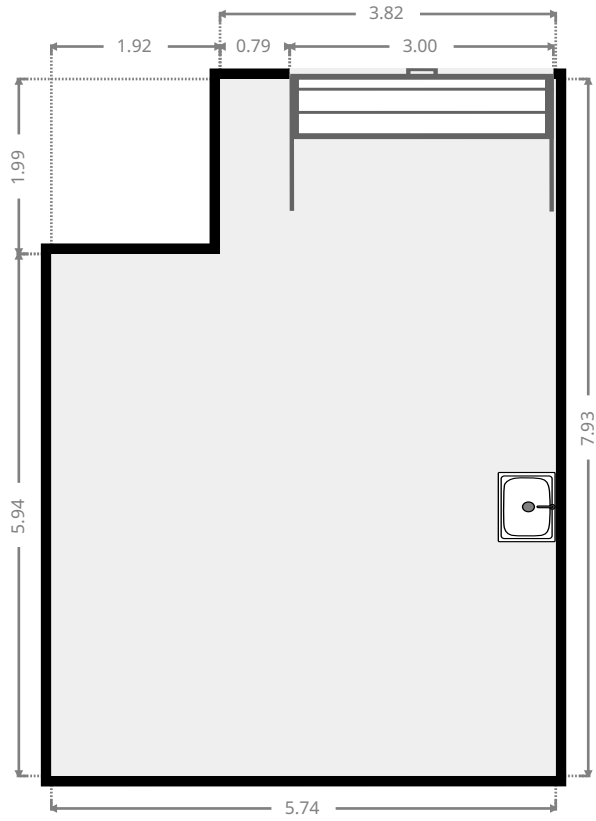
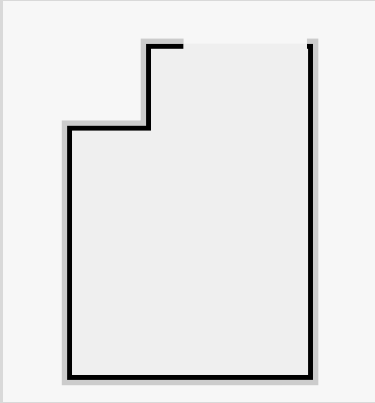

# 37 Brae Street

## Ground Floor



THIS FLOORPLAN IS PROVIDED WITHOUT WARRANTY OF ANY KIND. SENSOPIA DISCLAIMS ANY WARRANTY INCLUDING, WITHOUT LIMITATION, SATISFACTORY QUALITY OR ACCURACY OF DIMENSIONS.



# 37 Brae Street

## Living Room

Width: 4.23 m  
 Length: 7.30 m  
 Area: 30.90 m<sup>2</sup>  
 Perimeter: 23.06 m

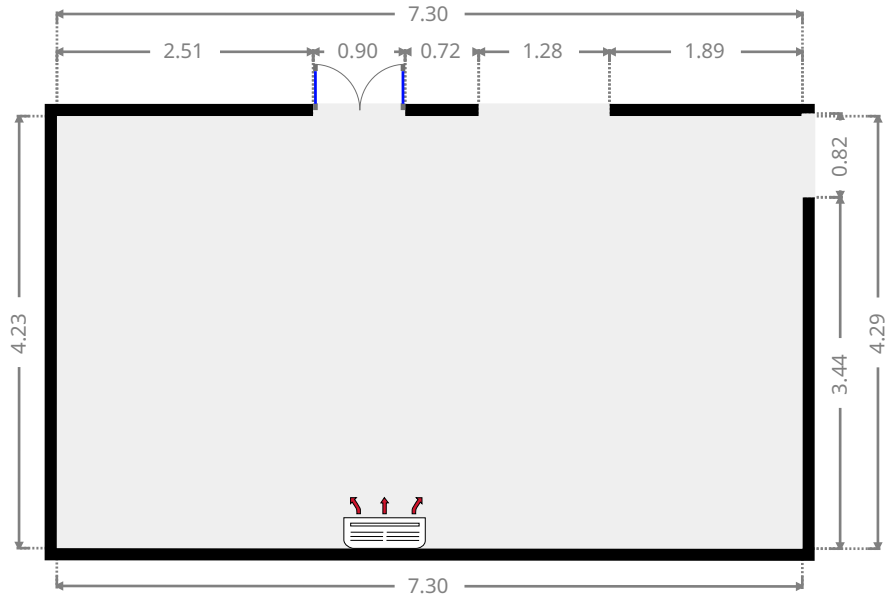
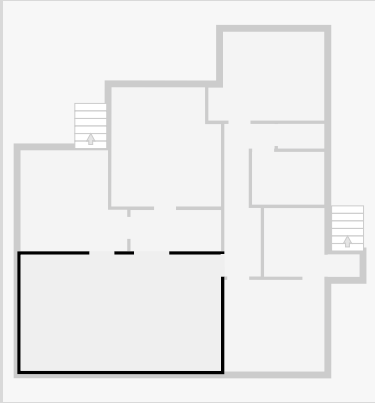

## Hall

Width: 1.83 m  
 Length: 5.56 m  
 Area: 6.88 m<sup>2</sup>  
 Perimeter: 15.66 m

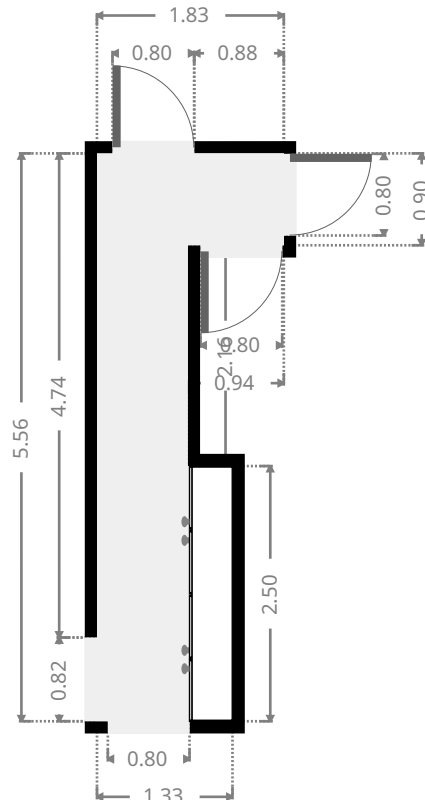
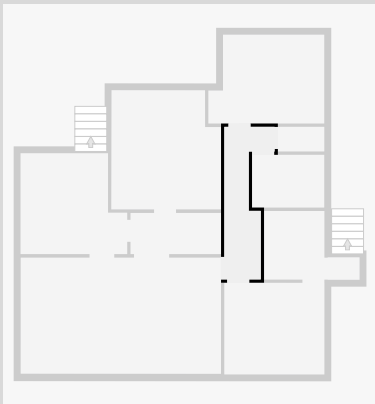

THIS FLOORPLAN IS PROVIDED WITHOUT WARRANTY OF ANY KIND. SENSOPIA DISCLAIMS ANY WARRANTY INCLUDING, WITHOUT LIMITATION, SATISFACTORY QUALITY OR ACCURACY OF DIMENSIONS.



# 37 Brae Street

## Bedroom

Width: 3.24 m  
Length: 4.22 m  
Area: 12.59 m<sup>2</sup>  
Perimeter: 14.92 m

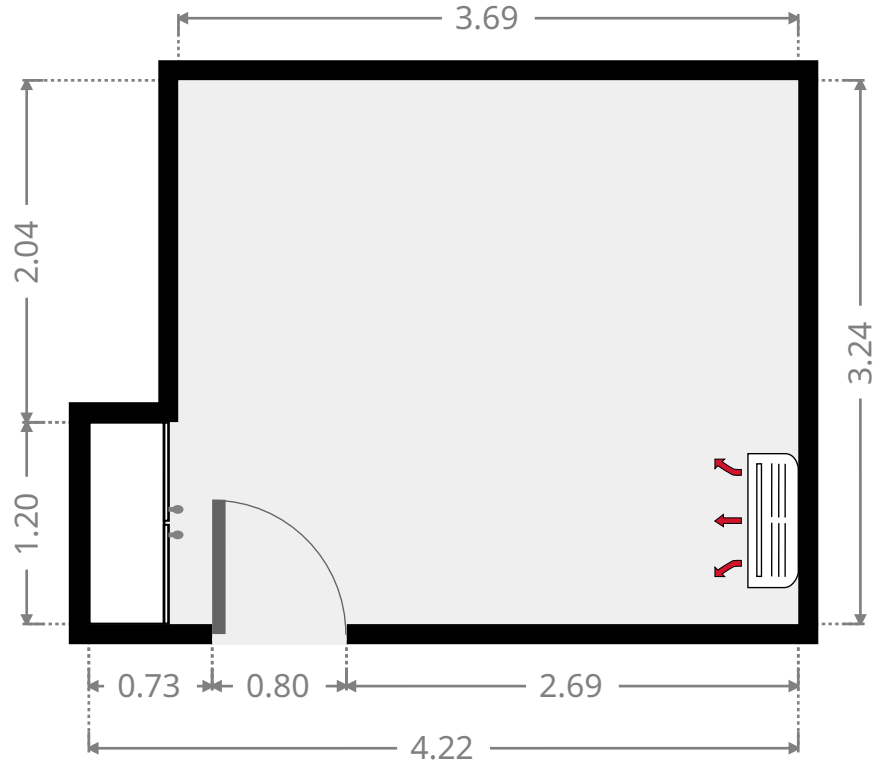
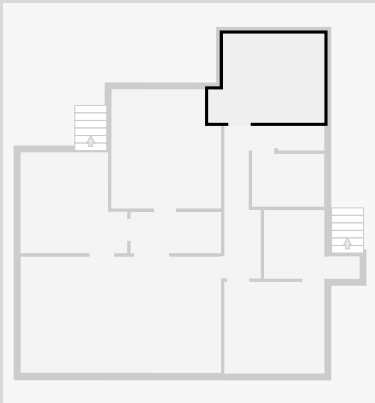

## Toilet / Half Bath

Width: 0.90 m  
Length: 1.69 m  
Area: 1.52 m<sup>2</sup>  
Perimeter: 5.18 m

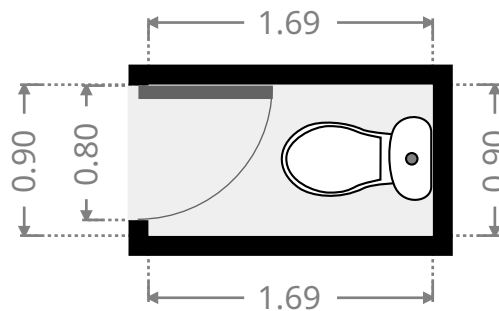
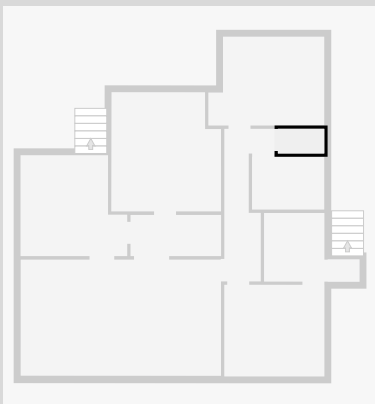

# 37 Brae Street

## Bathroom

Width: 1.92 m  
Length: 2.63 m  
Area: 5.06 m<sup>2</sup>  
Perimeter: 9.11 m

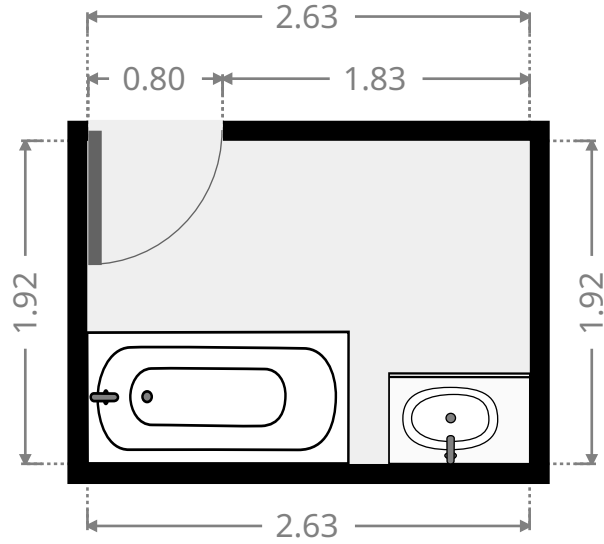
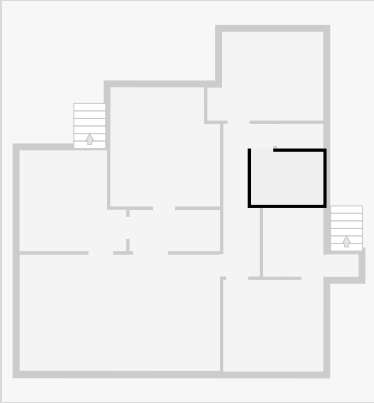

## Kitchen

Width: 3.34 m  
Length: 3.65 m  
Area: 12.19 m<sup>2</sup>  
Perimeter: 13.98 m

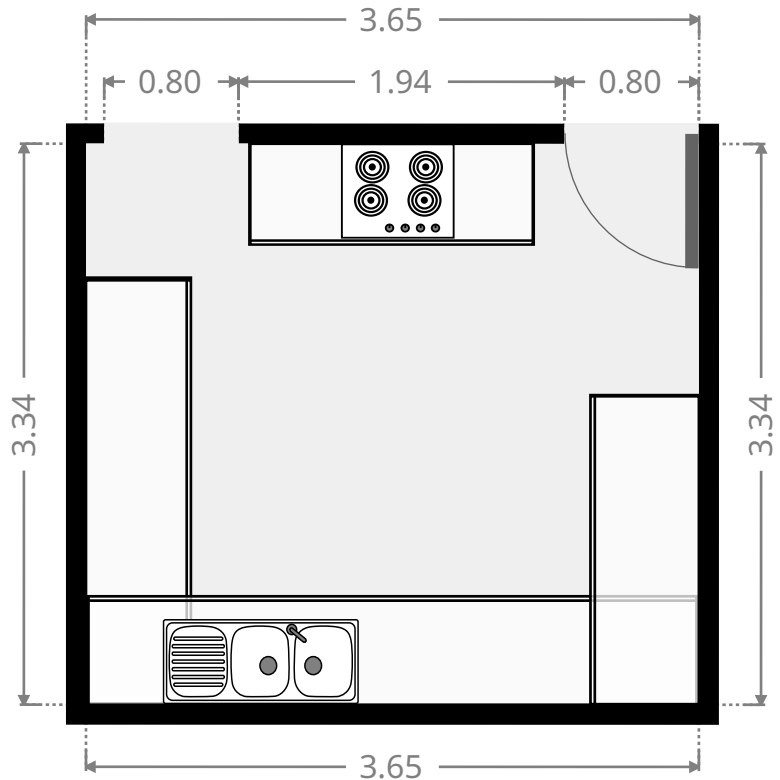
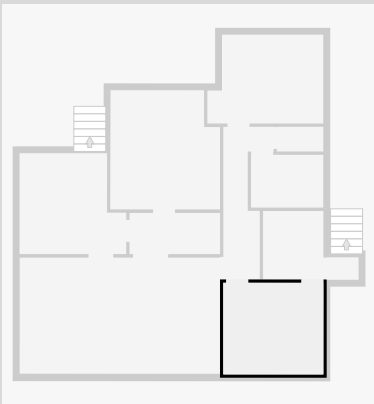

THIS FLOORPLAN IS PROVIDED WITHOUT WARRANTY OF ANY KIND. SENSOPIA DISCLAIMS ANY WARRANTY INCLUDING, WITHOUT LIMITATION, SATISFACTORY QUALITY OR ACCURACY OF DIMENSIONS.

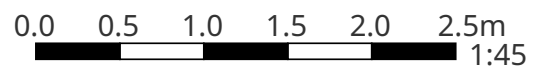

# 37 Brae Street

## Study

Width: 2.20 m  
Length: 2.50 m  
Area: 5.50 m<sup>2</sup>  
Perimeter: 9.40 m

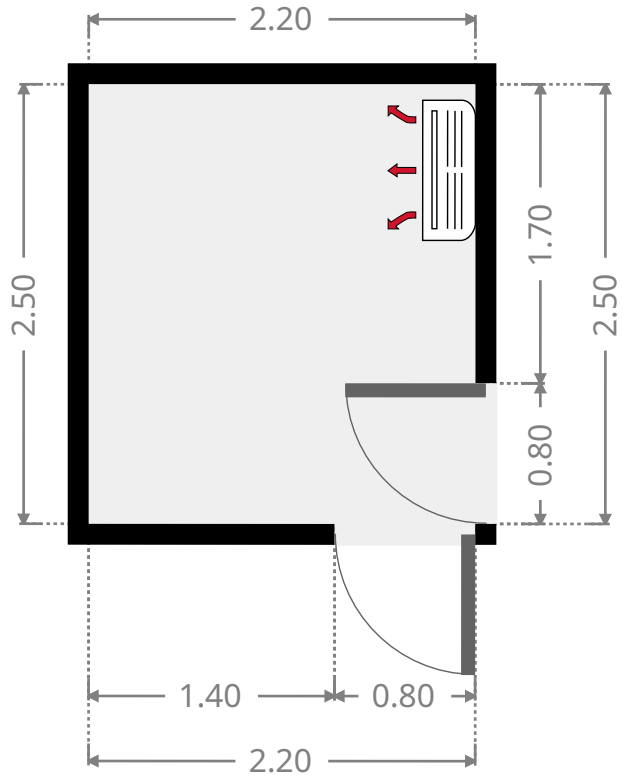
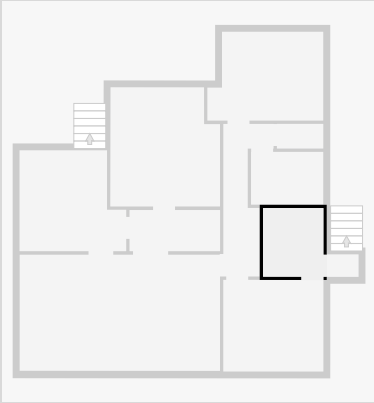

## Hall

Width: 1.50 m  
Length: 3.30 m  
Area: 4.95 m<sup>2</sup>  
Perimeter: 9.60 m

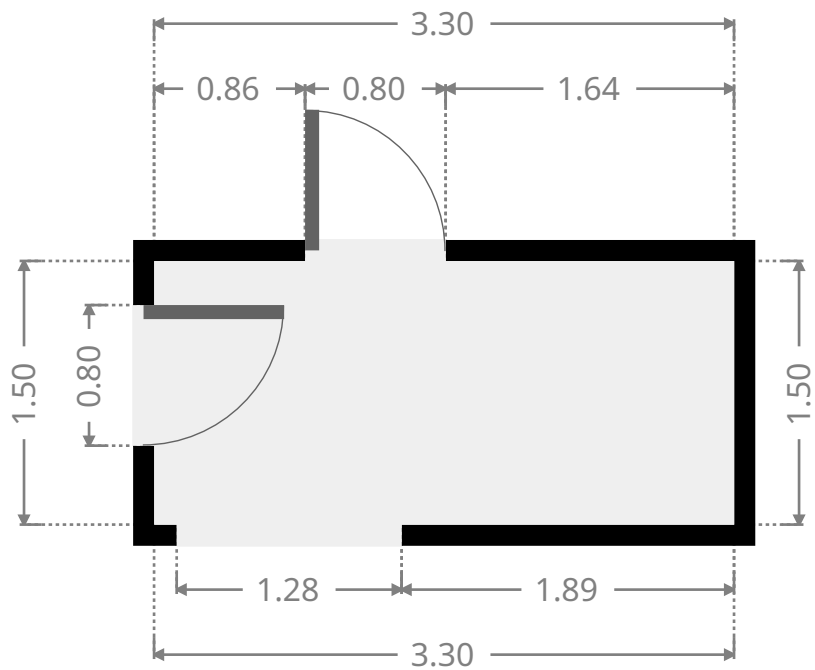
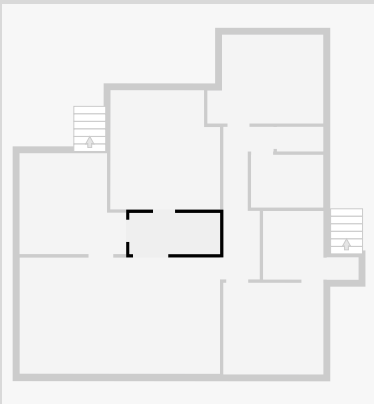

THIS FLOORPLAN IS PROVIDED WITHOUT WARRANTY OF ANY KIND. SENSOPIA DISCLAIMS ANY WARRANTY INCLUDING, WITHOUT LIMITATION, SATISFACTORY QUALITY OR ACCURACY OF DIMENSIONS.

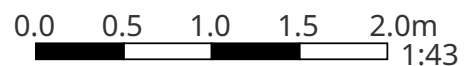

# 37 Brae Street

## Master Bedroom

Width: 4.00 m  
 Length: 4.34 m  
 Area: 16.56 m<sup>2</sup>  
 Perimeter: 16.67 m

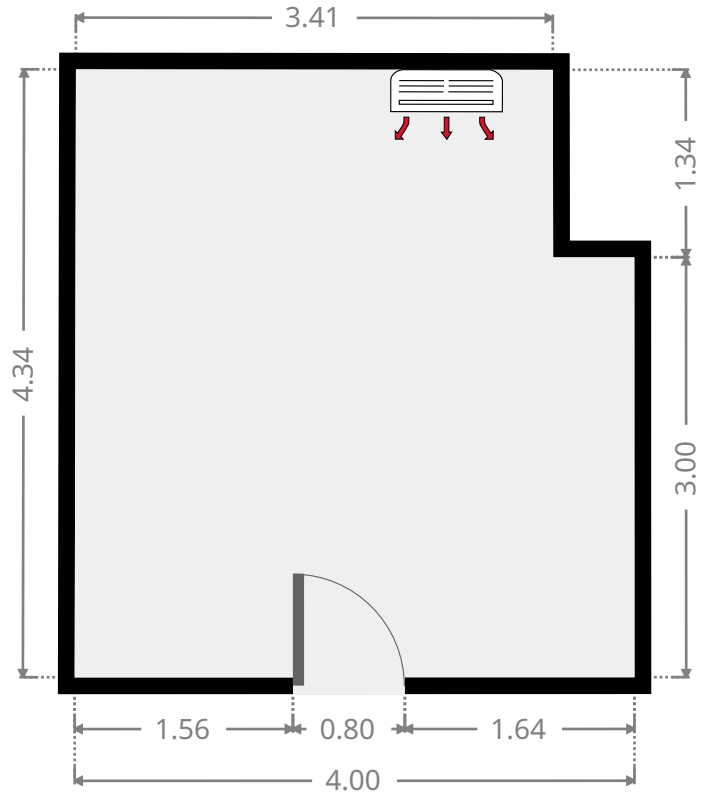
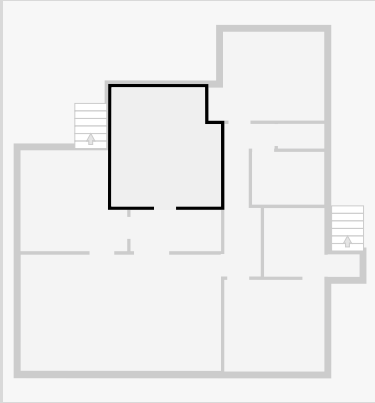

## Other

Width: 3.68 m  
 Length: 3.89 m  
 Area: 12.78 m<sup>2</sup>  
 Perimeter: 15.13 m

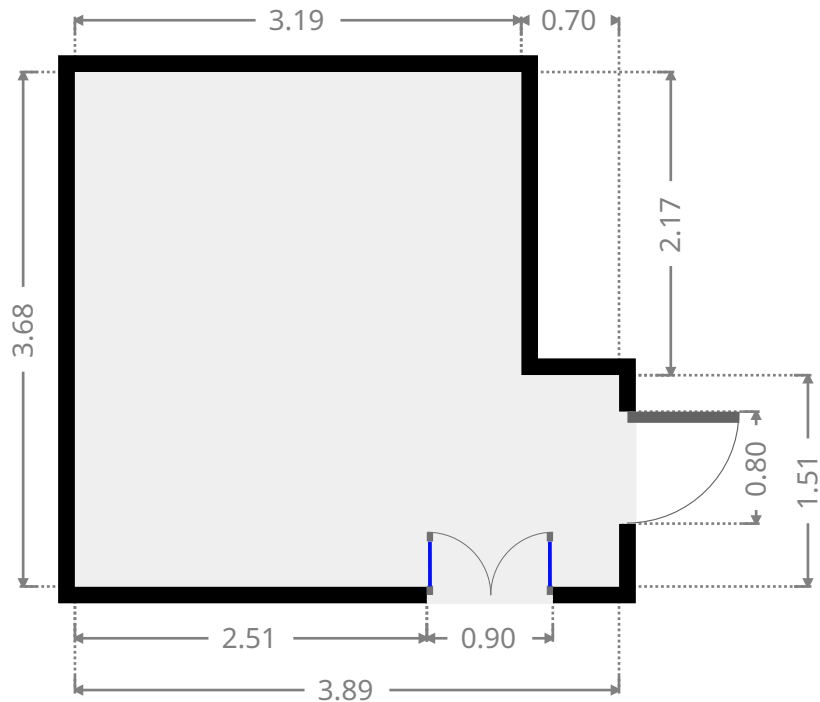
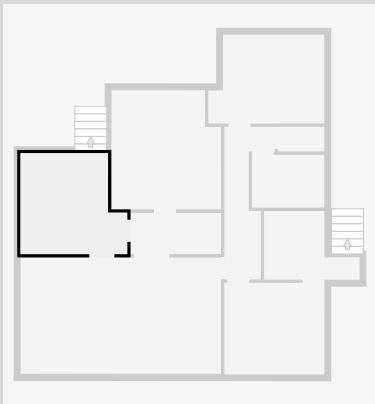

THIS FLOORPLAN IS PROVIDED WITHOUT WARRANTY OF ANY KIND. SENSOPIA DISCLAIMS ANY WARRANTY INCLUDING, WITHOUT LIMITATION, SATISFACTORY QUALITY OR ACCURACY OF DIMENSIONS.

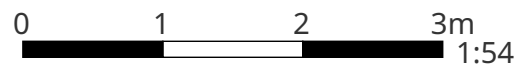



# 37 Brae Street

## Other

Width:	0.82 m
Length:	1.16 m
Area	0.95 m <sup>2</sup>
Perimeter	3.97 m

