

# 37 Bean Avenue

Created on  
2021-01-11

Floors  
2

▼ Ground Floor

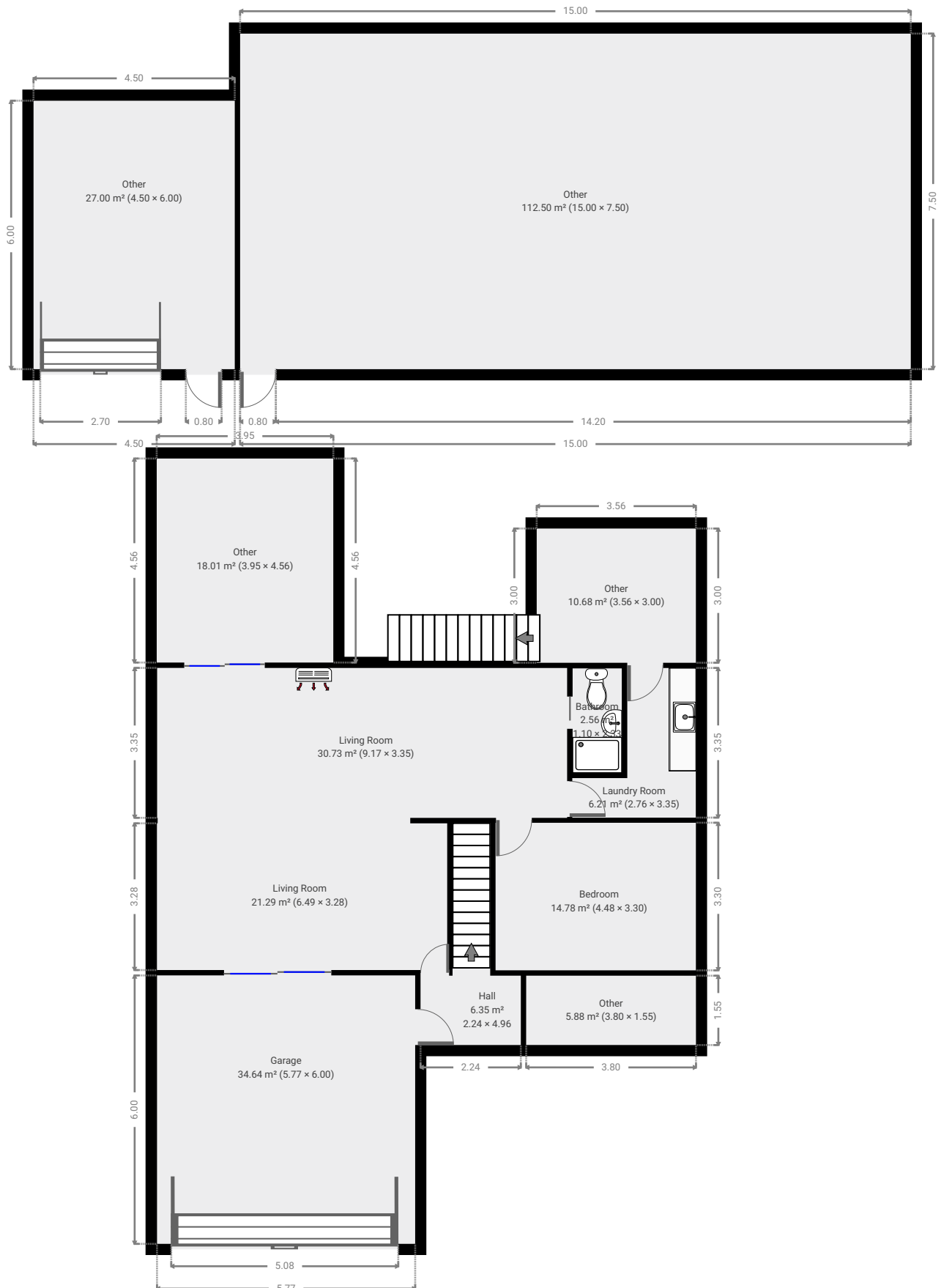

▼ Living Room  
Ground Floor

WIDTH:6.49 m · LENGTH:3.28 m  
AREA:21.29 m<sup>2</sup> · PERIMETER:19.54 m

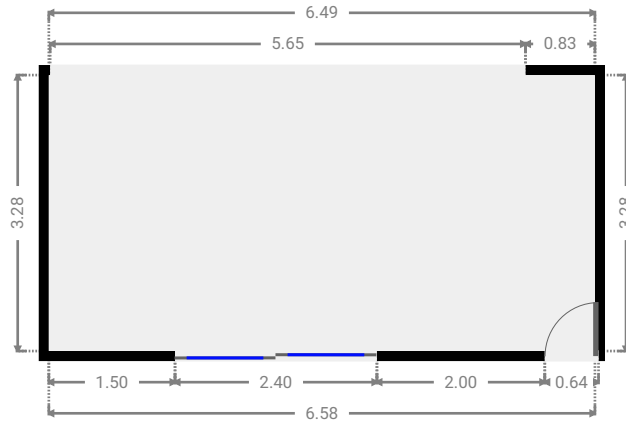
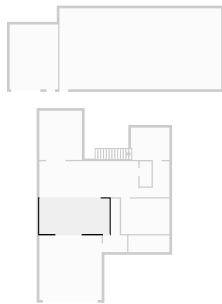

▼ Living Room  
Ground Floor

WIDTH:9.17 m · LENGTH:3.35 m  
AREA:30.73 m<sup>2</sup> · PERIMETER:25.04 m

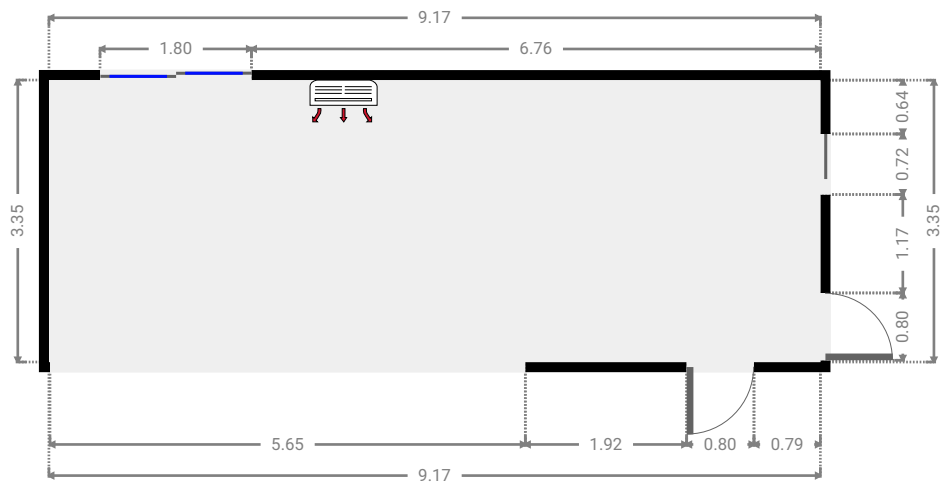
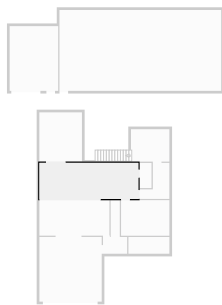

▼ **Bathroom**  
Ground Floor

WIDTH:1.10 m · LENGTH:2.33 m  
AREA:2.56 m<sup>2</sup> · PERIMETER:6.86 m

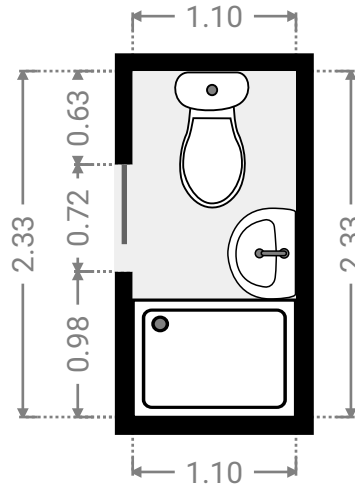
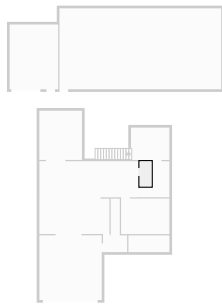

▼ **Laundry Room**  
Ground Floor

WIDTH:2.76 m · LENGTH:3.35 m  
AREA:6.21 m<sup>2</sup> · PERIMETER:12.21 m

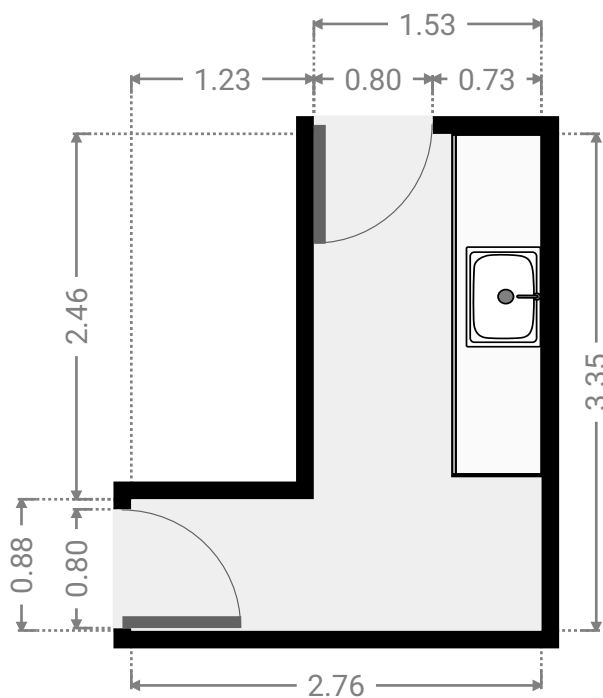
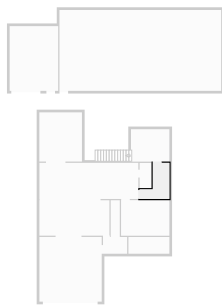

FLOORS:2

▼ **Bedroom**  
Ground Floor

WIDTH:4.48 m · LENGTH:3.30 m  
AREA:14.78 m<sup>2</sup> · PERIMETER:15.56 m

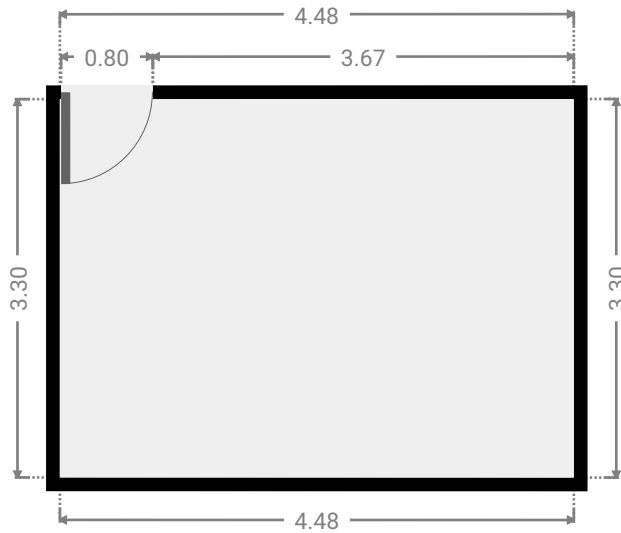
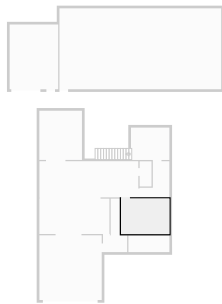

▼ **Hall**  
Ground Floor

WIDTH:2.24 m · LENGTH:4.96 m  
AREA:6.35 m<sup>2</sup> · PERIMETER:14.40 m

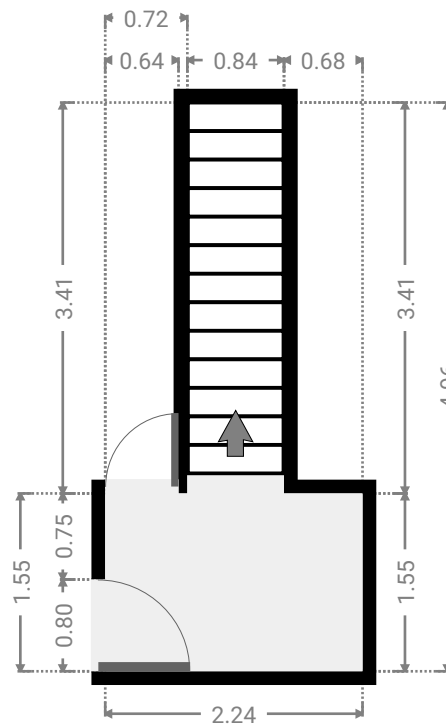
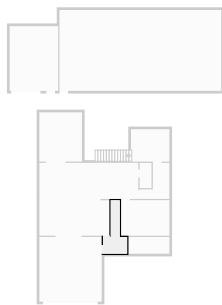

FLOORS:2

▼ Other  
Ground Floor

WIDTH:3.95 m · LENGTH:4.56 m  
AREA:18.01 m<sup>2</sup> · PERIMETER:17.02 m

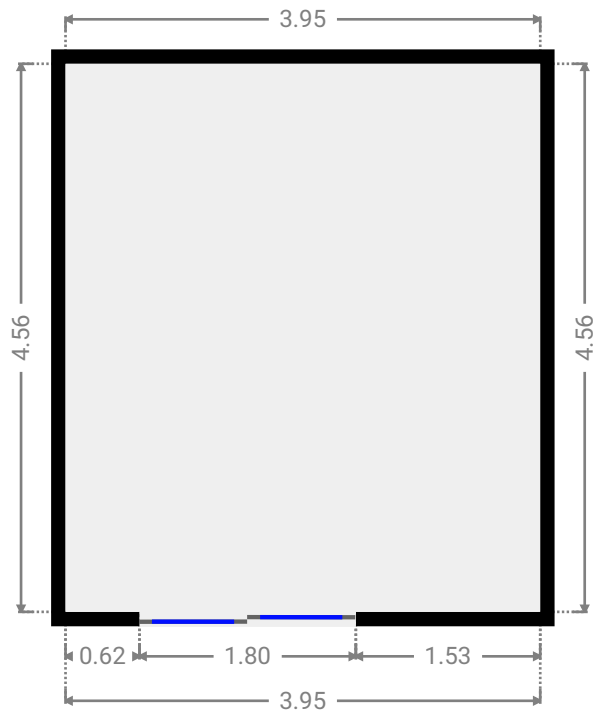
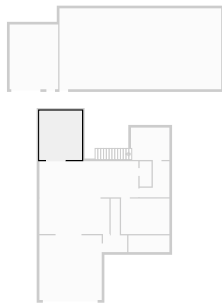

▼ Other  
Ground Floor

WIDTH:3.56 m · LENGTH:3.00 m  
AREA:10.68 m<sup>2</sup> · PERIMETER:13.12 m

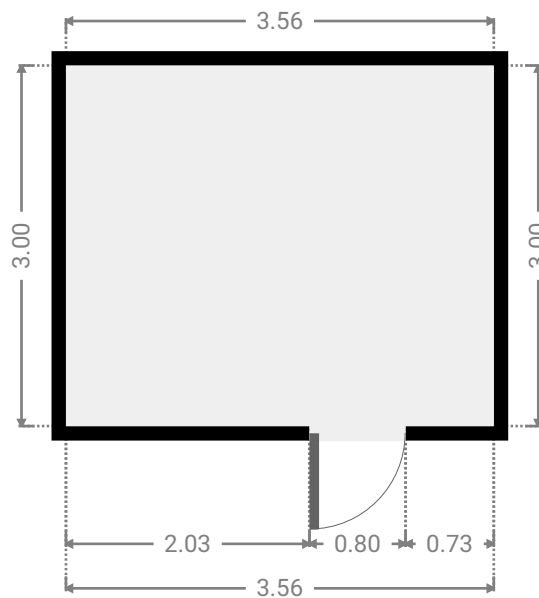
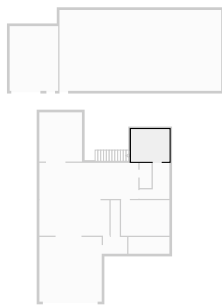

▼ Other  
Ground Floor

WIDTH:4.50 m · LENGTH:6.00 m  
AREA:27.00 m<sup>2</sup> · PERIMETER:21.00 m

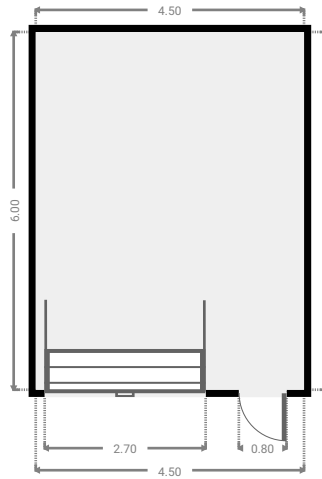

▼ Other  
Ground Floor

WIDTH:15.00 m · LENGTH:7.50 m  
AREA:112.50 m<sup>2</sup> · PERIMETER:45.00 m

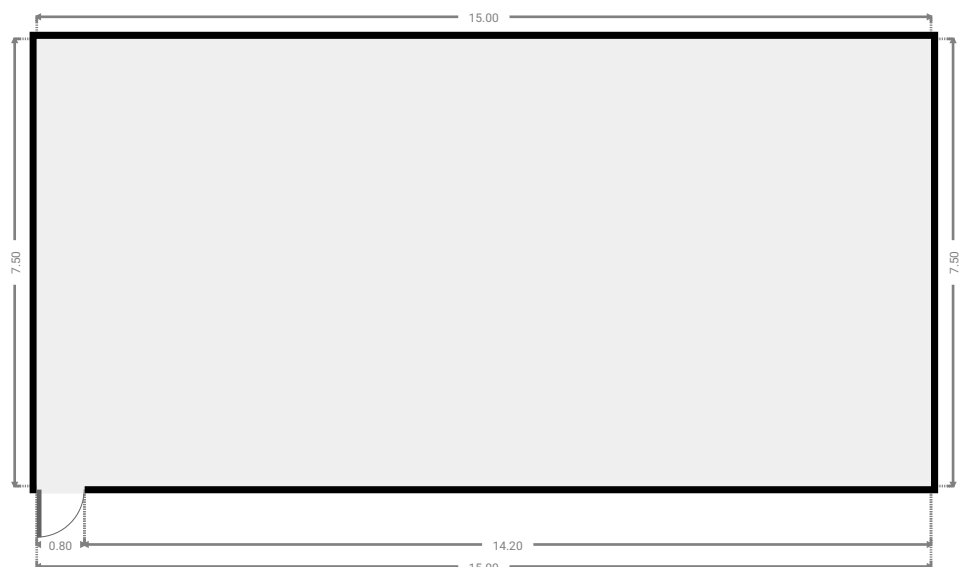
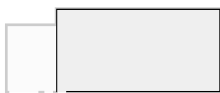

▼ **Garage**  
Ground Floor

WIDTH:5.77 m · LENGTH:6.00 m  
AREA:34.64 m<sup>2</sup> · PERIMETER:23.55 m

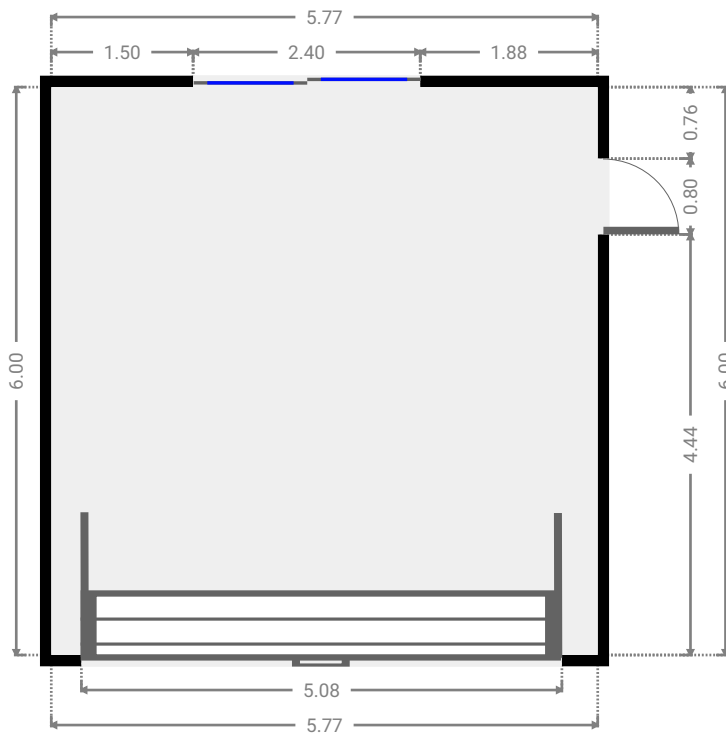
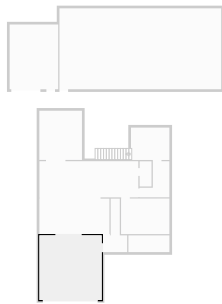

▼ **Other**  
Ground Floor

WIDTH:3.80 m · LENGTH:1.55 m  
AREA:5.88 m<sup>2</sup> · PERIMETER:10.69 m

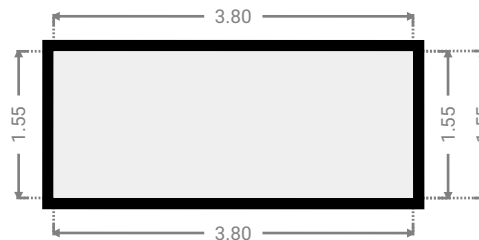
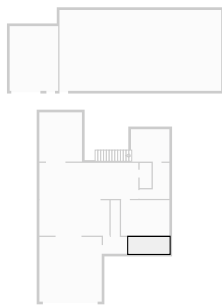



▼ 1st Floor

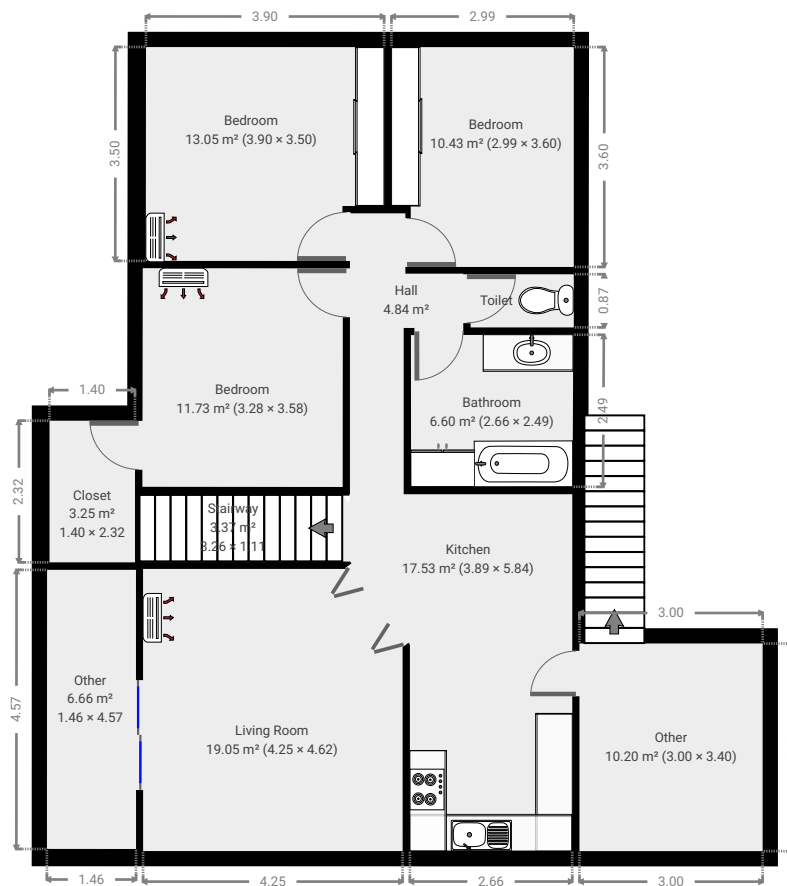

▼ **Living Room**  
1st Floor

WIDTH:4.62 m · LENGTH:4.25 m  
AREA:19.05 m<sup>2</sup> · PERIMETER:17.12 m

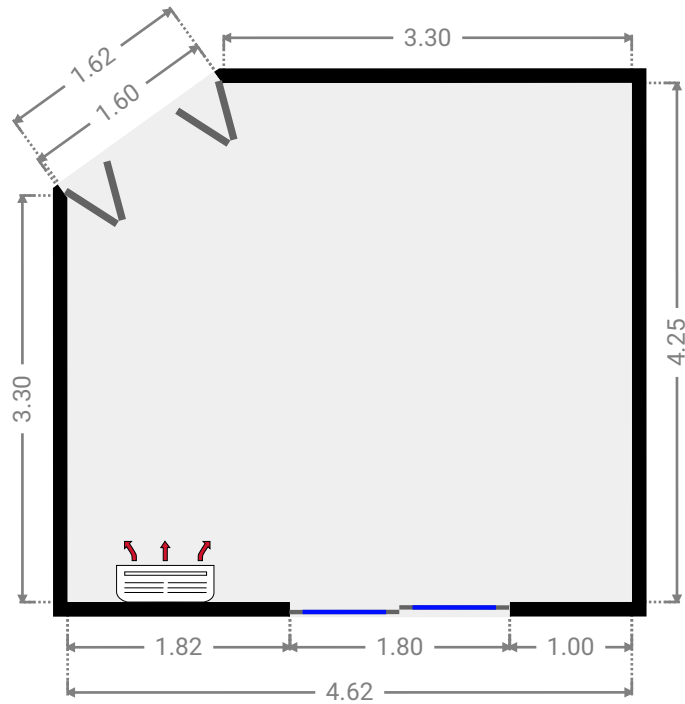
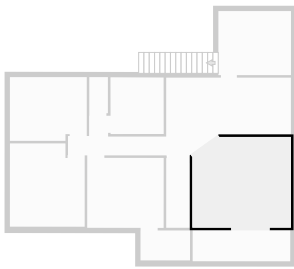

▼ **Other**  
1st Floor

WIDTH:4.57 m · LENGTH:1.46 m  
AREA:6.66 m<sup>2</sup> · PERIMETER:12.06 m

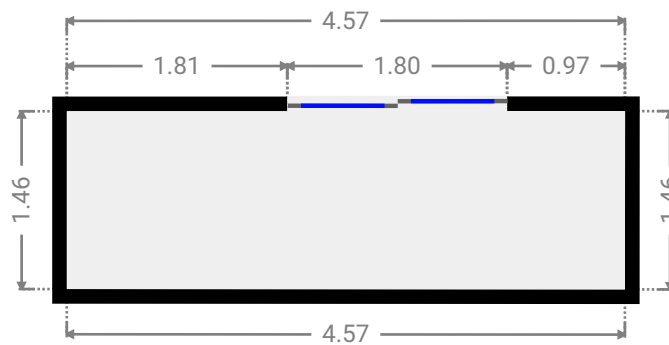
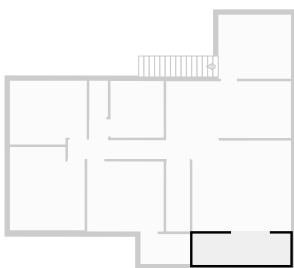

▼ Kitchen  
1st Floor

WIDTH:5.83 m · LENGTH:3.83 m  
AREA:17.53 m<sup>2</sup> · PERIMETER:18.80 m

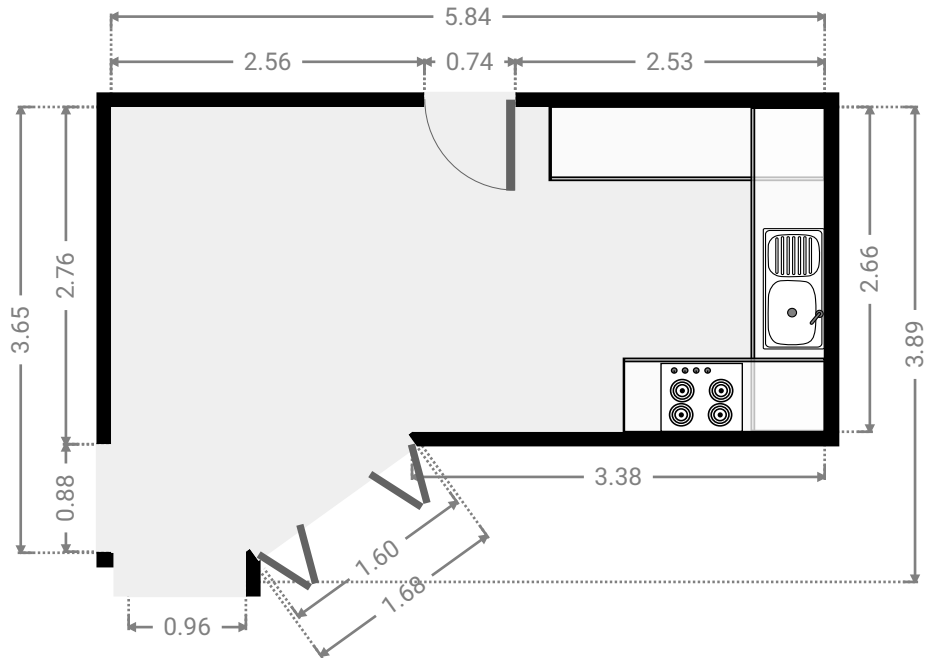
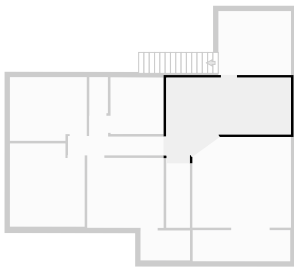

▼ Other  
1st Floor

WIDTH:3.40 m · LENGTH:3.00 m  
AREA:10.20 m<sup>2</sup> · PERIMETER:12.80 m

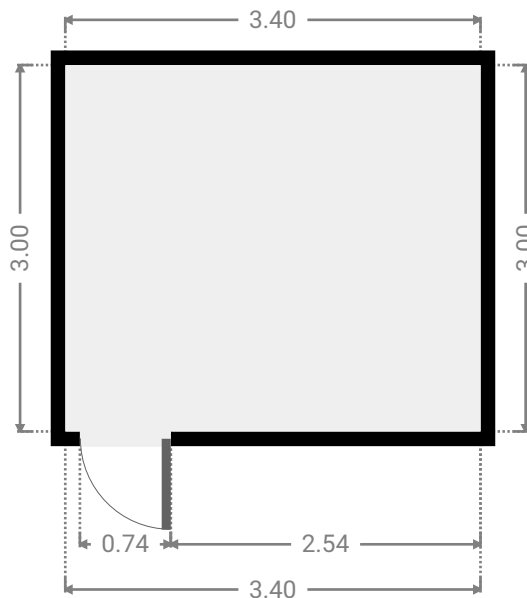
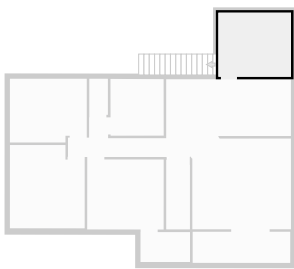

▼ **Hall**  
1st Floor

WIDTH:4.48 m · LENGTH:1.86 m  
AREA:4.84 m<sup>2</sup> · PERIMETER:12.67 m

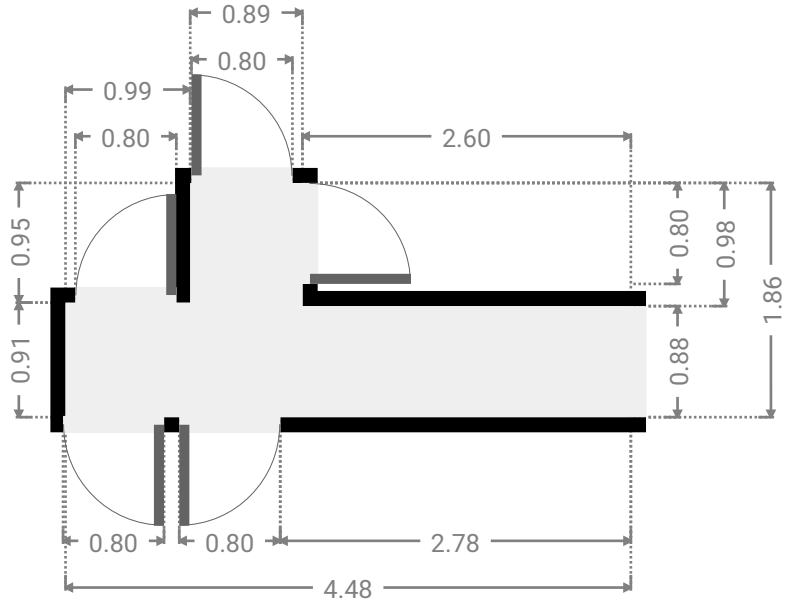
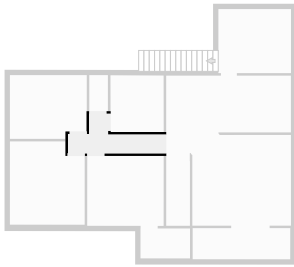

▼ **Bedroom**  
1st Floor

WIDTH:3.58 m · LENGTH:3.28 m  
AREA:11.73 m<sup>2</sup> · PERIMETER:13.72 m

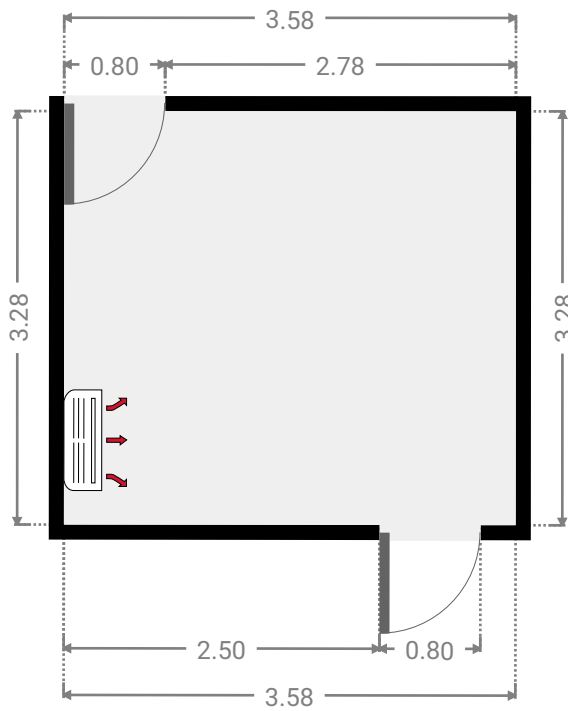
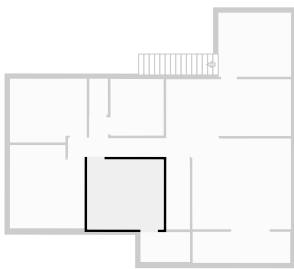

▼ **Closet**  
1st Floor

WIDTH:2.32 m · LENGTH:1.40 m  
AREA:3.25 m<sup>2</sup> · PERIMETER:7.44 m

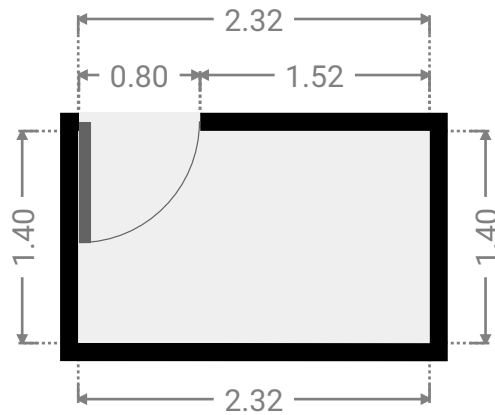
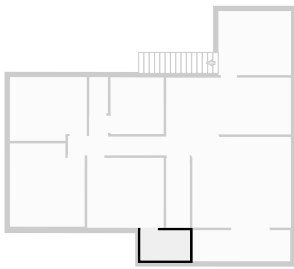

▼ **Stairway**  
1st Floor

WIDTH:1.11 m · LENGTH:3.25 m  
AREA:3.37 m<sup>2</sup> · PERIMETER:8.75 m

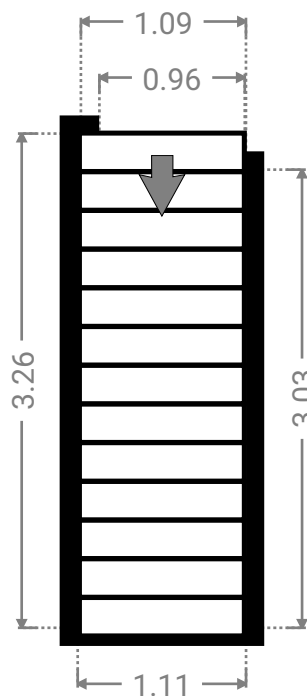
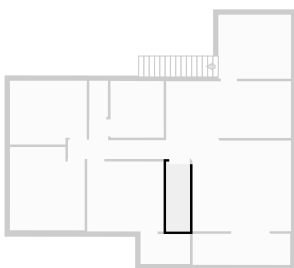

▼ **Bedroom**  
1st Floor

WIDTH:3.50 m · LENGTH:3.90 m  
AREA:13.05 m<sup>2</sup> · PERIMETER:14.81 m

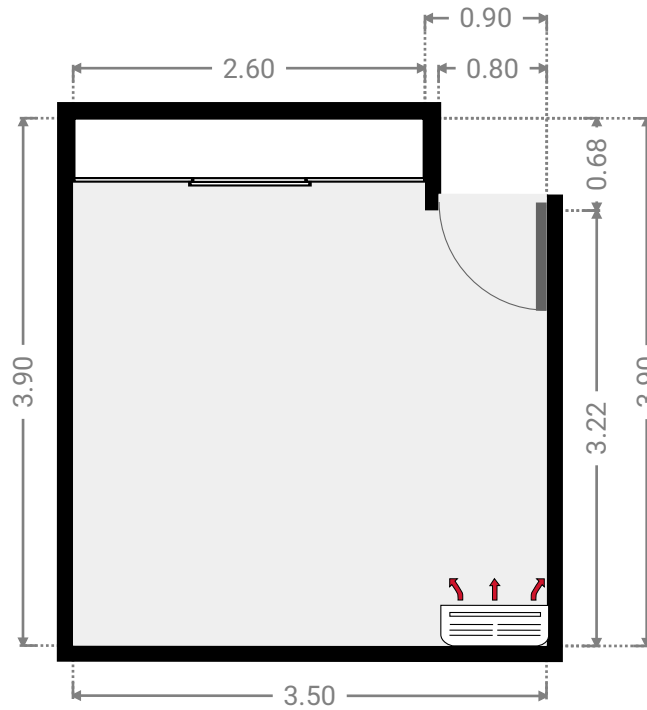
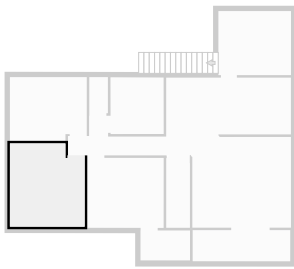

▼ **Bedroom**  
1st Floor

WIDTH:3.60 m · LENGTH:2.99 m  
AREA:10.43 m<sup>2</sup> · PERIMETER:13.17 m

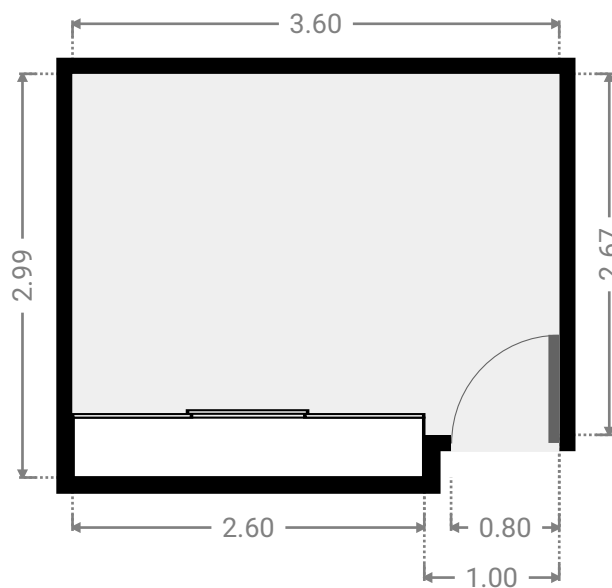
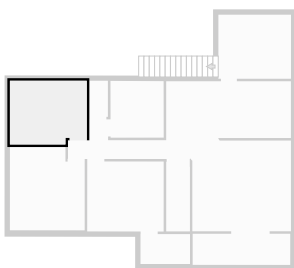

▼ Toilet  
1st Floor

WIDTH:0.87 m · LENGTH:1.69 m  
AREA:1.47 m<sup>2</sup> · PERIMETER:5.12 m

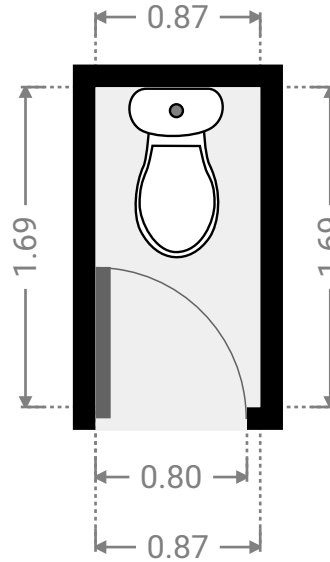
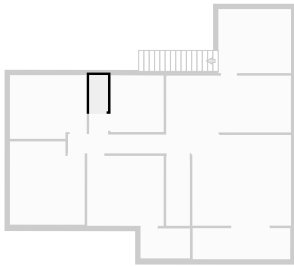

▼ Bathroom  
1st Floor

WIDTH:2.49 m · LENGTH:2.66 m  
AREA:6.60 m<sup>2</sup> · PERIMETER:10.28 m

