

# 361 Thozet Road

## Ground Floor

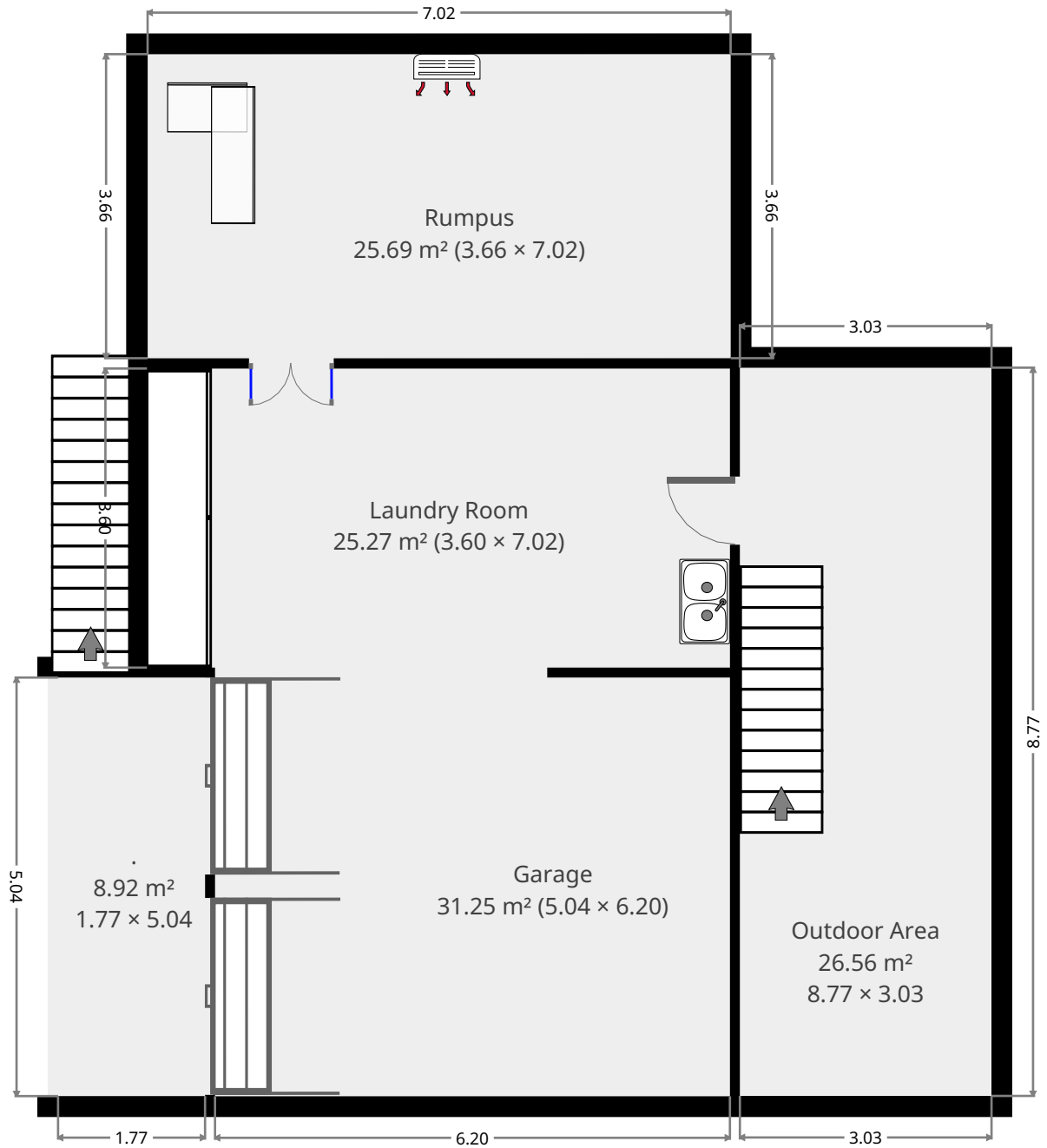

THIS FLOORPLAN IS PROVIDED WITHOUT WARRANTY OF ANY KIND. SENSOPIA DISCLAIMS ANY WARRANTY INCLUDING, WITHOUT LIMITATION, SATISFACTORY QUALITY OR ACCURACY OF DIMENSIONS.



# 361 Thozet Road

## Garage

Width: 5.04 m  
 Length: 6.20 m  
 Area: 31.25 m<sup>2</sup>  
 Perimeter: 22.48 m

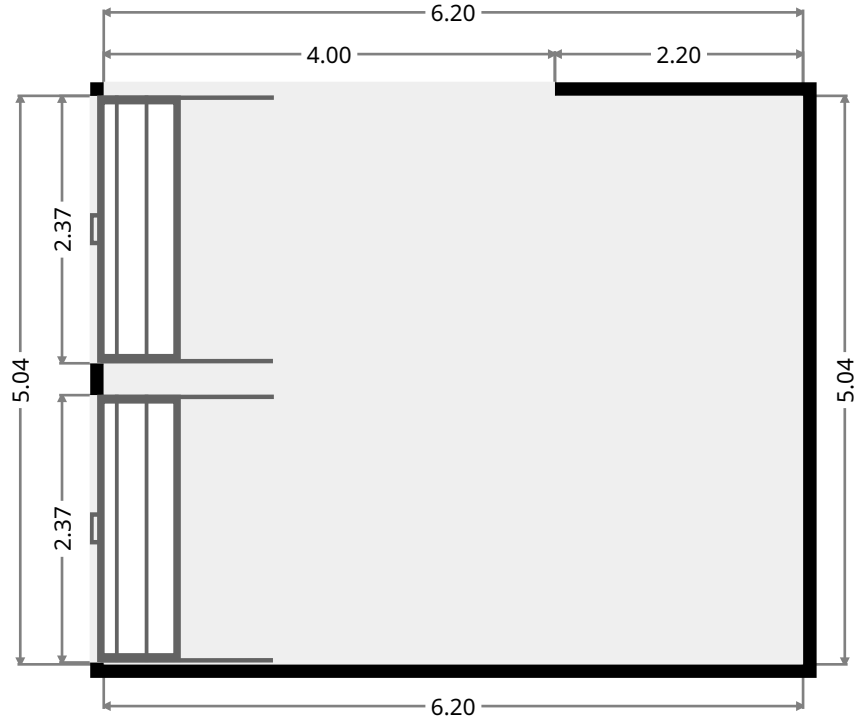
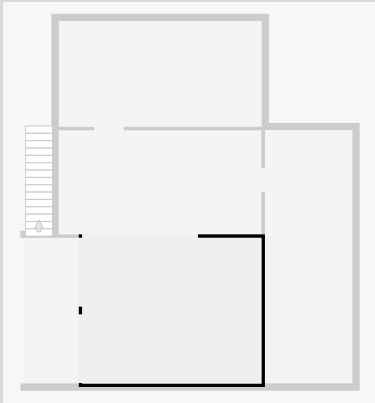

## Laundry Room

Width: 3.60 m  
 Length: 7.02 m  
 Area: 25.27 m<sup>2</sup>  
 Perimeter: 21.24 m

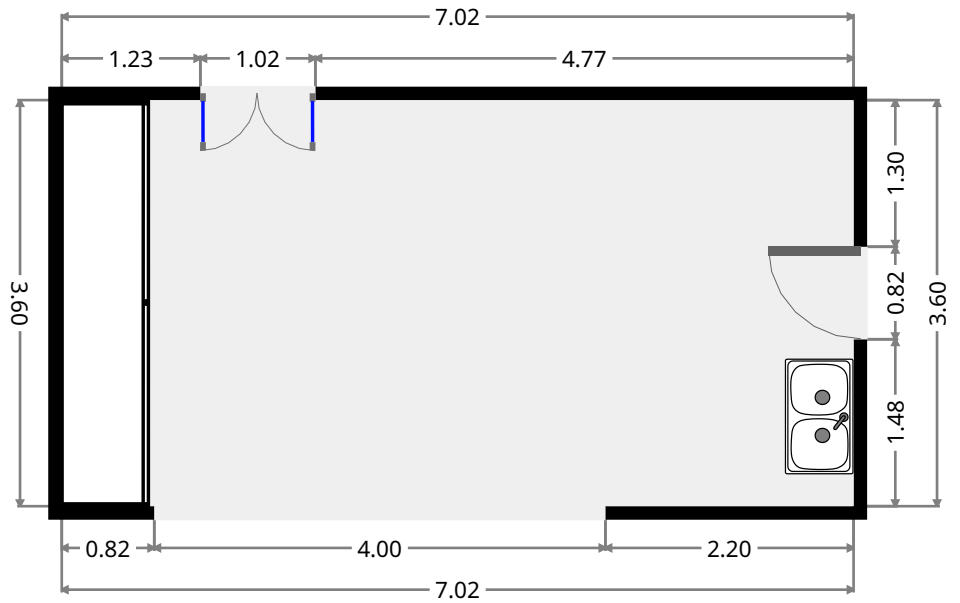
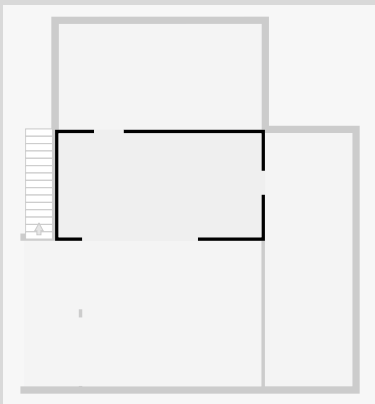

THIS FLOORPLAN IS PROVIDED WITHOUT WARRANTY OF ANY KIND. SENSOPIA DISCLAIMS ANY WARRANTY INCLUDING, WITHOUT LIMITATION, SATISFACTORY QUALITY OR ACCURACY OF DIMENSIONS.

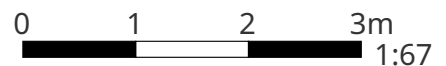

# 361 Thozet Road

## Outdoor Area

Width: 3.03 m  
 Length: 8.77 m  
 Area: 26.56 m<sup>2</sup>  
 Perimeter: 23.59 m

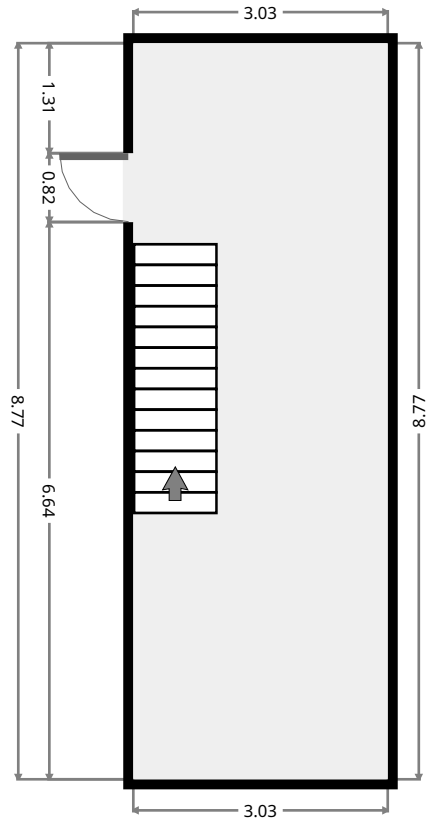
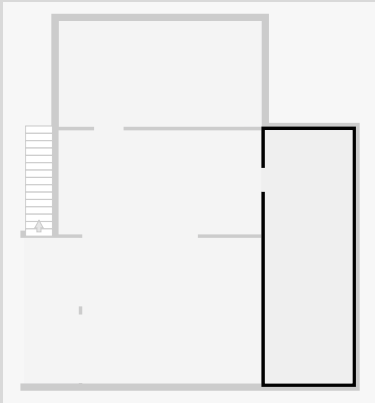

## Rumpus

Width: 3.66 m  
 Length: 7.02 m  
 Area: 25.69 m<sup>2</sup>  
 Perimeter: 21.36 m

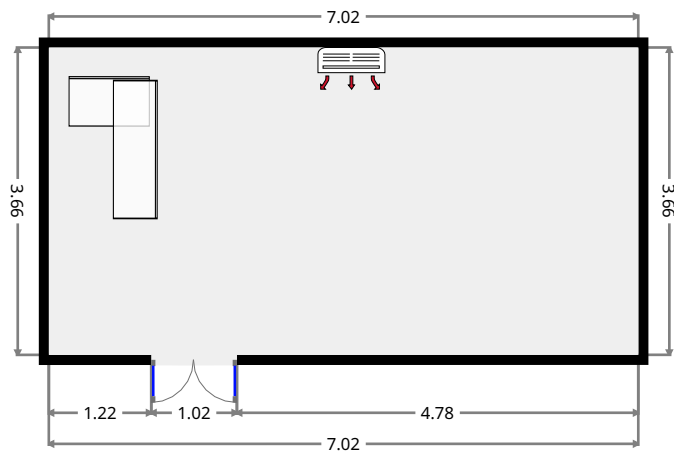
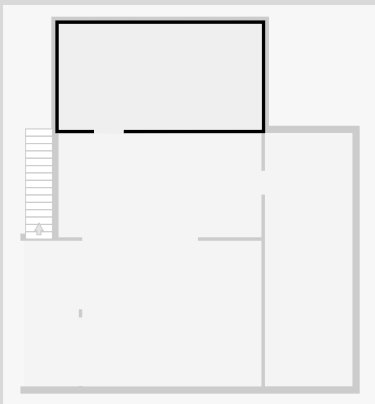

# 361 Thozet Road

•  
Width: 1.77 m  
Length: 5.04 m  
Area: 8.92 m<sup>2</sup>  
Perimeter: 13.62 m

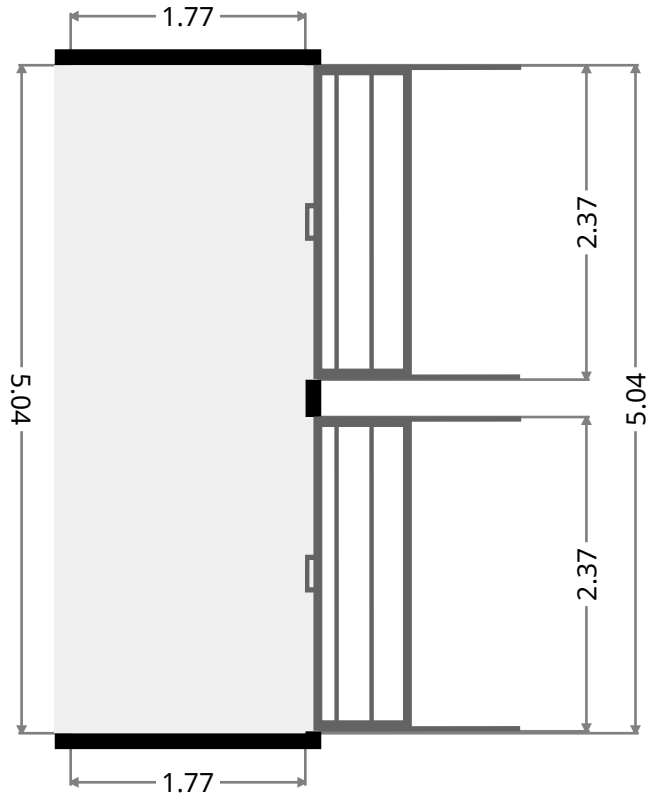
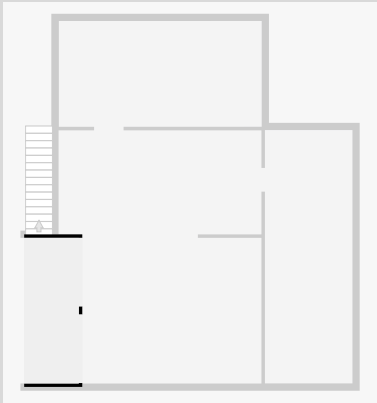

# 361 Thozet Road

## 1st Floor

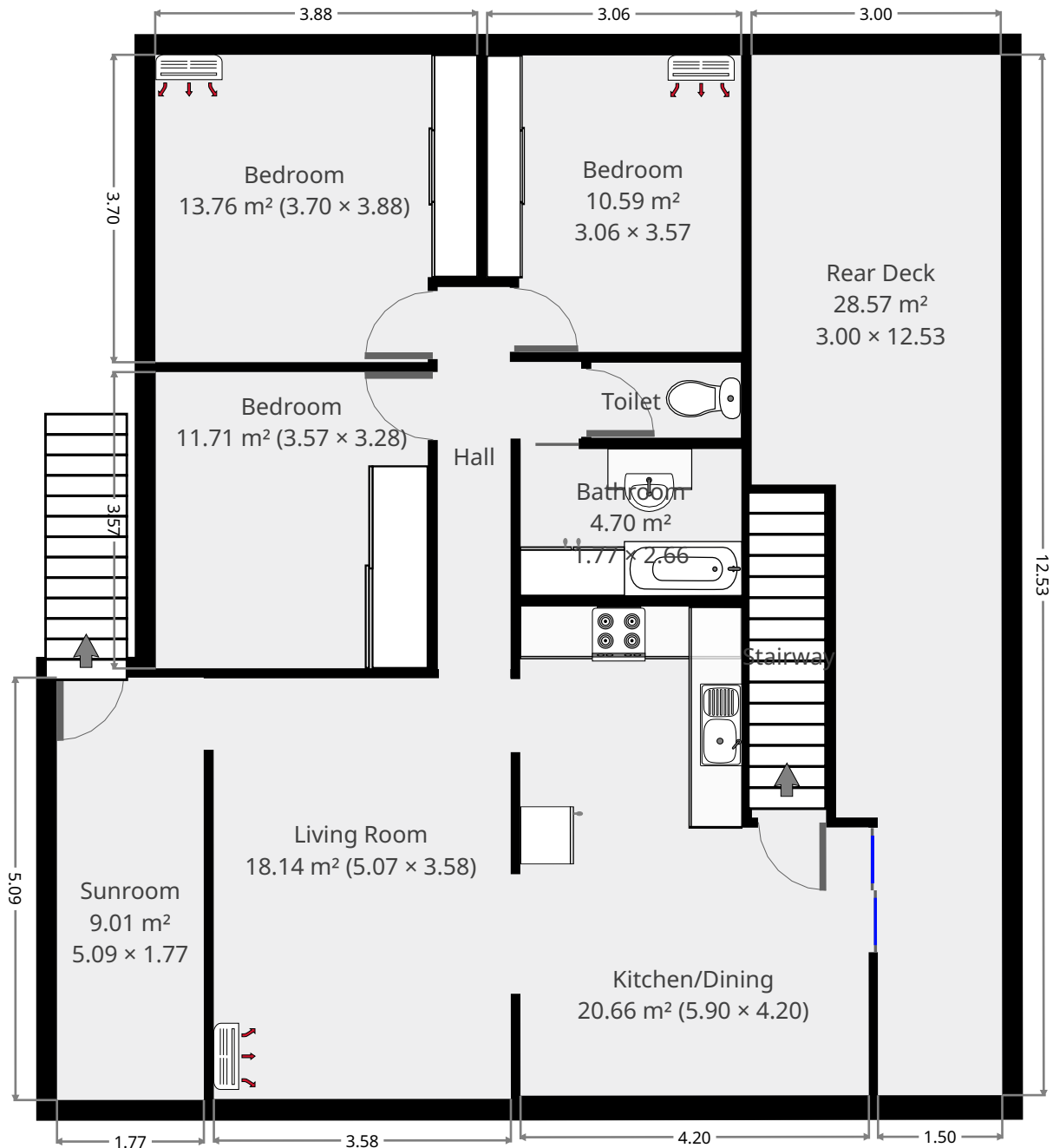

THIS FLOORPLAN IS PROVIDED WITHOUT WARRANTY OF ANY KIND. SENSOPIA DISCLAIMS ANY WARRANTY INCLUDING, WITHOUT LIMITATION, SATISFACTORY QUALITY OR ACCURACY OF DIMENSIONS.



# 361 Thozet Road

## Sunroom

Width: 1.77 m  
 Length: 5.09 m  
 Area: 9.01 m<sup>2</sup>  
 Perimeter: 13.72 m

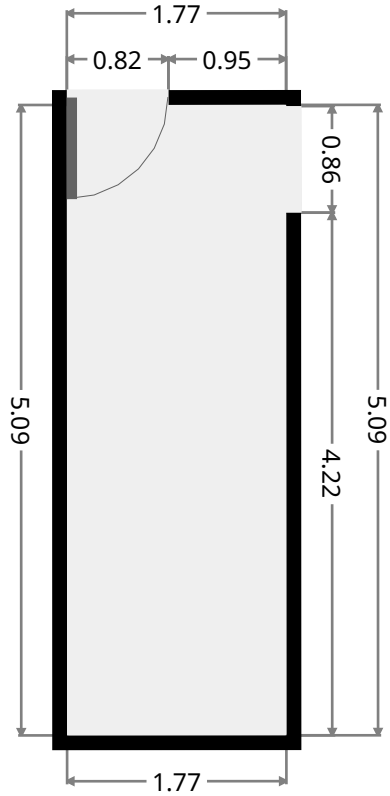
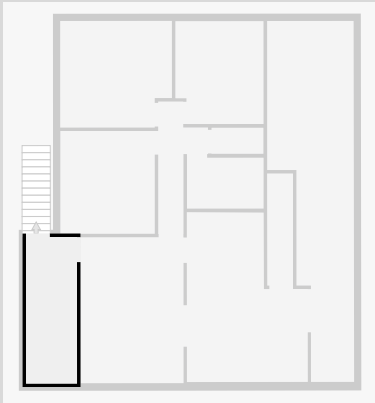

## Living Room

Width: 3.58 m  
 Length: 5.07 m  
 Area: 18.14 m<sup>2</sup>  
 Perimeter: 17.29 m

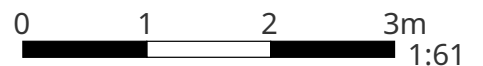
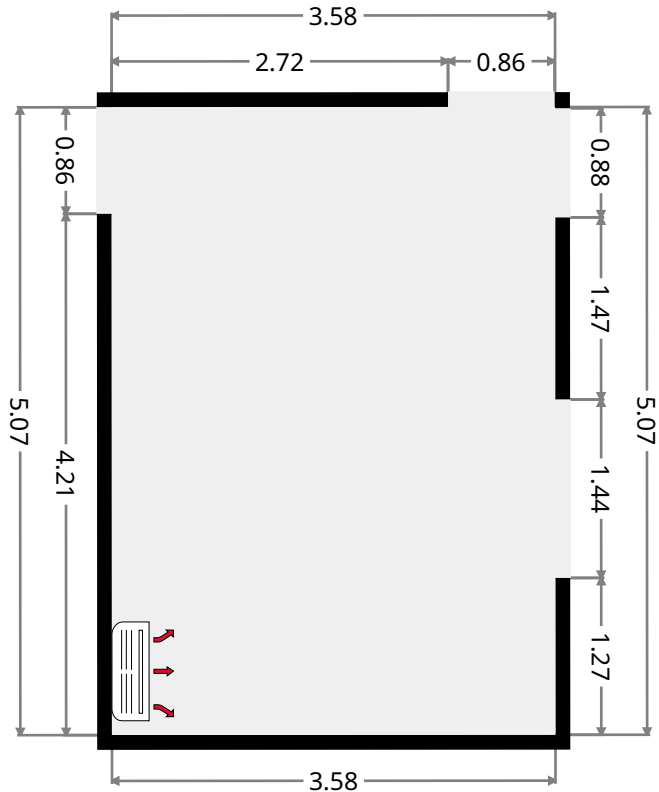
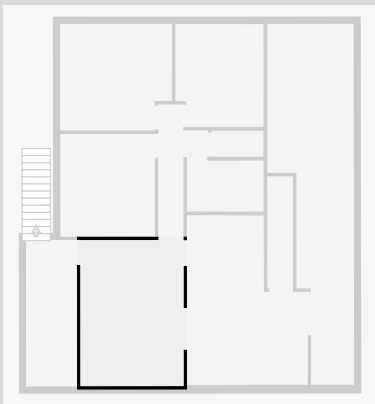

THIS FLOORPLAN IS PROVIDED WITHOUT WARRANTY OF ANY KIND. SENSOPIA DISCLAIMS ANY WARRANTY INCLUDING, WITHOUT LIMITATION, SATISFACTORY QUALITY OR ACCURACY OF DIMENSIONS.

# 361 Thozet Road

## Hall

Width: 1.73 m  
 Length: 4.60 m  
 Area: 4.81 m<sup>2</sup>  
 Perimeter: 12.66 m

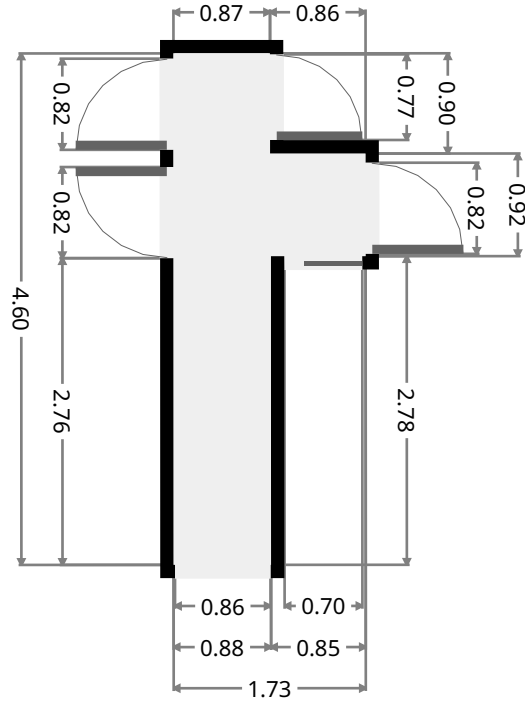
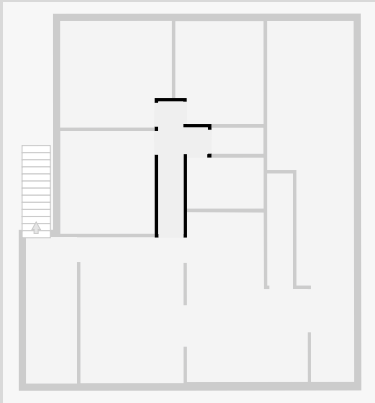

## Kitchen/Dining

Width: 4.20 m  
 Length: 5.90 m  
 Area: 20.66 m<sup>2</sup>  
 Perimeter: 20.17 m

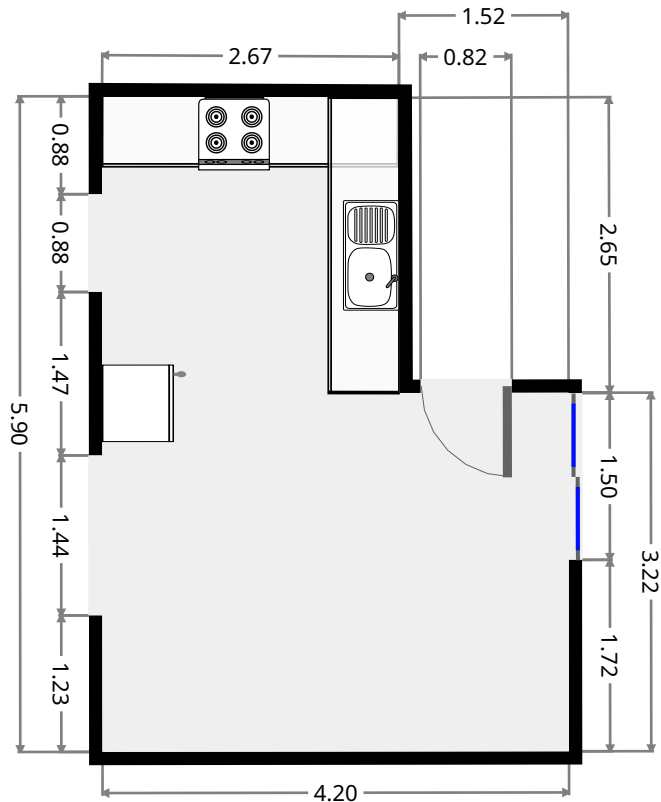
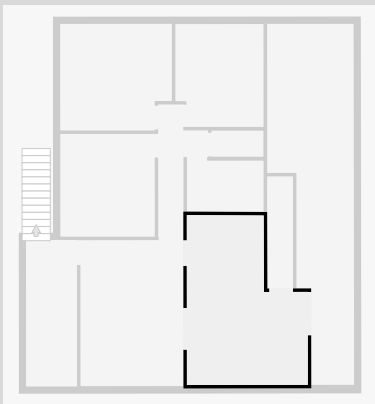

THIS FLOORPLAN IS PROVIDED WITHOUT WARRANTY OF ANY KIND. SENSOPIA DISCLAIMS ANY WARRANTY INCLUDING, WITHOUT LIMITATION, SATISFACTORY QUALITY OR ACCURACY OF DIMENSIONS.

# 361 Thozet Road

## Bedroom

Width: 3.28 m  
 Length: 3.57 m  
 Area: 11.71 m<sup>2</sup>  
 Perimeter: 13.70 m

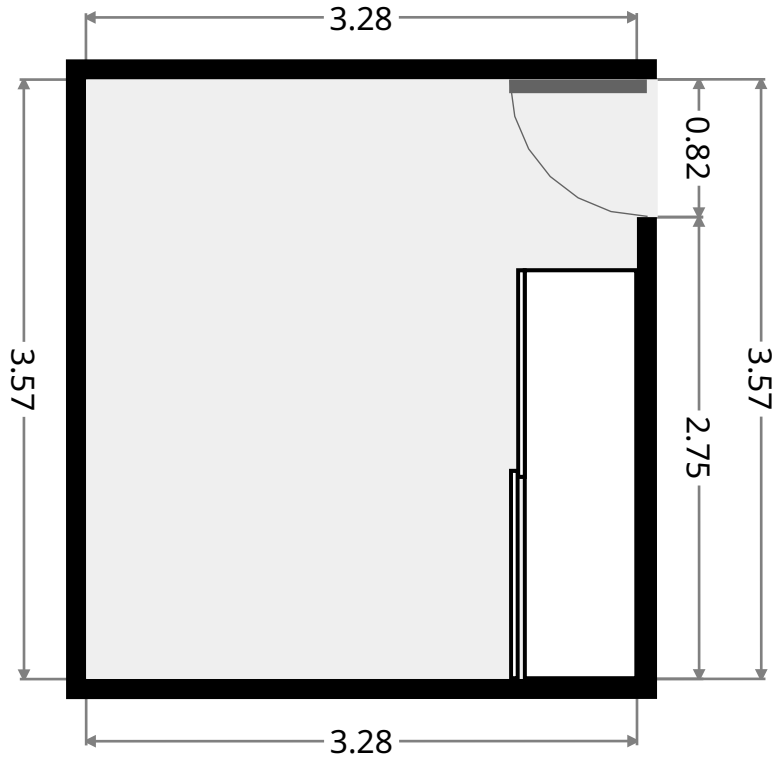
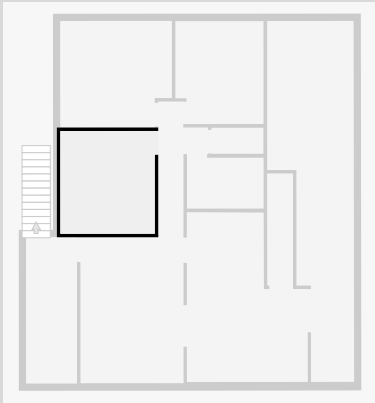

## Bedroom

Width: 3.70 m  
 Length: 3.88 m  
 Area: 13.76 m<sup>2</sup>  
 Perimeter: 15.17 m

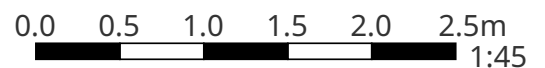
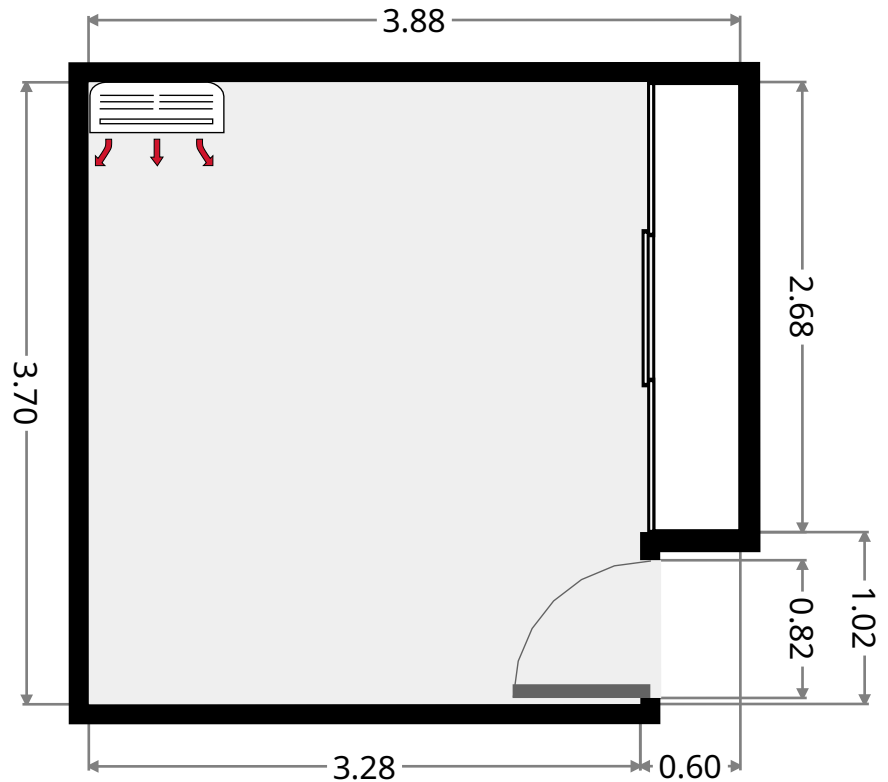
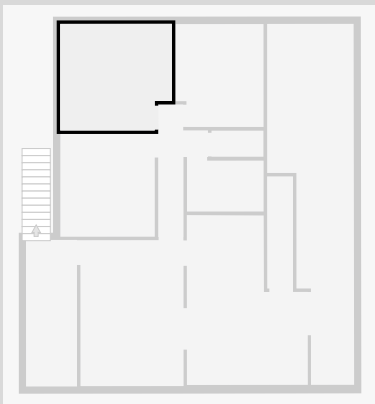

THIS FLOORPLAN IS PROVIDED WITHOUT WARRANTY OF ANY KIND. SENSOPIA DISCLAIMS ANY WARRANTY INCLUDING, WITHOUT LIMITATION, SATISFACTORY QUALITY OR ACCURACY OF DIMENSIONS.



# 361 Thozet Road

## Bedroom

Width: 3.06 m  
Length: 3.57 m  
Area: 10.59 m<sup>2</sup>  
Perimeter: 13.27 m

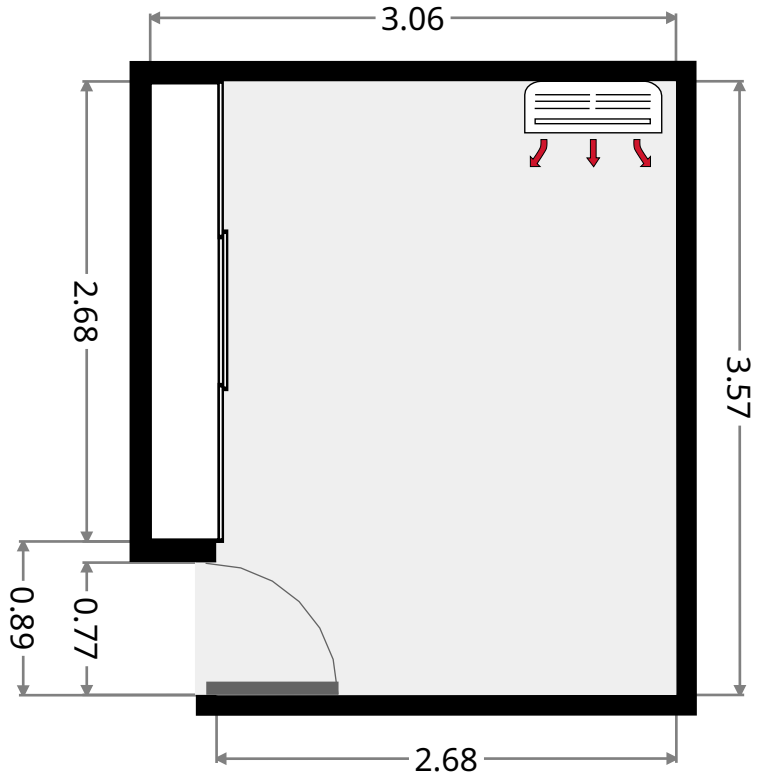
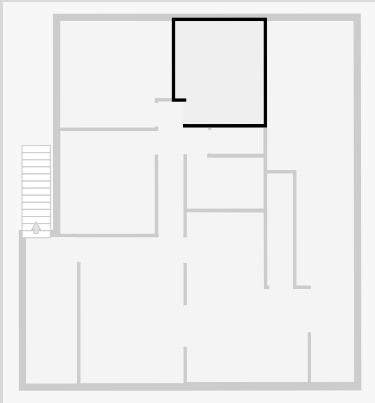

## Toilet

Width: 0.90 m  
Length: 1.80 m  
Area: 1.63 m<sup>2</sup>  
Perimeter: 5.41 m

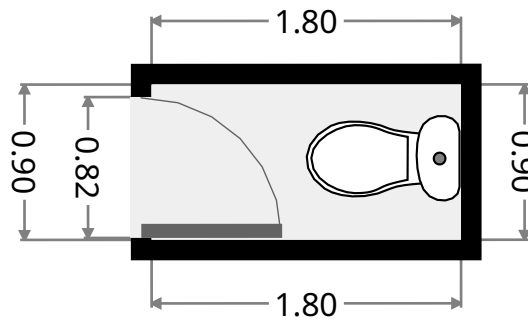
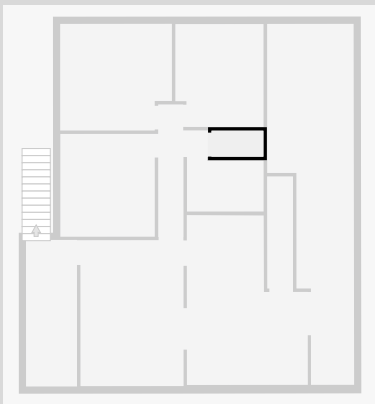

# 361 Thozet Road

## Bathroom

Width: 1.77 m  
Length: 2.66 m  
Area: 4.70 m<sup>2</sup>  
Perimeter: 8.85 m

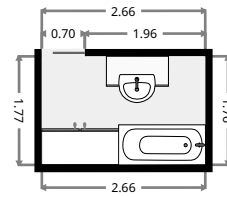
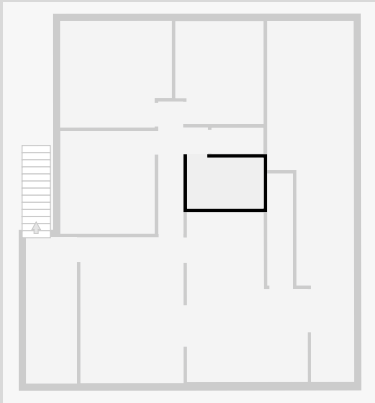

## Rear Deck

Width: 3.00 m  
Length: 12.53 m  
Area: 28.57 m<sup>2</sup>  
Perimeter: 31.09 m

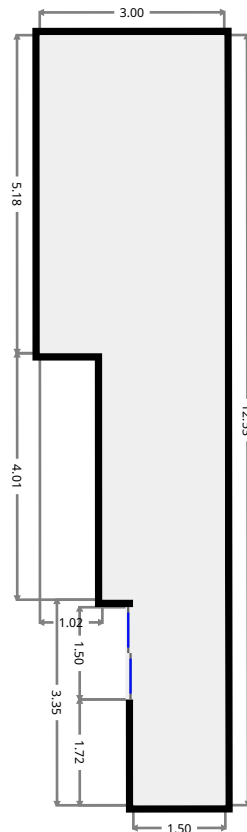
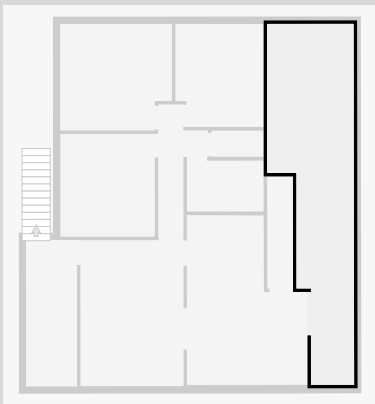

# 361 Thozet Road

## Stairway

Width:	0.89 m
Length:	3.89 m
Area	3.49 m <sup>2</sup>
Perimeter	9.58 m

