

36 Julie Crescent

Created on
2020-12-03

Floors
2

▼ Ground Floor

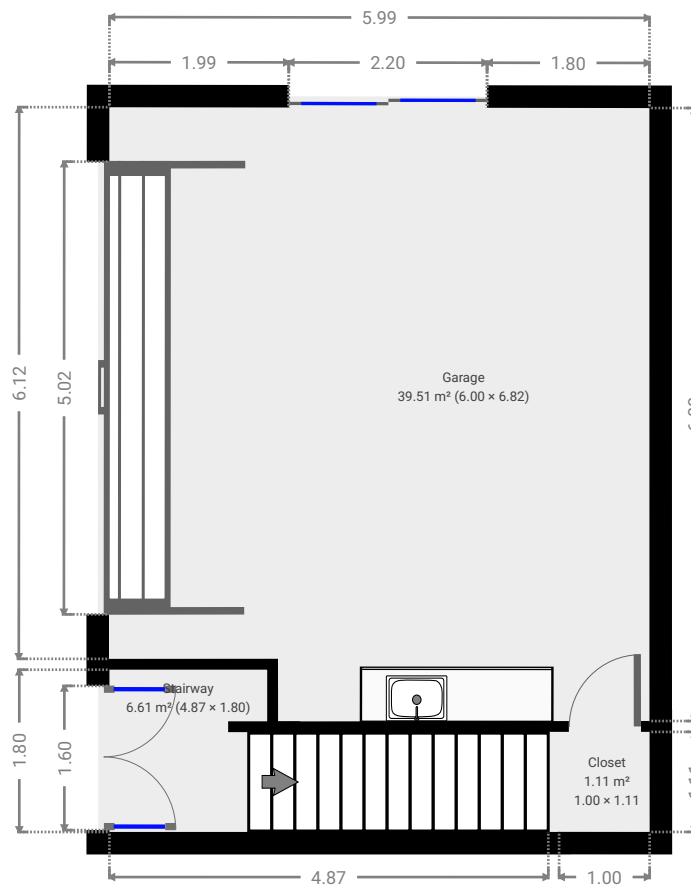

FLOORS:2

▼ **Garage**
Ground Floor

WIDTH:6.82 m · LENGTH:6.00 m
AREA:39.51 m² · PERIMETER:25.60 m

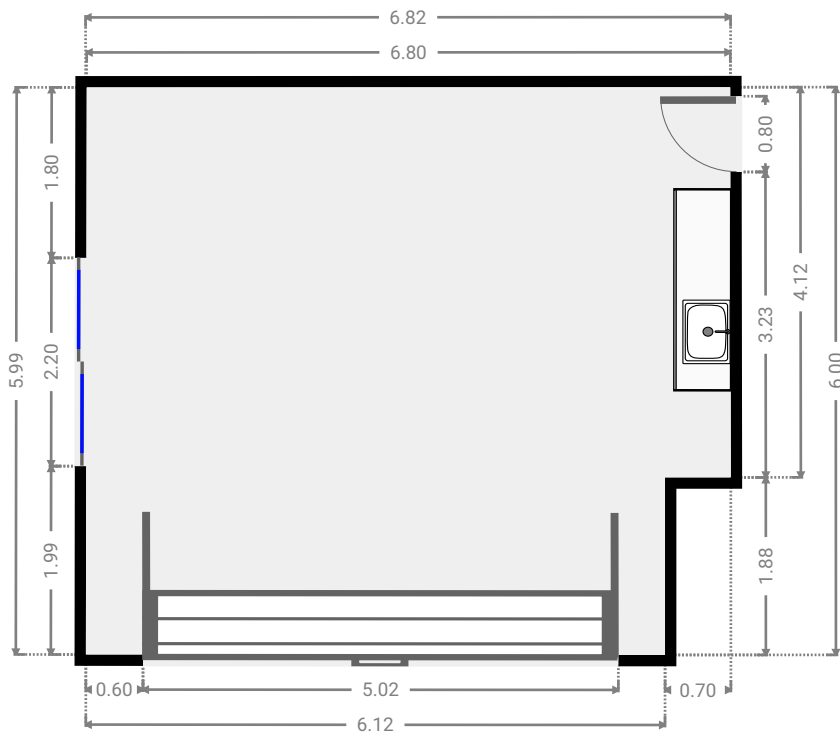
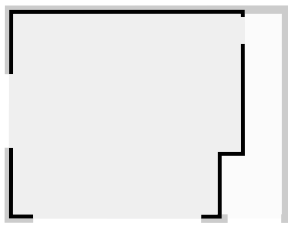

▼ **Stairway**
Ground Floor

WIDTH:1.80 m · LENGTH:4.87 m
AREA:6.61 m² · PERIMETER:13.34 m

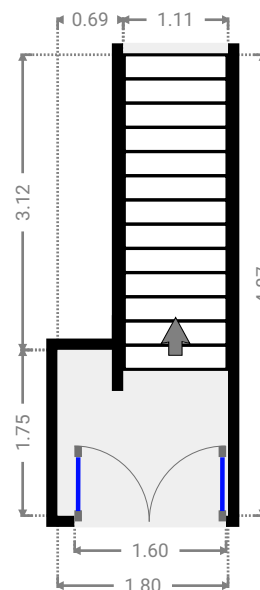
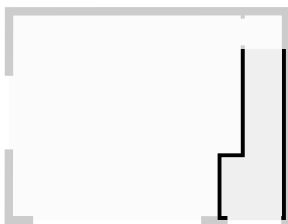

▼ Closet
Ground Floor

WIDTH:1.11 m · LENGTH:1.00 m
AREA:1.11 m² · PERIMETER:4.23 m

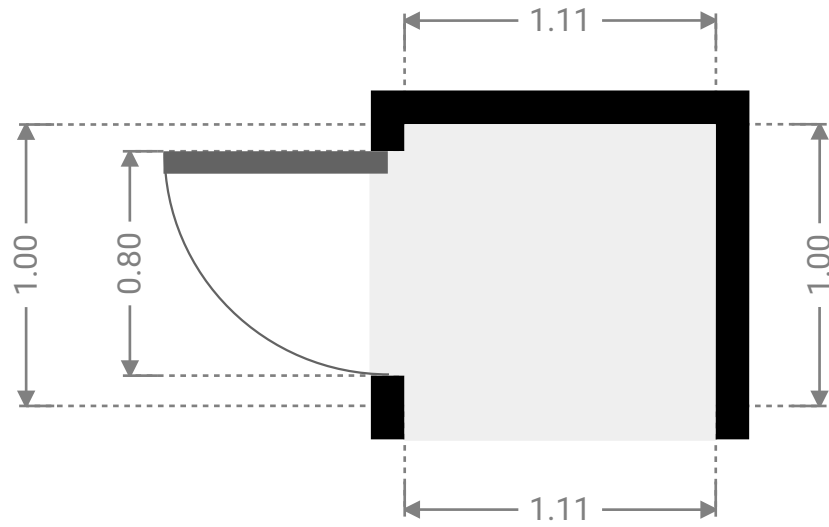
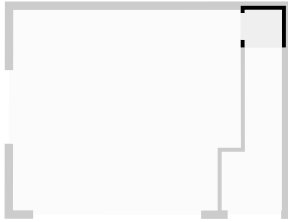

▼ 1st Floor

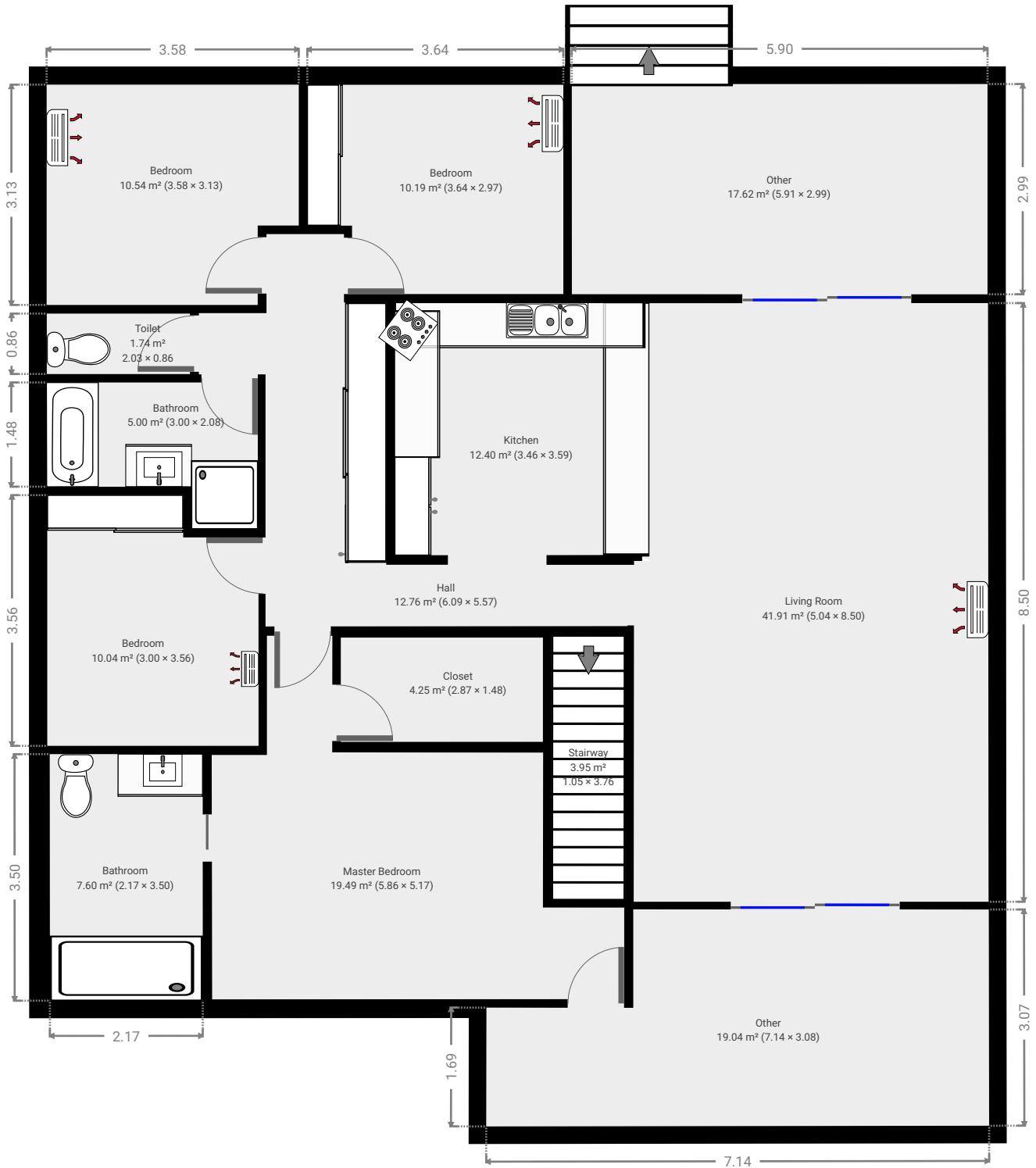

▼ Living Room
1st Floor

WIDTH:5.04 m · LENGTH:8.50 m
AREA:41.91 m² · PERIMETER:27.06 m

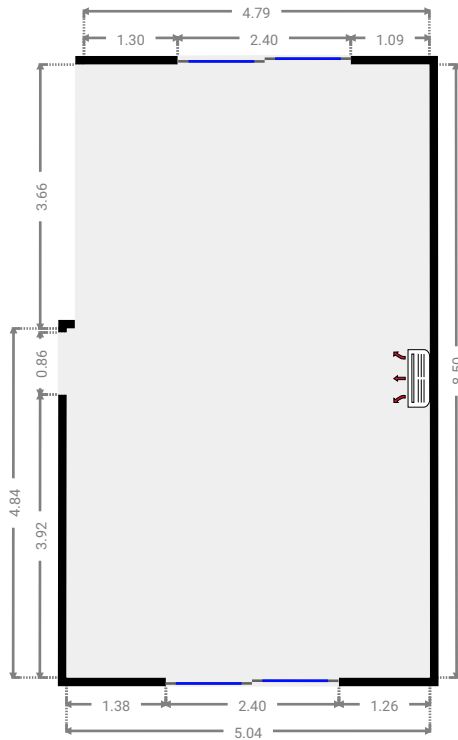
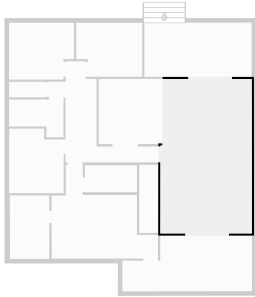

▼ Hall
1st Floor

WIDTH:6.09 m · LENGTH:5.57 m
AREA:12.76 m² · PERIMETER:23.31 m

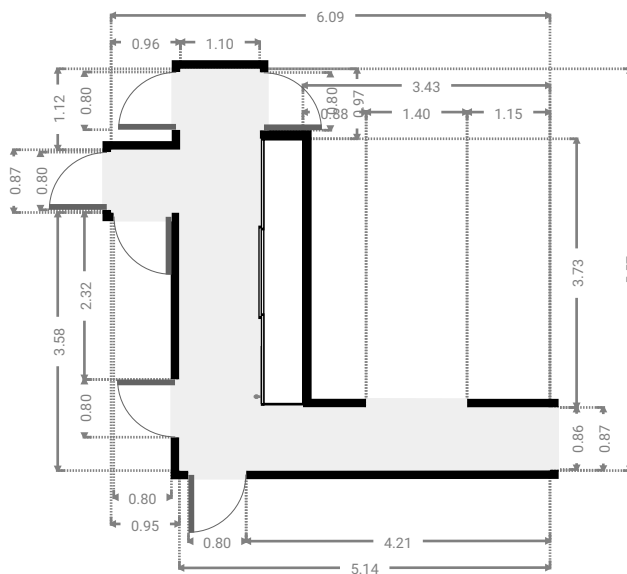
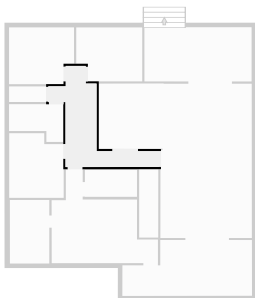

▼ Kitchen
1st Floor

WIDTH:3.46 m · LENGTH:3.59 m
AREA:12.40 m² · PERIMETER:14.07 m

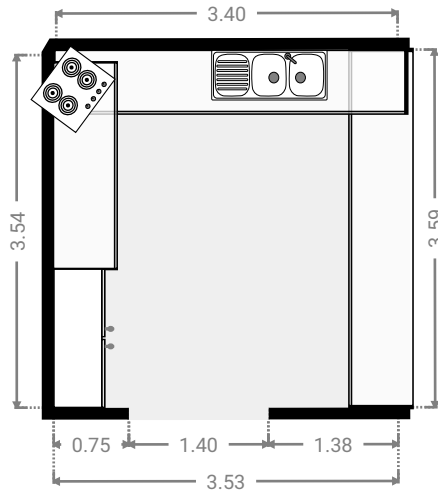
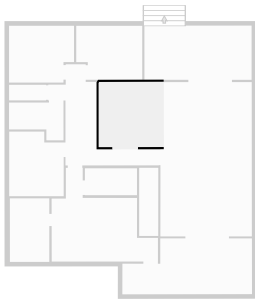

▼ Master Bedroom
1st Floor

WIDTH:5.86 m · LENGTH:5.17 m
AREA:19.49 m² · PERIMETER:22.03 m

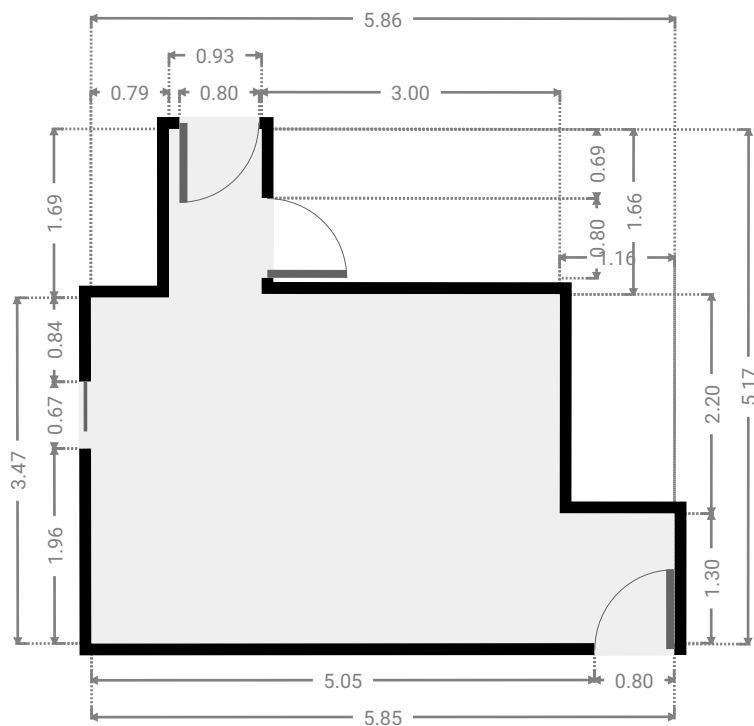
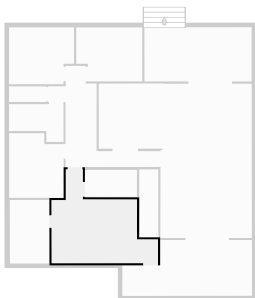

▼ **Closet**
1st Floor

WIDTH:2.87 m · LENGTH:1.48 m
AREA:4.25 m² · PERIMETER:8.70 m

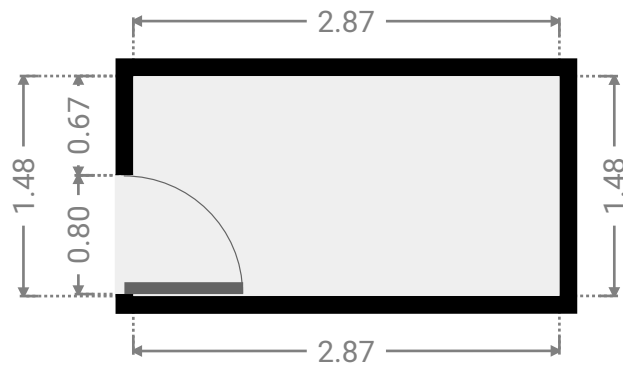
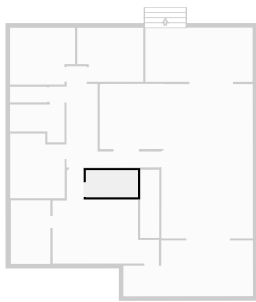

▼ **Stairway**
1st Floor

WIDTH:1.05 m · LENGTH:3.76 m
AREA:3.95 m² · PERIMETER:9.61 m

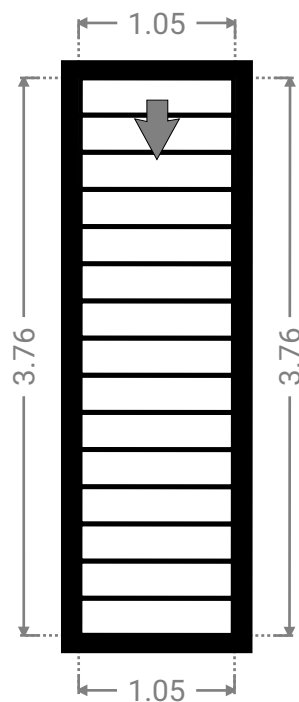
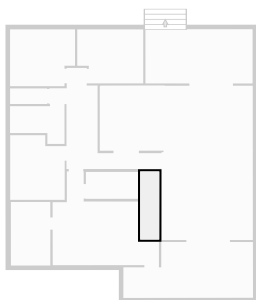

▼ Bathroom
1st Floor

WIDTH:2.17 m · LENGTH:3.50 m
AREA:7.60 m² · PERIMETER:11.34 m

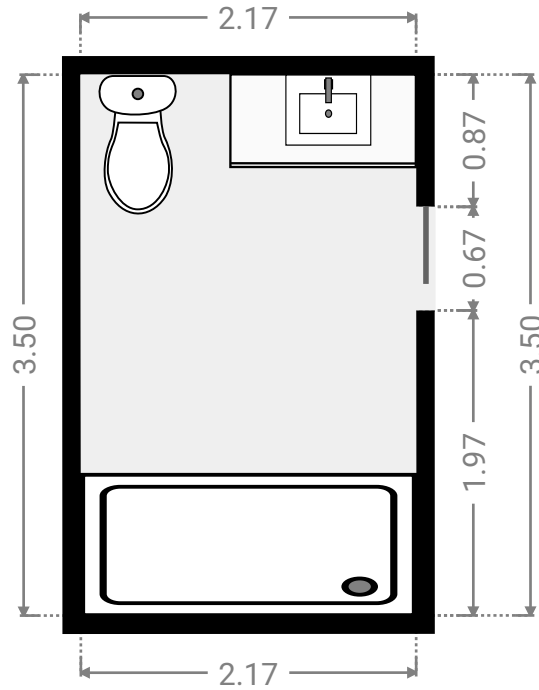
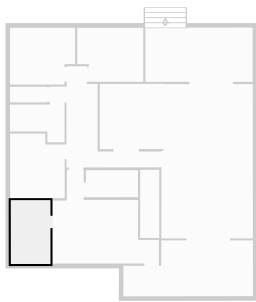

▼ Bedroom
1st Floor

WIDTH:3.00 m · LENGTH:3.56 m
AREA:10.04 m² · PERIMETER:13.12 m

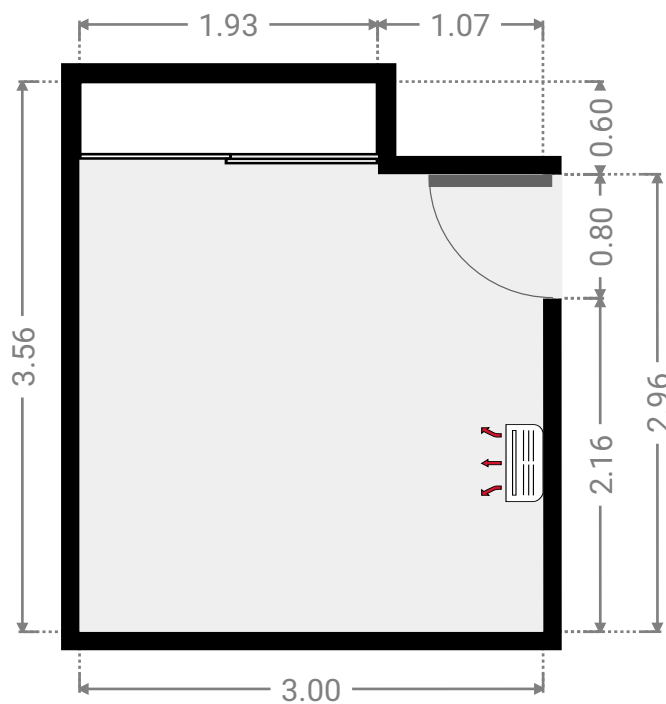
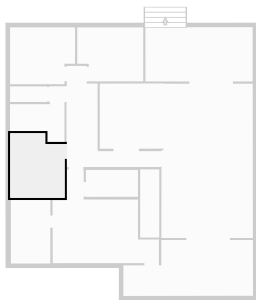

▼ Bathroom
1st Floor

WIDTH:3.00 m · LENGTH:2.08 m
AREA:5.00 m² · PERIMETER:10.16 m

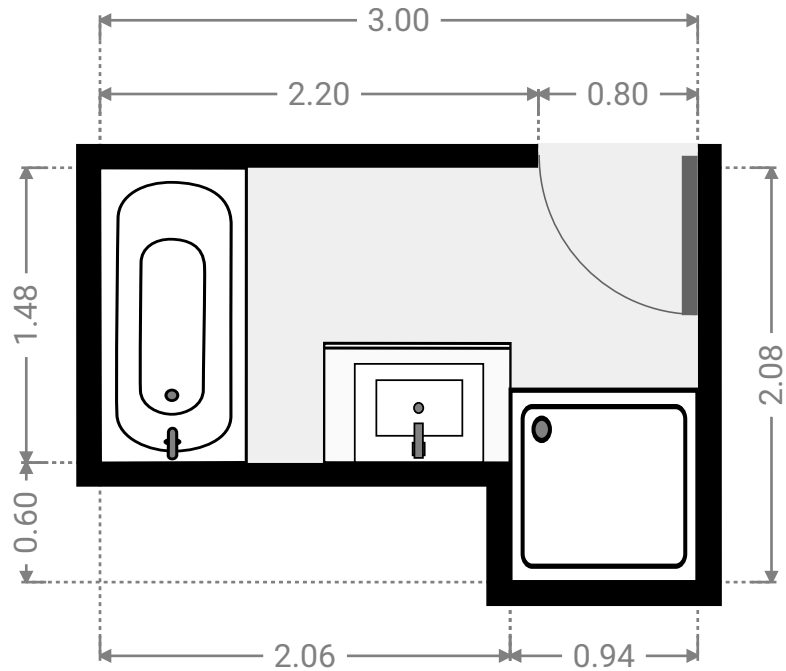
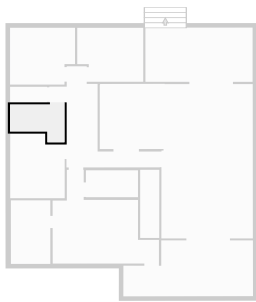

▼ Toilet
1st Floor

WIDTH:2.03 m · LENGTH:0.86 m
AREA:1.74 m² · PERIMETER:5.78 m

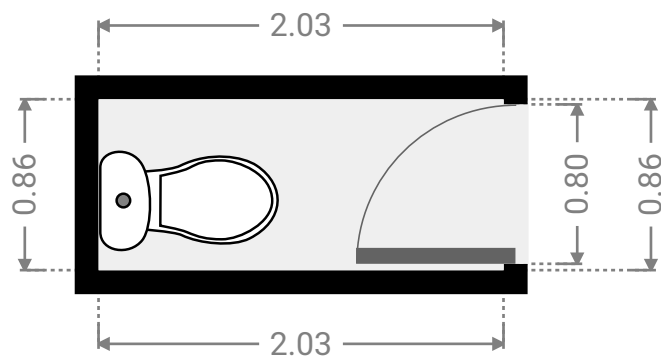
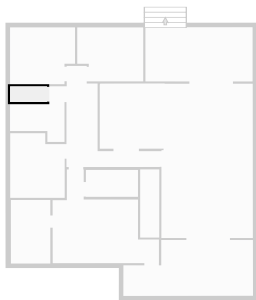

▼ **Bedroom**
1st Floor

WIDTH:3.58 m · LENGTH:3.13 m
AREA:10.54 m² · PERIMETER:13.42 m

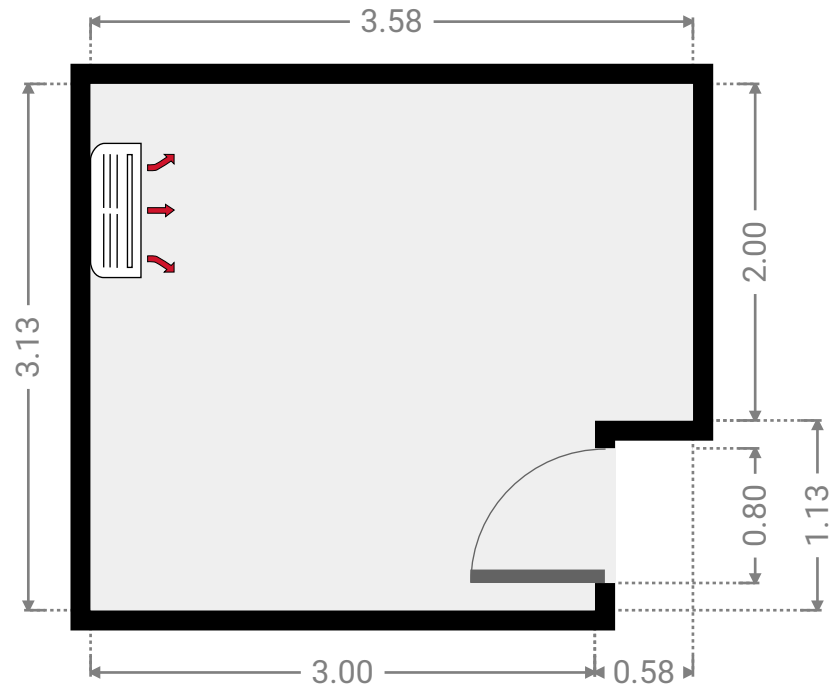
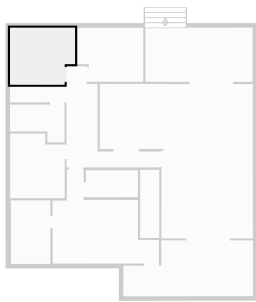

▼ **Bedroom**
1st Floor

WIDTH:3.64 m · LENGTH:2.97 m
AREA:10.19 m² · PERIMETER:13.21 m

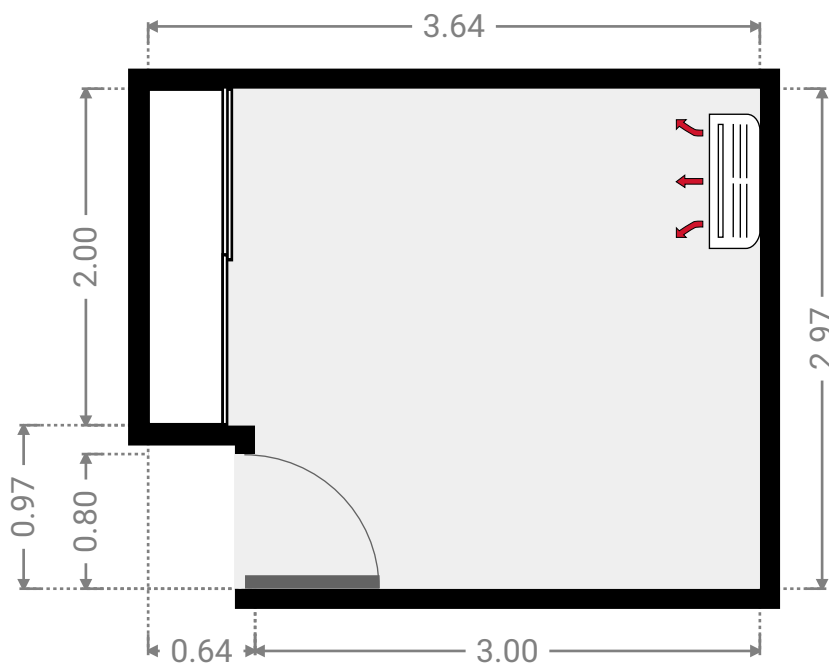
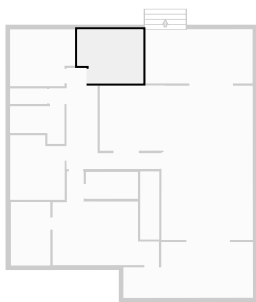

▼ Other
1st Floor

WIDTH:7.14 m · LENGTH:3.08 m
AREA:19.04 m² · PERIMETER:20.43 m

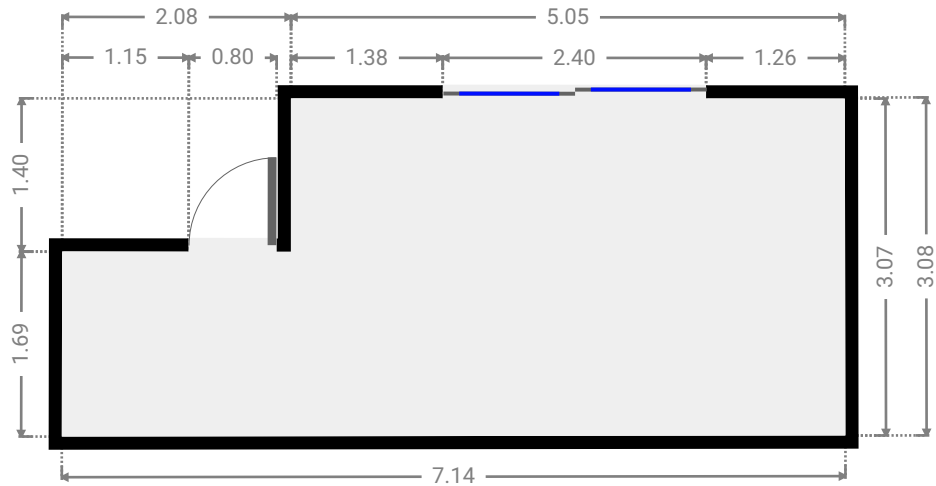
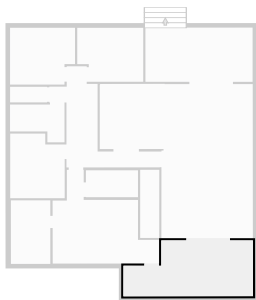

▼ Other
1st Floor

WIDTH:5.91 m · LENGTH:2.99 m
AREA:17.62 m² · PERIMETER:17.78 m

