

355 Philp Avenue

Created on
2021-08-17

Floors
2

▼ Ground Floor

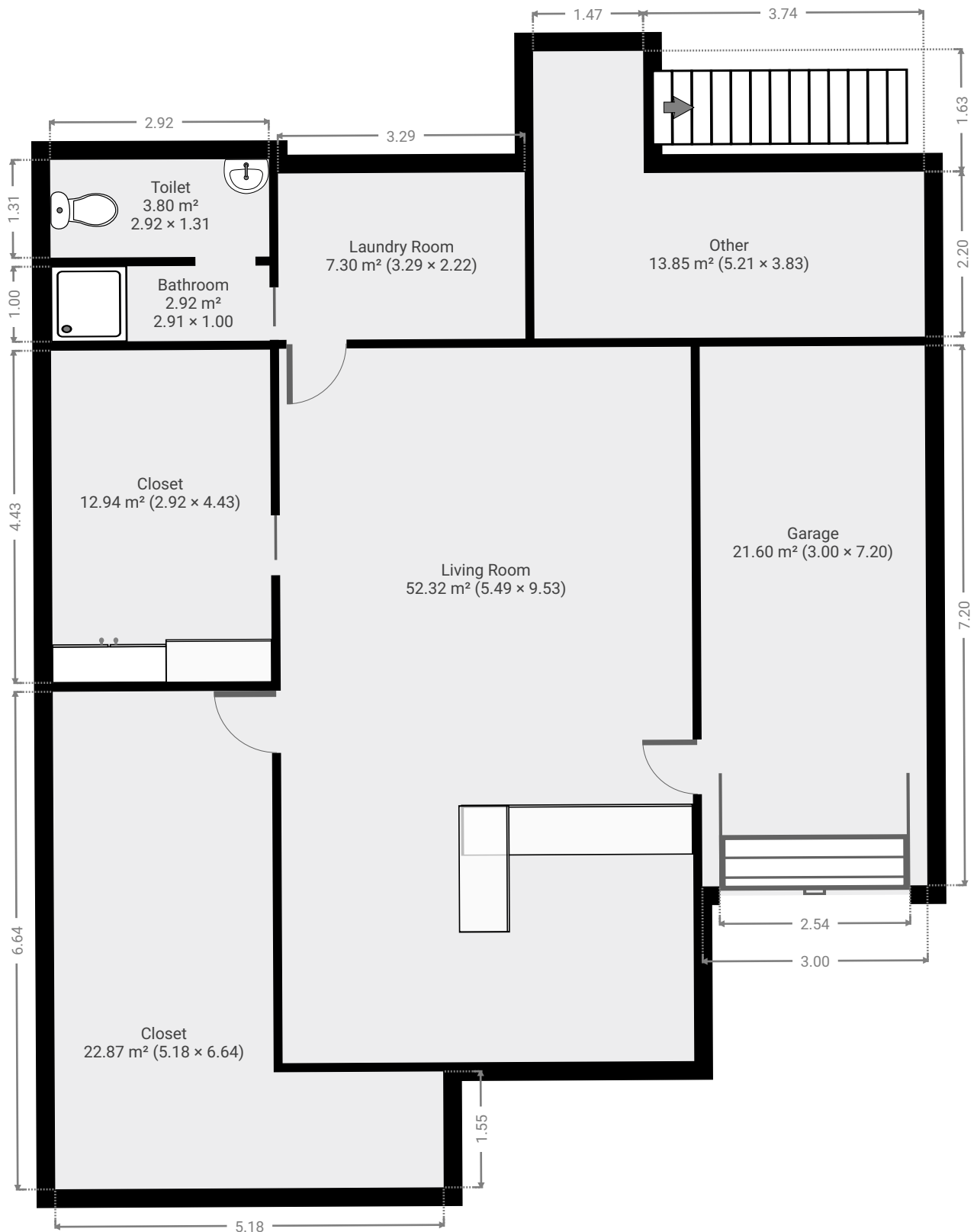

▼ **Living Room**
Ground Floor

WIDTH: 5.49 m • LENGTH: 9.53 m
AREA: 52.32 m² • PERIMETER: 30.04 m

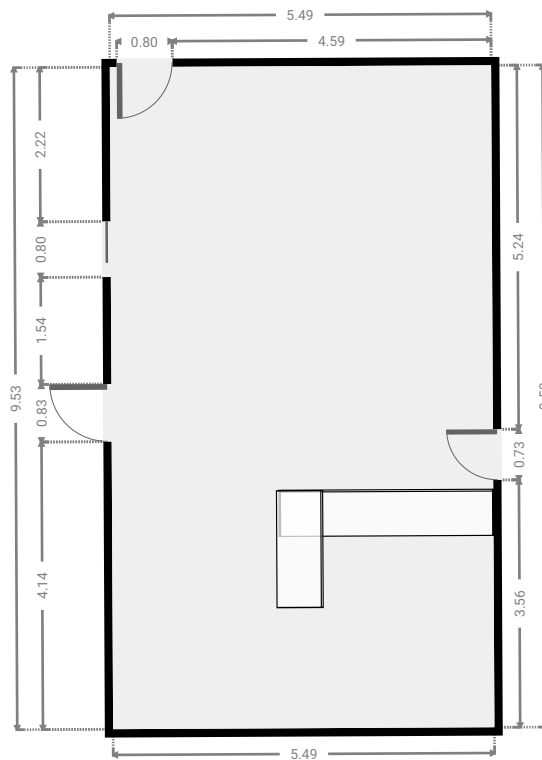
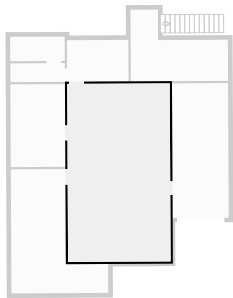

▼ **Closet**
Ground Floor

WIDTH: 5.18 m • LENGTH: 6.64 m
AREA: 22.87 m² • PERIMETER: 23.63 m

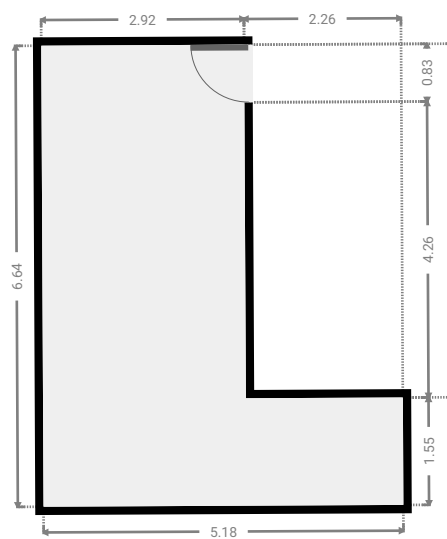
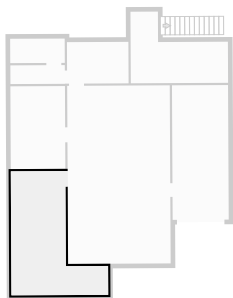

▼ **Closet**
Ground Floor

WIDTH: 2.92 m • LENGTH: 4.43 m
AREA: 12.94 m² • PERIMETER: 14.70 m

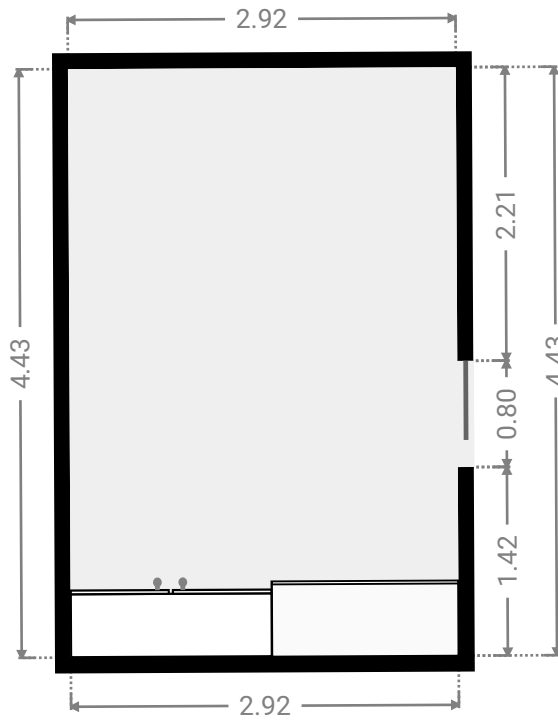
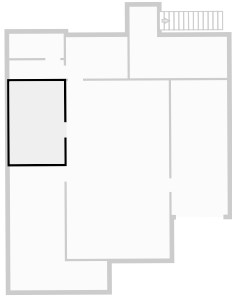

▼ **Laundry Room**
Ground Floor

WIDTH: 3.29 m • LENGTH: 2.22 m
AREA: 7.30 m² • PERIMETER: 11.02 m

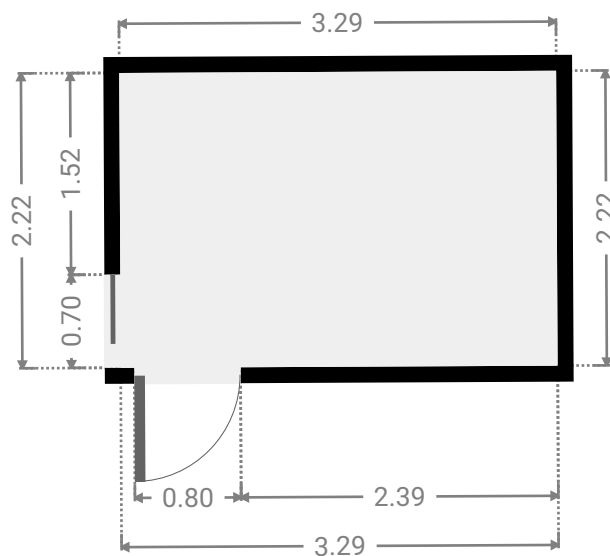
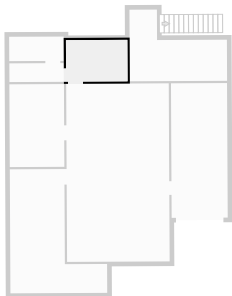

▼ **Bathroom**
Ground Floor

WIDTH: 2.92 m • LENGTH: 1.00 m
AREA: 2.92 m² • PERIMETER: 7.83 m

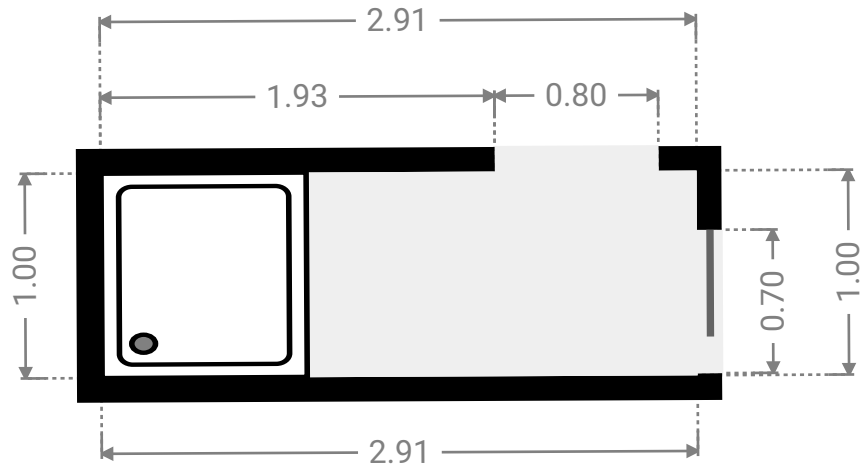
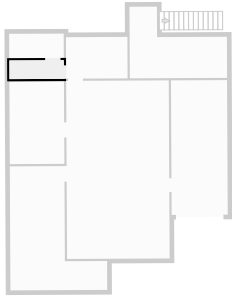

▼ **Toilet**
Ground Floor

WIDTH: 2.92 m • LENGTH: 1.31 m
AREA: 3.80 m² • PERIMETER: 8.44 m

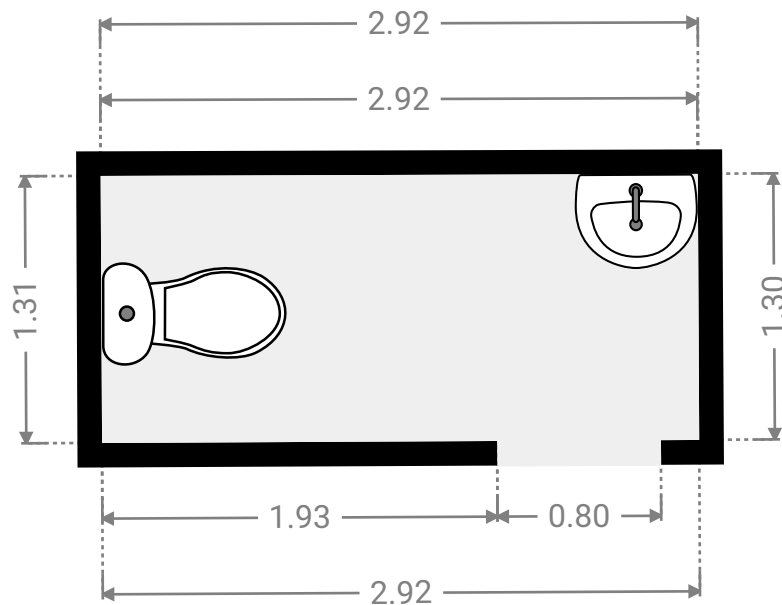
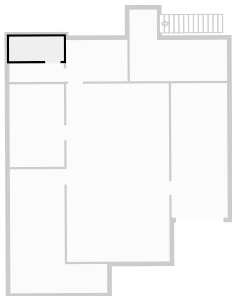

▼ **Other**
Ground Floor

WIDTH: 5.21 m • LENGTH: 3.83 m
AREA: 13.85 m² • PERIMETER: 18.07 m

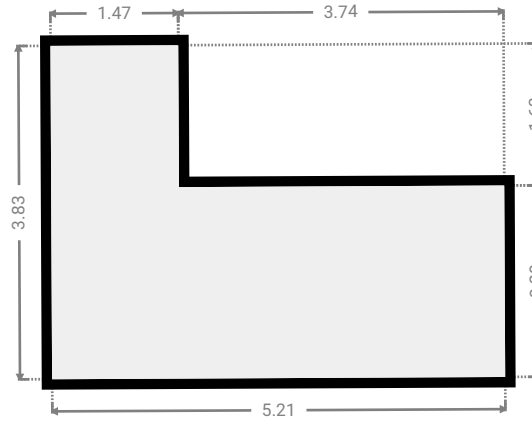
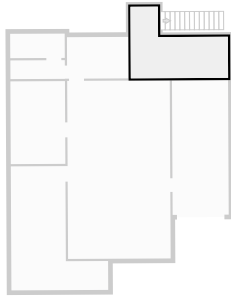

▼ **Garage**
Ground Floor

WIDTH: 3.00 m • LENGTH: 7.20 m
AREA: 21.60 m² • PERIMETER: 20.40 m

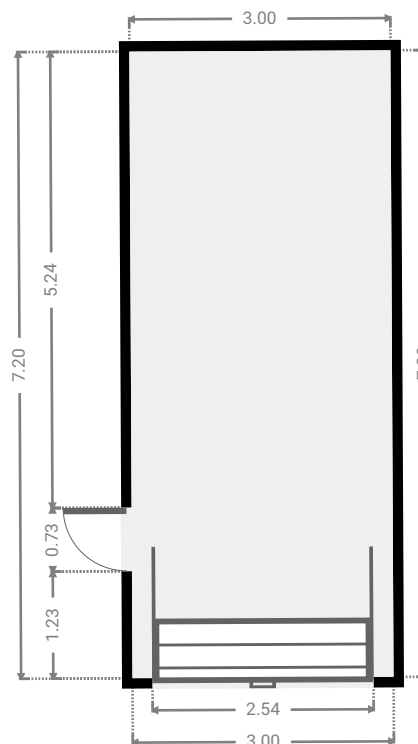
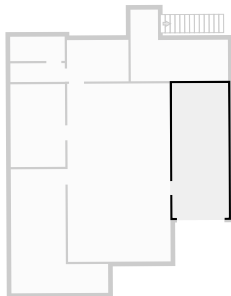

▼ 1st Floor

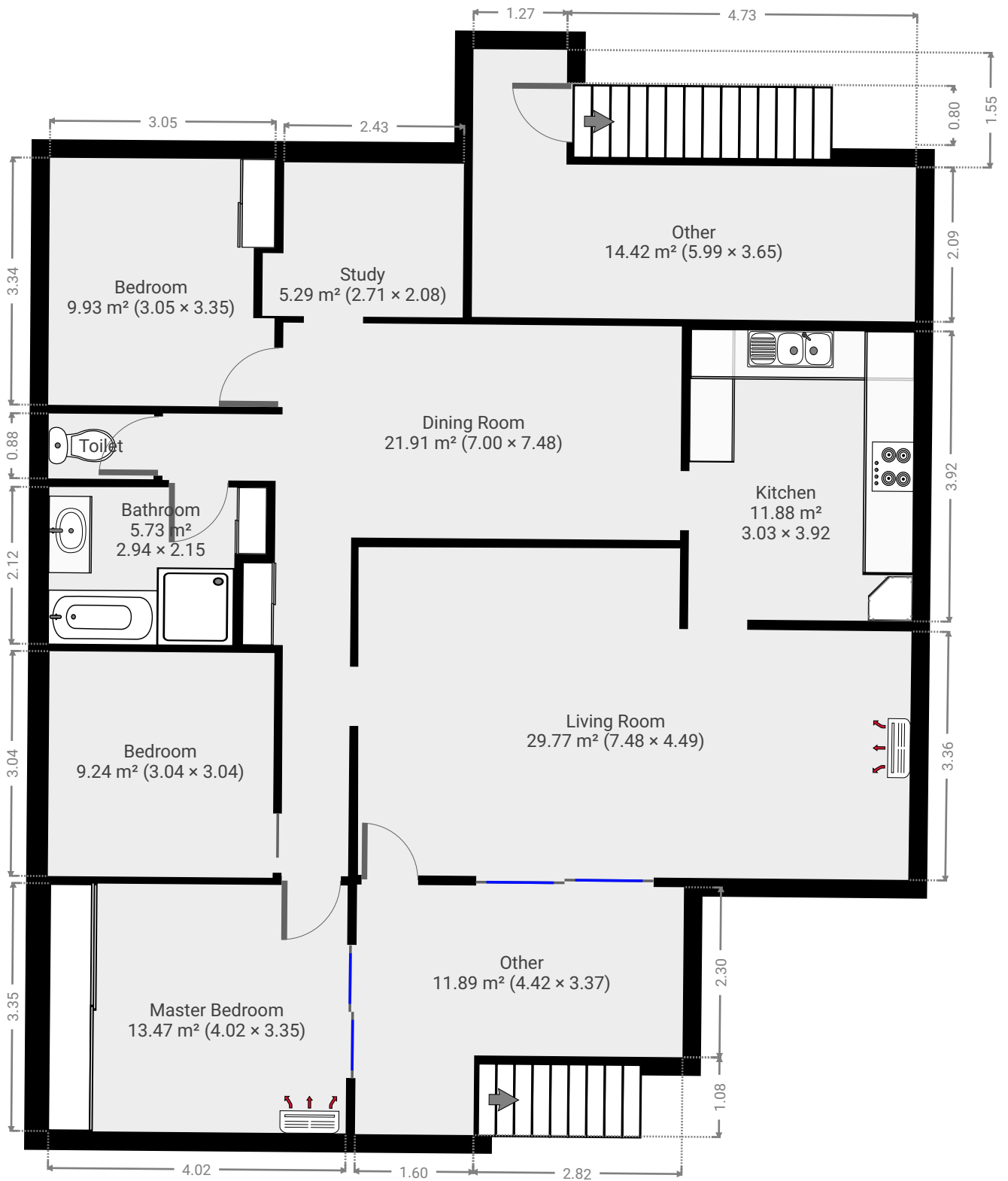

▼ **Living Room**
1st Floor

WIDTH: 7.48 m • LENGTH: 4.49 m
AREA: 29.77 m² • PERIMETER: 23.81 m

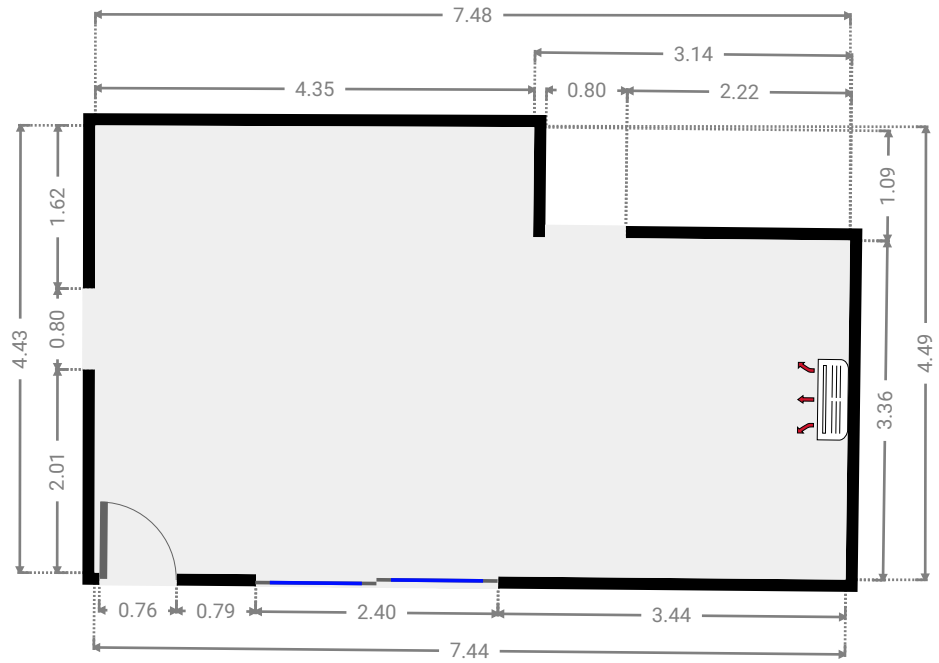
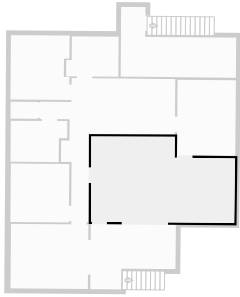

▼ **Kitchen**
1st Floor

WIDTH: 3.03 m • LENGTH: 3.92 m
AREA: 11.88 m² • PERIMETER: 13.90 m

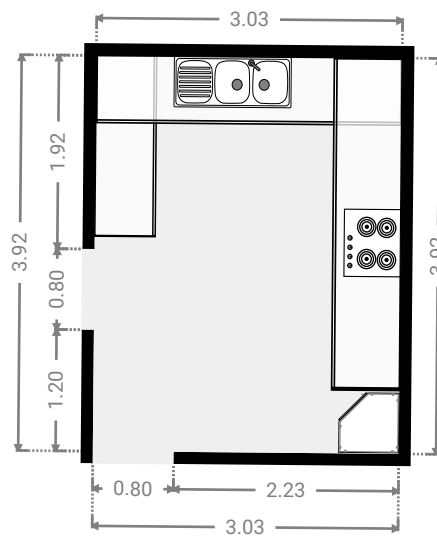
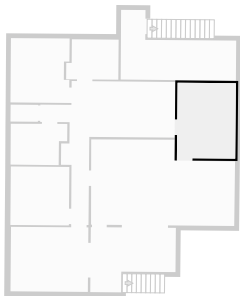

▼ Dining Room
1st Floor

WIDTH: 7.00 m • LENGTH: 7.48 m
AREA: 21.91 m² • PERIMETER: 29.80 m

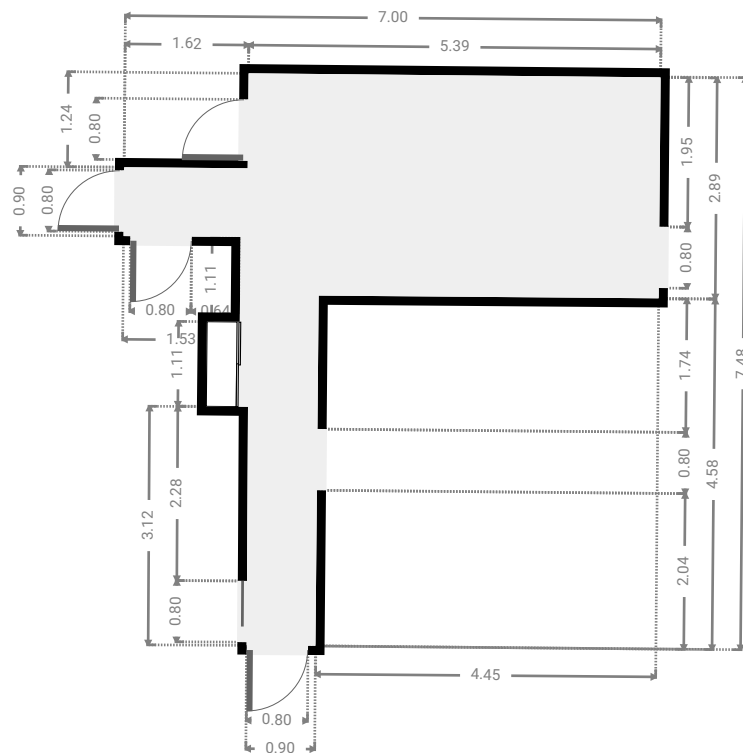
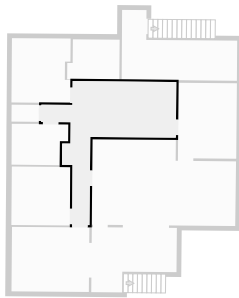

▼ Study
1st Floor

WIDTH: 2.71 m • LENGTH: 2.08 m
AREA: 5.29 m² • PERIMETER: 9.58 m

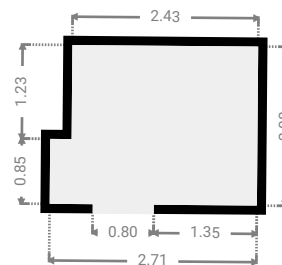
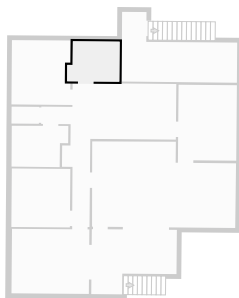

▼ **Bedroom**
1st Floor

WIDTH: 3.04 m • LENGTH: 3.04 m
AREA: 9.24 m² • PERIMETER: 12.16 m

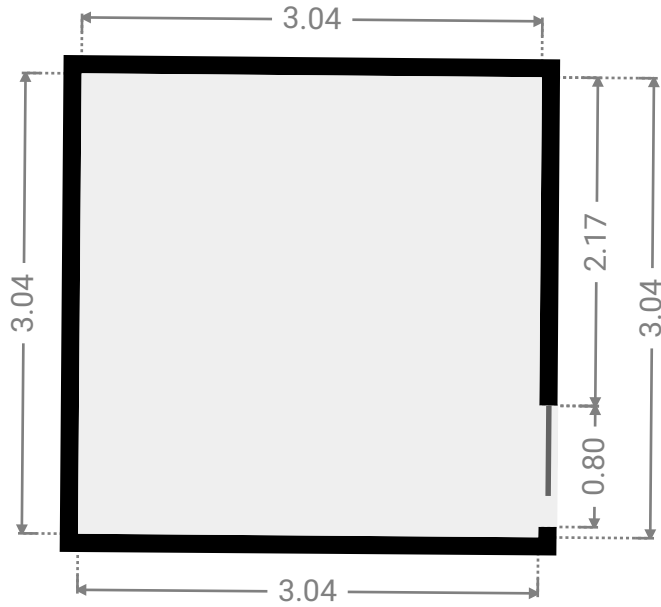
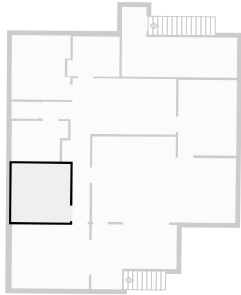

▼ **Bedroom**
1st Floor

WIDTH: 3.05 m • LENGTH: 3.35 m
AREA: 9.93 m² • PERIMETER: 13.36 m

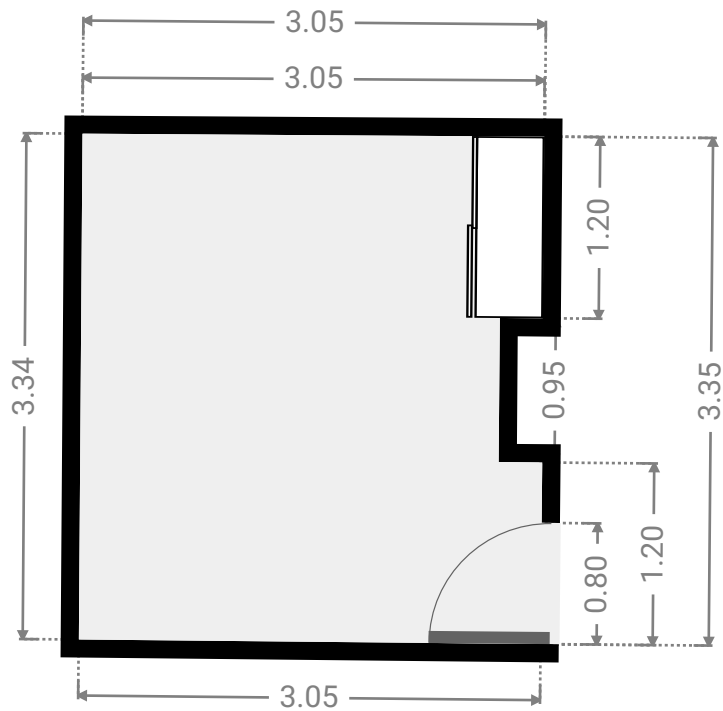
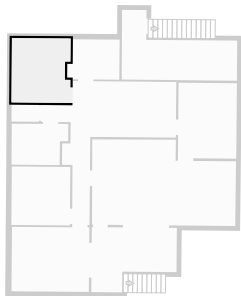

▼ **Toilet**
1st Floor

WIDTH: 1.42 m • LENGTH: 0.88 m
AREA: 1.25 m² • PERIMETER: 4.60 m

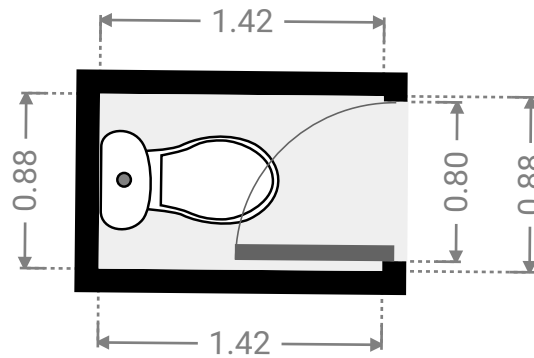
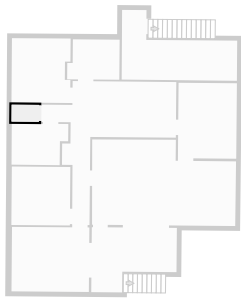

▼ **Bathroom**
1st Floor

WIDTH: 2.94 m • LENGTH: 2.15 m
AREA: 5.73 m² • PERIMETER: 10.14 m

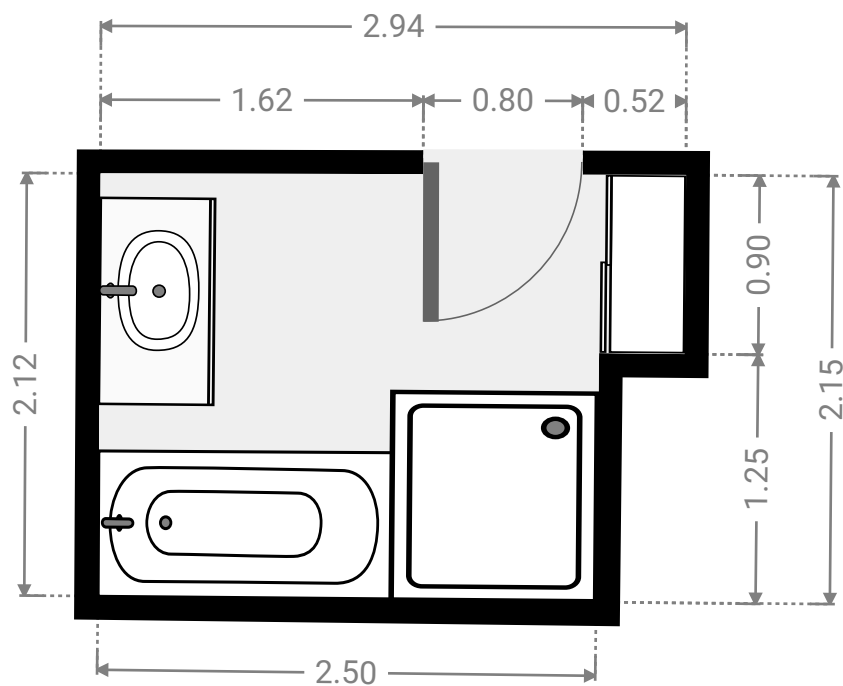
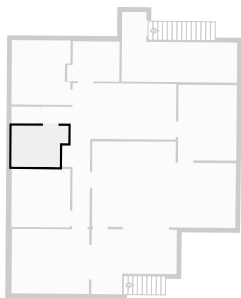

▼ **Master Bedroom**
1st Floor

WIDTH: 4.02 m • LENGTH: 3.35 m
AREA: 13.47 m² • PERIMETER: 14.74 m

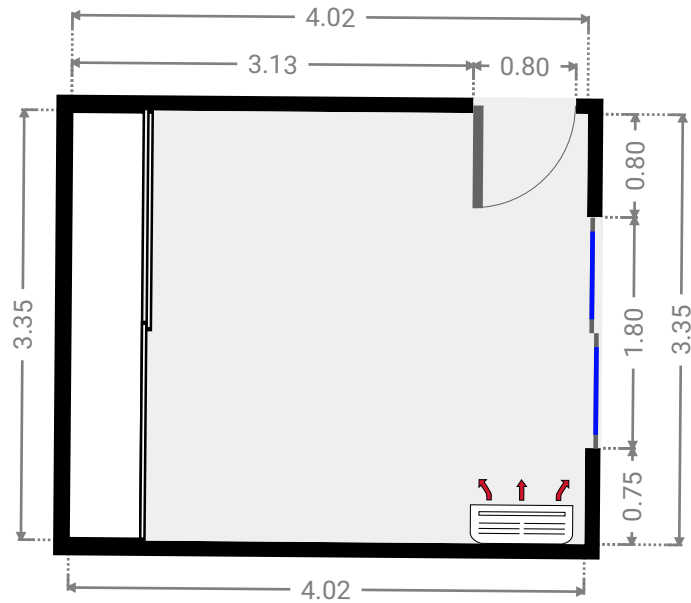
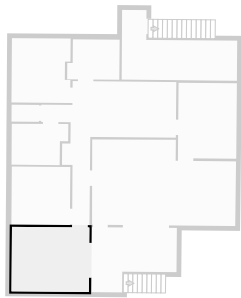

▼ **Other**
1st Floor

WIDTH: 4.42 m • LENGTH: 3.37 m
AREA: 11.89 m² • PERIMETER: 15.59 m

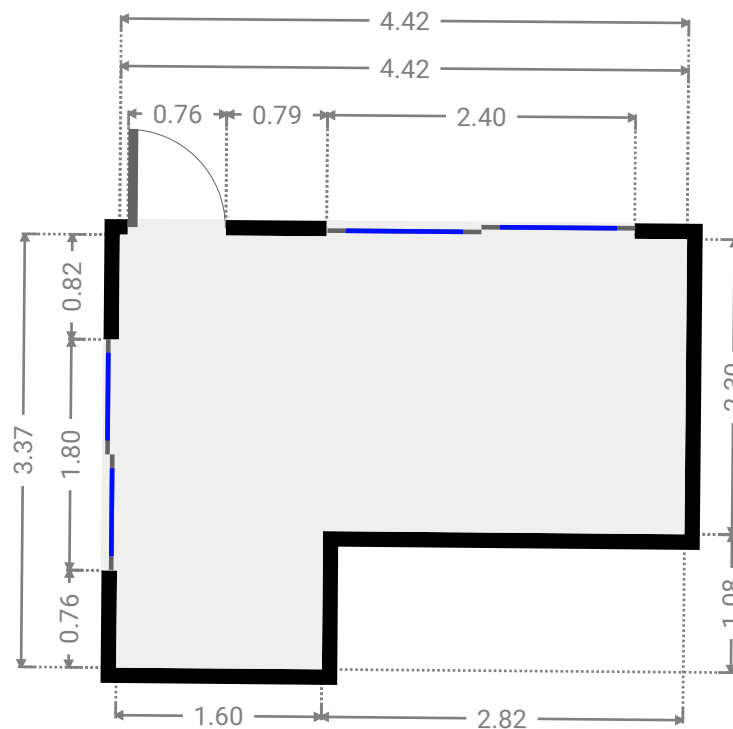
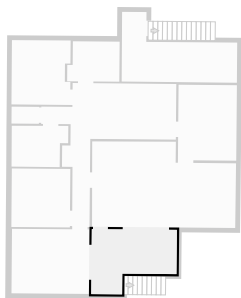

▼ Other
1st Floor

WIDTH: 5.99 m • LENGTH: 3.65 m
AREA: 14.42 m² • PERIMETER: 19.24 m

