

# 353 Philp Avenue

## Ground Floor

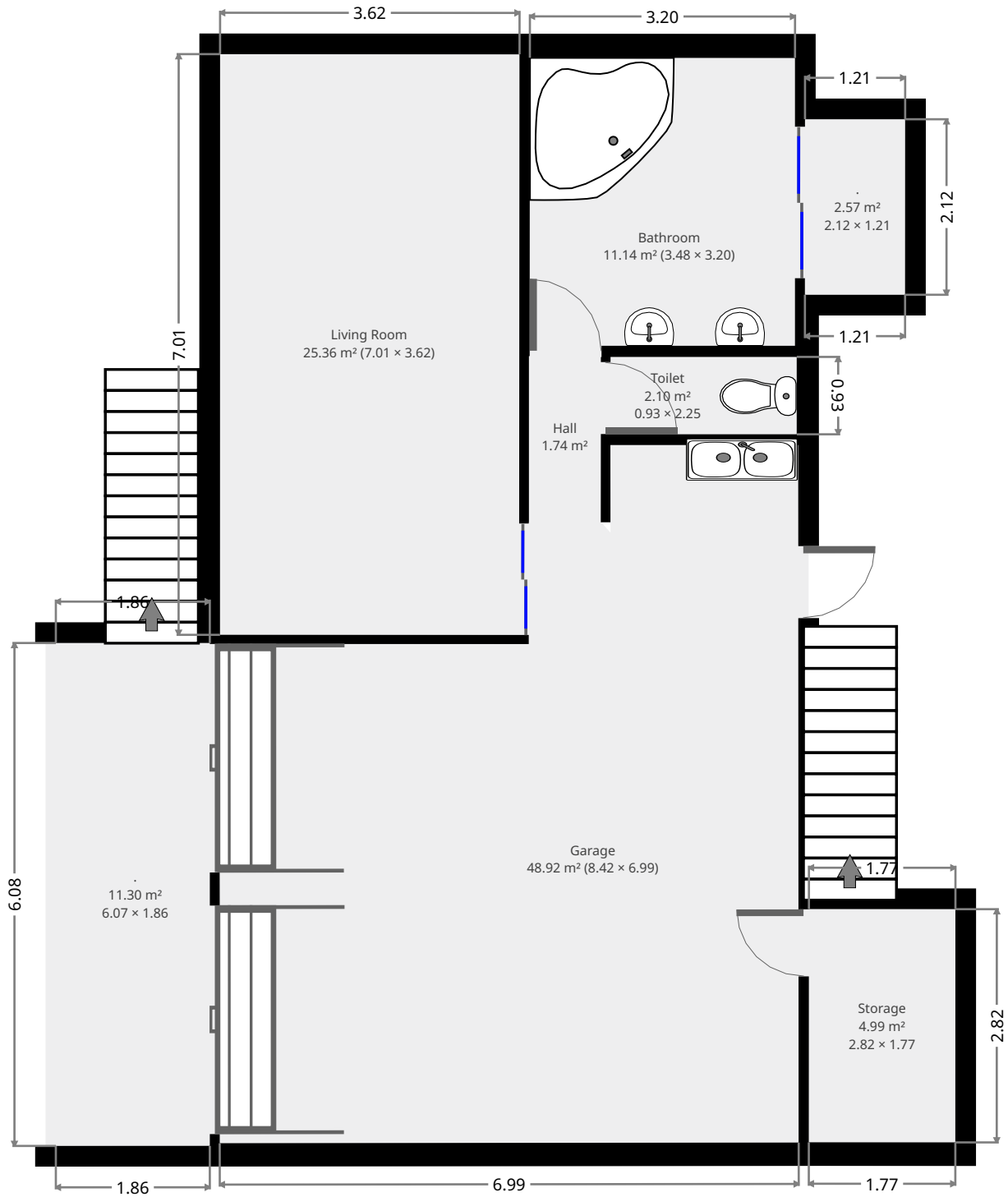

THIS FLOORPLAN IS PROVIDED WITHOUT WARRANTY OF ANY KIND. SENSOPIA DISCLAIMS ANY WARRANTY INCLUDING, WITHOUT LIMITATION, SATISFACTORY QUALITY OR ACCURACY OF DIMENSIONS.



# 353 Philp Avenue

## Garage

Width: 6.99 m  
Length: 8.42 m  
Area: 48.92 m<sup>2</sup>  
Perimeter: 30.84 m

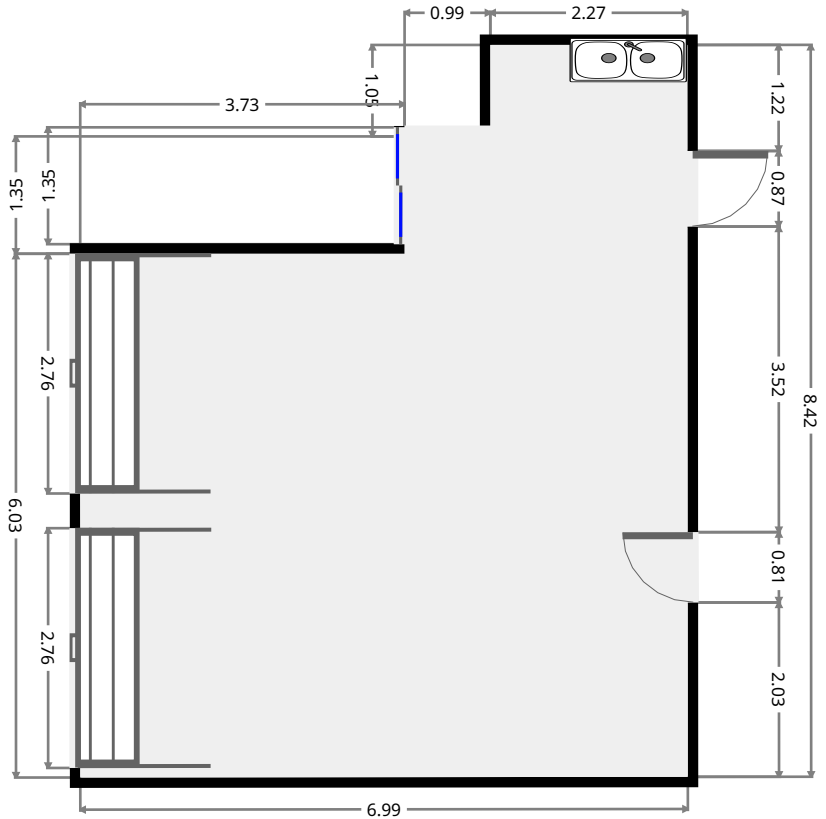
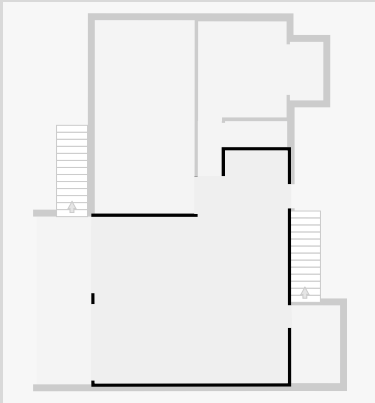

## Storage

Width: 1.77 m  
Length: 2.82 m  
Area: 4.99 m<sup>2</sup>  
Perimeter: 9.17 m

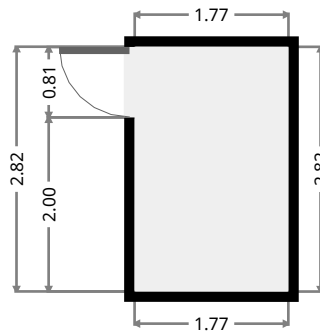
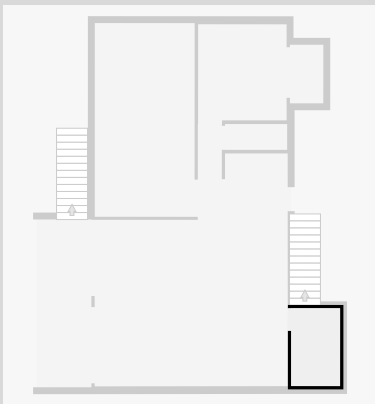

# 353 Philp Avenue

## Living Room

Width: 3.62 m  
Length: 7.01 m  
Area: 25.36 m<sup>2</sup>  
Perimeter: 21.26 m

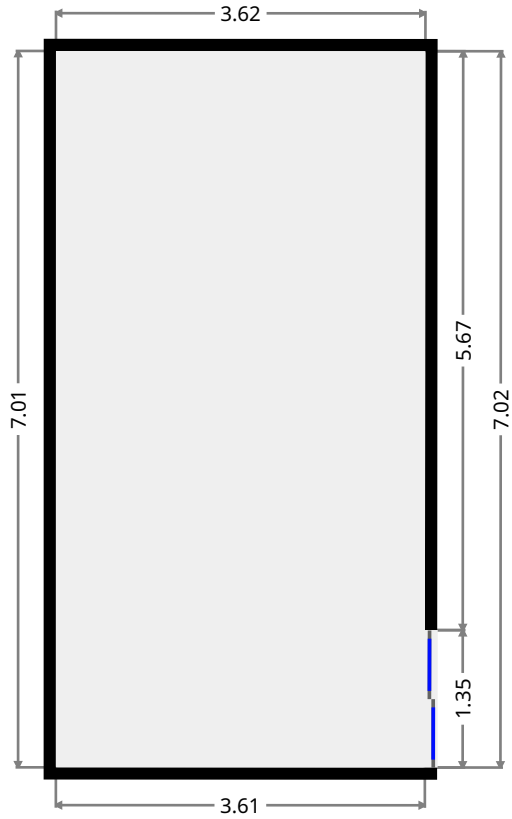
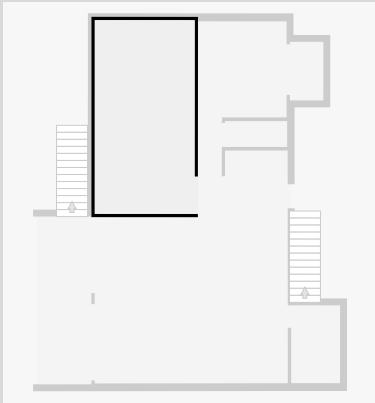

## Hall

Width: 0.87 m  
Length: 2.00 m  
Area: 1.74 m<sup>2</sup>  
Perimeter: 5.74 m

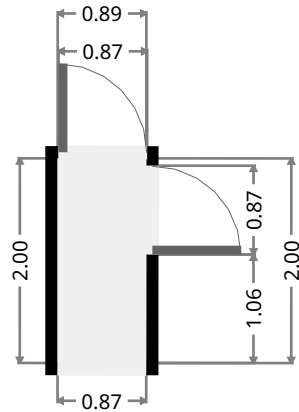
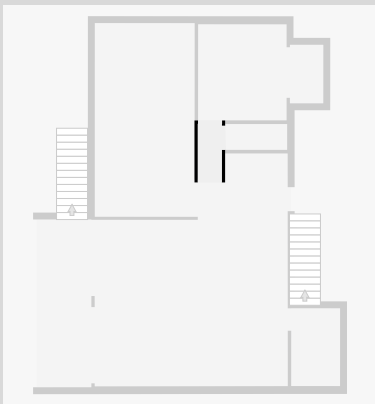

# 353 Philp Avenue

## Toilet

Width: 0.93 m  
Length: 2.25 m  
Area: 2.10 m<sup>2</sup>  
Perimeter: 6.37 m

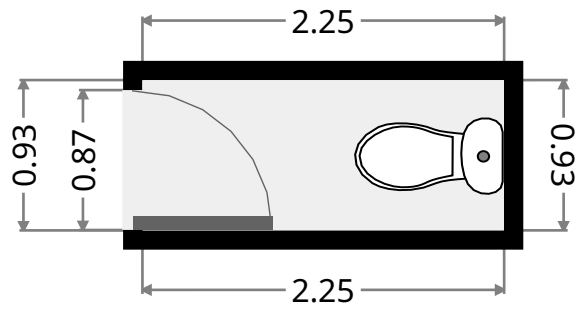
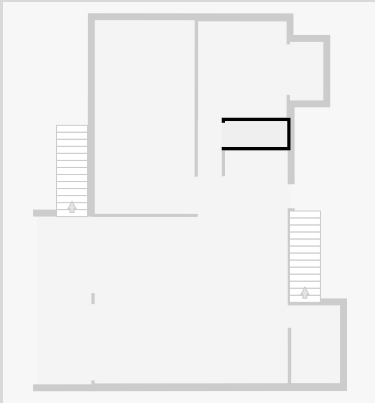

## Bathroom

Width: 3.20 m  
Length: 3.48 m  
Area: 11.14 m<sup>2</sup>  
Perimeter: 13.36 m

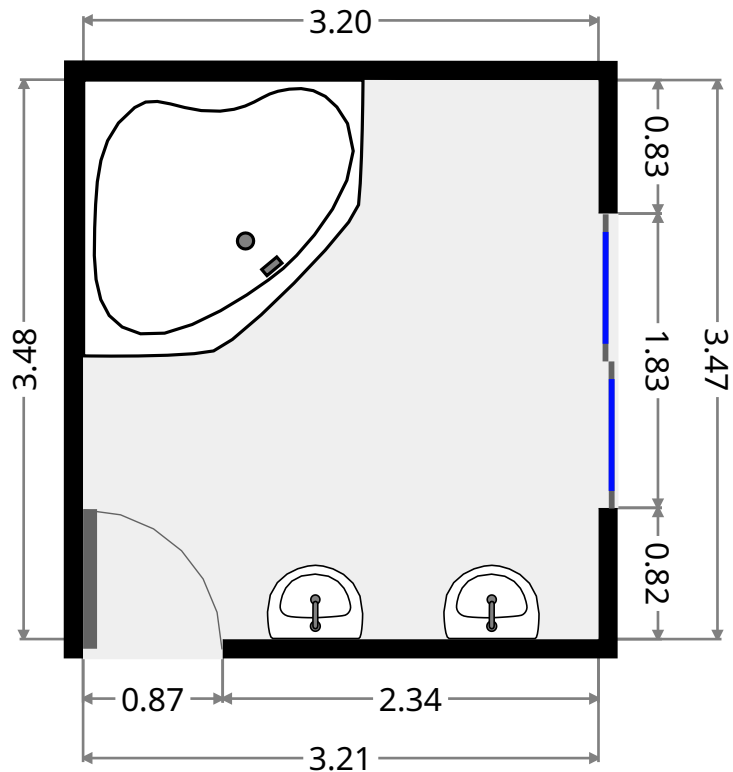
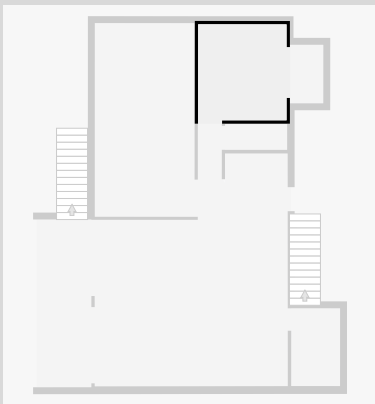

THIS FLOORPLAN IS PROVIDED WITHOUT WARRANTY OF ANY KIND. SENSOPIA DISCLAIMS ANY WARRANTY INCLUDING, WITHOUT LIMITATION, SATISFACTORY QUALITY OR ACCURACY OF DIMENSIONS.

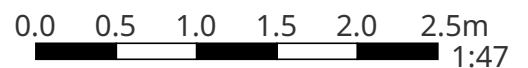

# 353 Philp Avenue

- Width: 1.21 m
- Length: 2.12 m
- Area: 2.57 m<sup>2</sup>
- Perimeter: 6.66 m

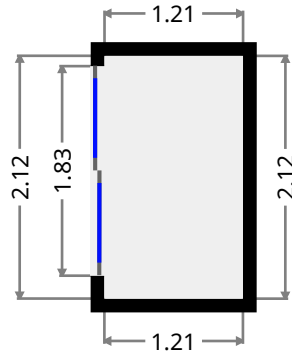
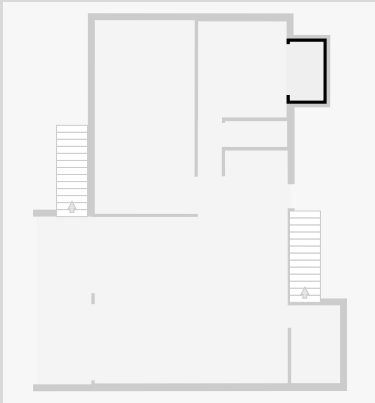

- Width: 1.86 m
- Length: 6.07 m
- Area: 11.30 m<sup>2</sup>
- Perimeter: 15.87 m

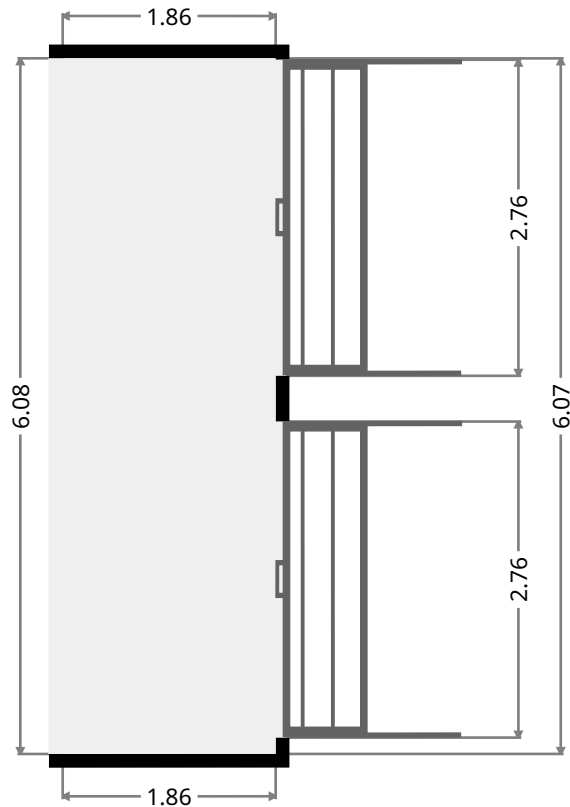
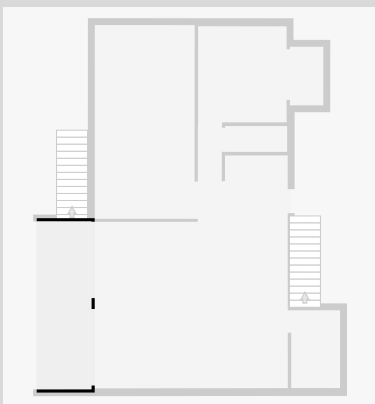

THIS FLOORPLAN IS PROVIDED WITHOUT WARRANTY OF ANY KIND. SENSOPIA DISCLAIMS ANY WARRANTY INCLUDING, WITHOUT LIMITATION, SATISFACTORY QUALITY OR ACCURACY OF DIMENSIONS.

# 353 Philp Avenue

## 1st Floor

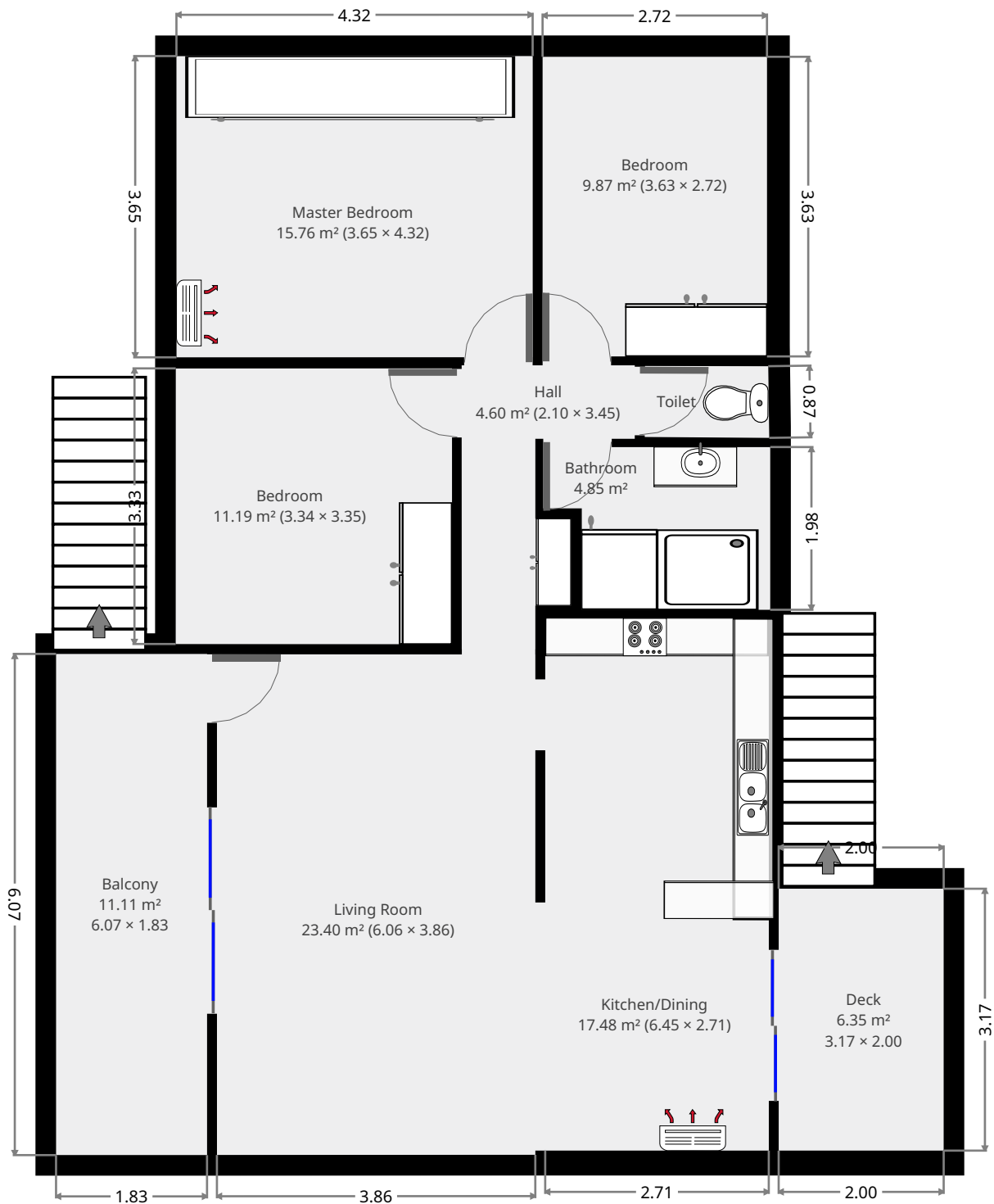

THIS FLOORPLAN IS PROVIDED WITHOUT WARRANTY OF ANY KIND. SENSOPIA DISCLAIMS ANY WARRANTY INCLUDING, WITHOUT LIMITATION, SATISFACTORY QUALITY OR ACCURACY OF DIMENSIONS.

# 353 Philp Avenue

## Living Room

Width: 3.86 m  
 Length: 6.06 m  
 Area: 23.40 m<sup>2</sup>  
 Perimeter: 19.85 m

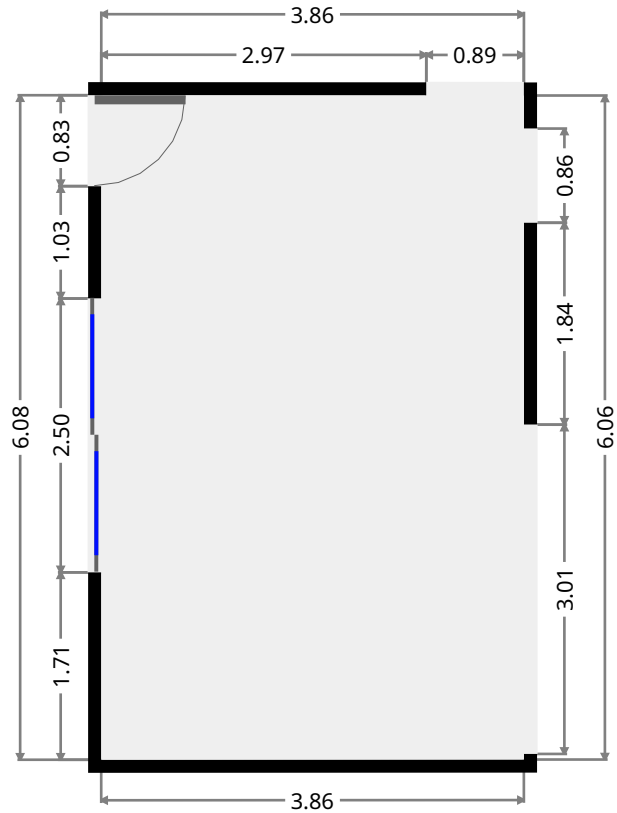
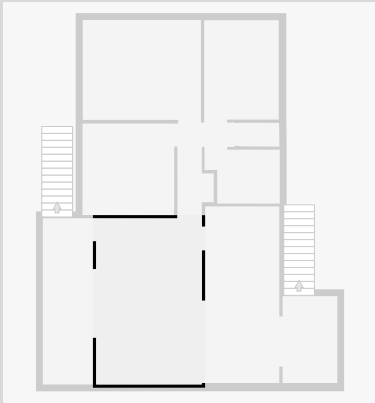

## Kitchen/Dining

Width: 2.71 m  
 Length: 6.45 m  
 Area: 17.48 m<sup>2</sup>  
 Perimeter: 18.32 m

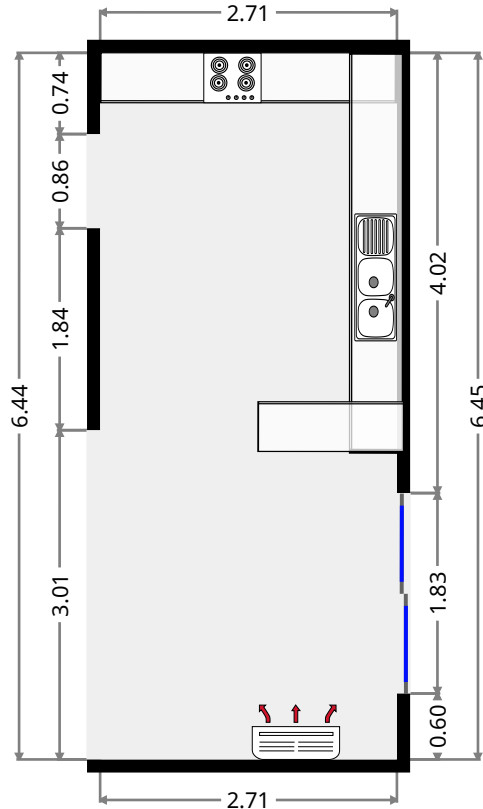
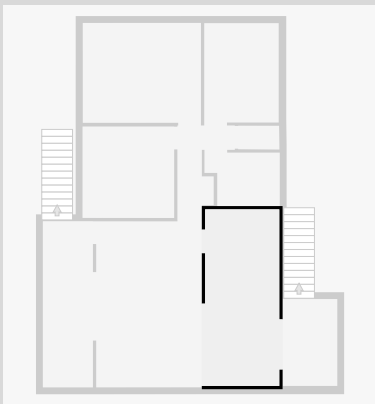

THIS FLOORPLAN IS PROVIDED WITHOUT WARRANTY OF ANY KIND. SENSOPIA DISCLAIMS ANY WARRANTY INCLUDING, WITHOUT LIMITATION, SATISFACTORY QUALITY OR ACCURACY OF DIMENSIONS.

# 353 Philp Avenue

## Hall

Width: 2.10 m  
 Length: 3.45 m  
 Area: 4.60 m<sup>2</sup>  
 Perimeter: 11.94 m

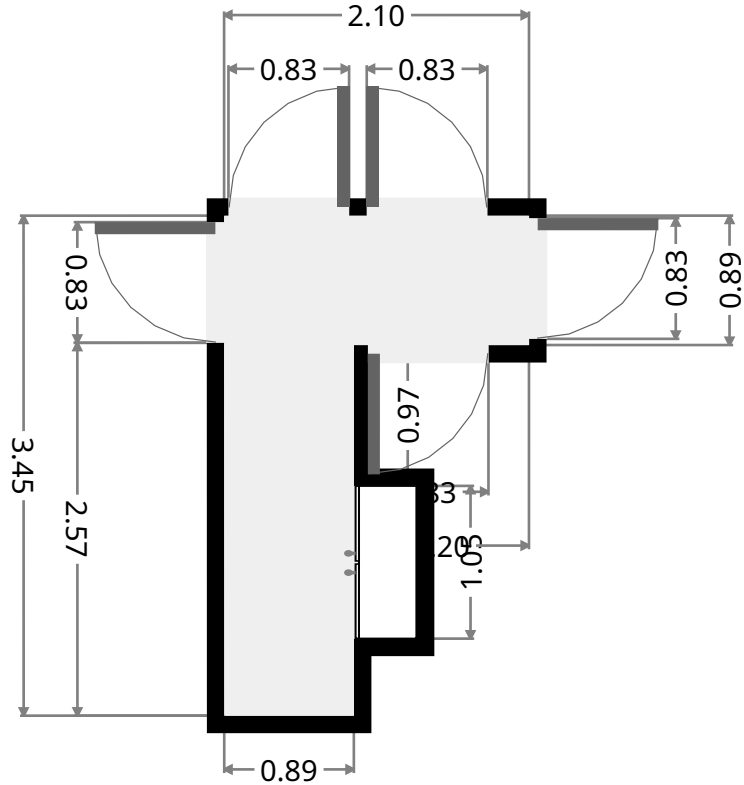
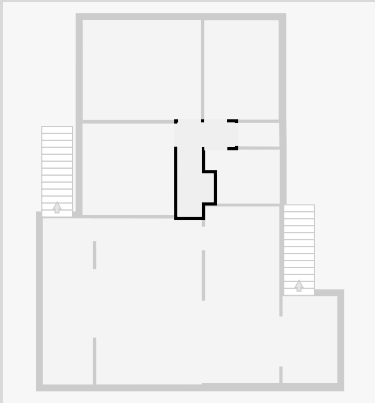

## Bedroom

Width: 3.34 m  
 Length: 3.35 m  
 Area: 11.19 m<sup>2</sup>  
 Perimeter: 13.38 m

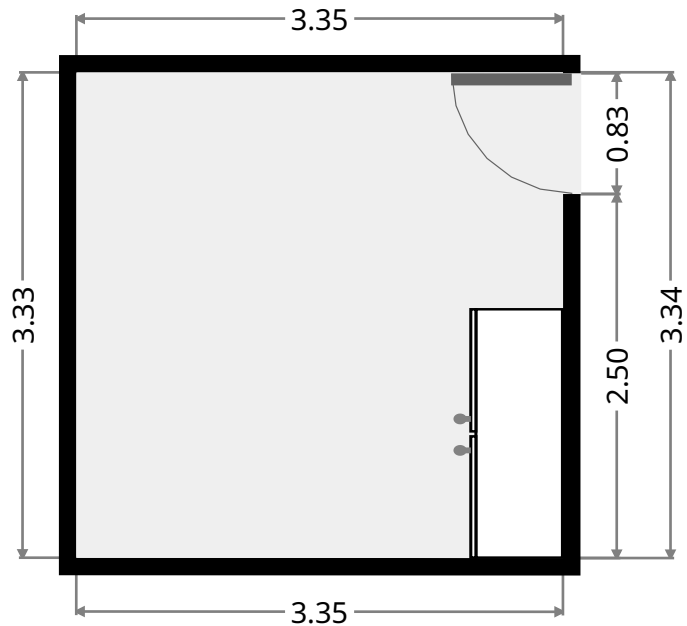
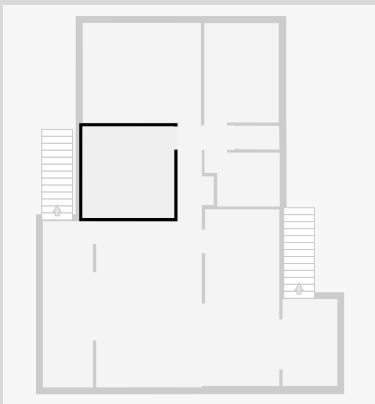

THIS FLOORPLAN IS PROVIDED WITHOUT WARRANTY OF ANY KIND. SENSOPIA DISCLAIMS ANY WARRANTY INCLUDING, WITHOUT LIMITATION, SATISFACTORY QUALITY OR ACCURACY OF DIMENSIONS.

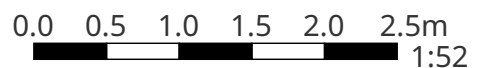



# 353 Philp Avenue

## Master Bedroom

Width: 3.65 m  
Length: 4.32 m  
Area: 15.76 m<sup>2</sup>  
Perimeter: 15.93 m

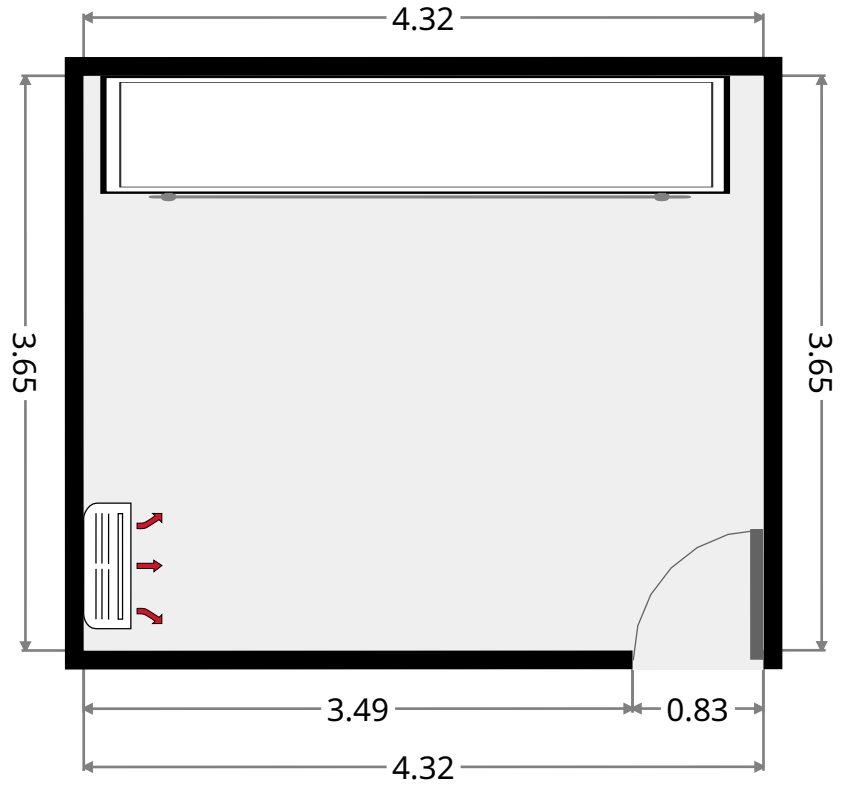
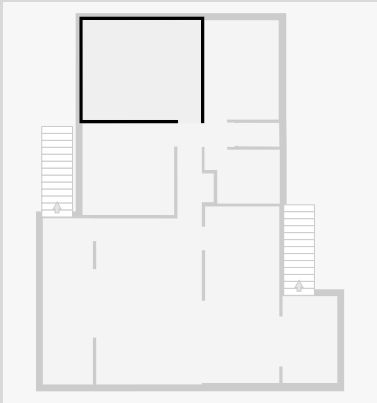

## Bedroom

Width: 2.72 m  
Length: 3.63 m  
Area: 9.87 m<sup>2</sup>  
Perimeter: 12.70 m

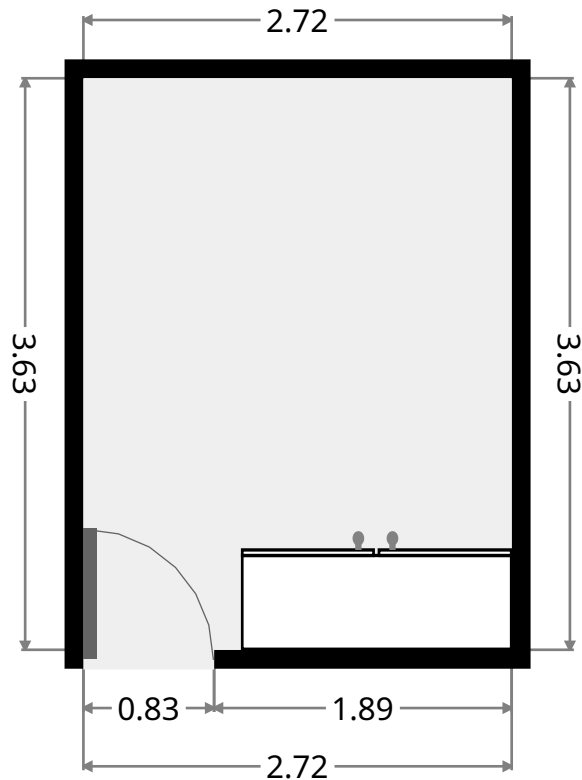
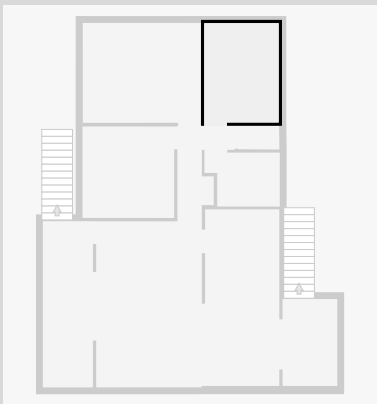

THIS FLOORPLAN IS PROVIDED WITHOUT WARRANTY OF ANY KIND. SENSOPIA DISCLAIMS ANY WARRANTY INCLUDING, WITHOUT LIMITATION, SATISFACTORY QUALITY OR ACCURACY OF DIMENSIONS.

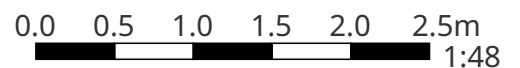

# 353 Philp Avenue

## Bathroom

Width: 1.98 m  
 Length: 2.76 m  
 Area: 4.85 m<sup>2</sup>  
 Perimeter: 9.44 m

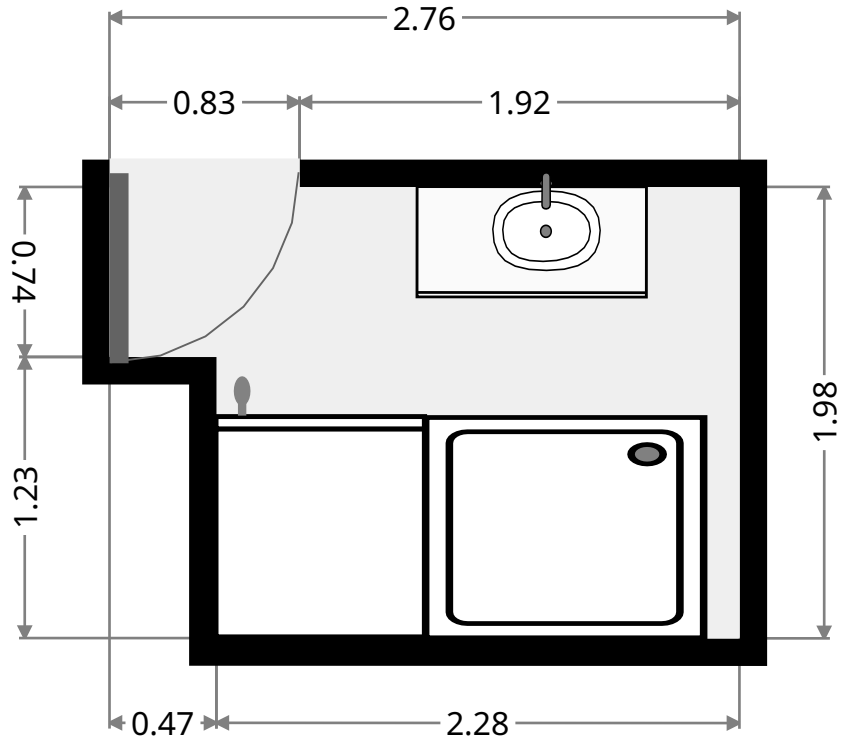
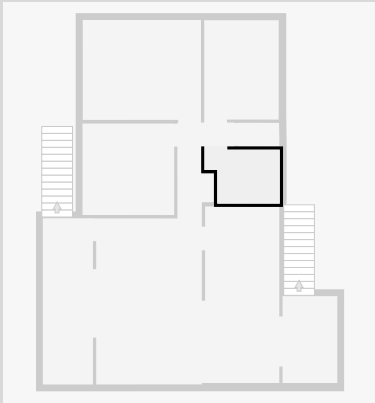

## Toilet

Width: 0.86 m  
 Length: 1.51 m  
 Area: 1.30 m<sup>2</sup>  
 Perimeter: 4.73 m

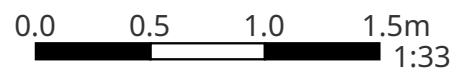
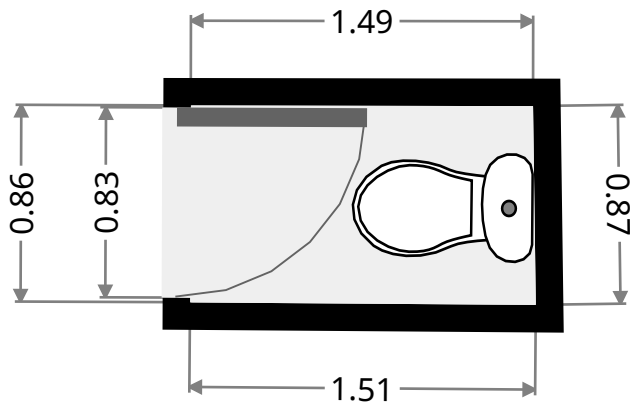
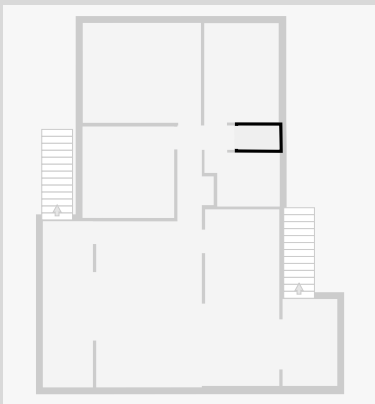

# 353 Philp Avenue

## Deck

Width: 2.00 m  
Length: 3.17 m  
Area: 6.35 m<sup>2</sup>  
Perimeter: 10.35 m

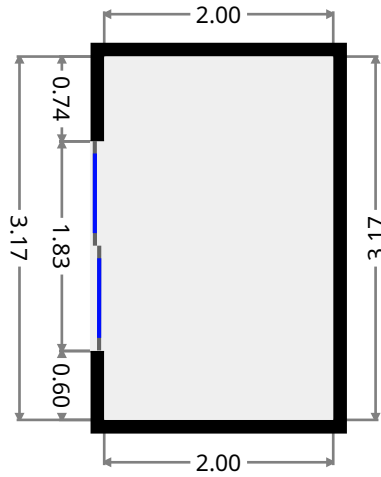
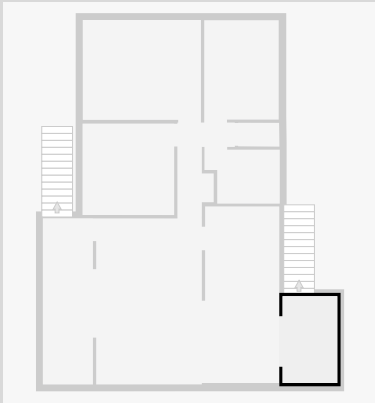

## Balcony

Width: 1.83 m  
Length: 6.07 m  
Area: 11.11 m<sup>2</sup>  
Perimeter: 15.80 m

