

Ground Floor

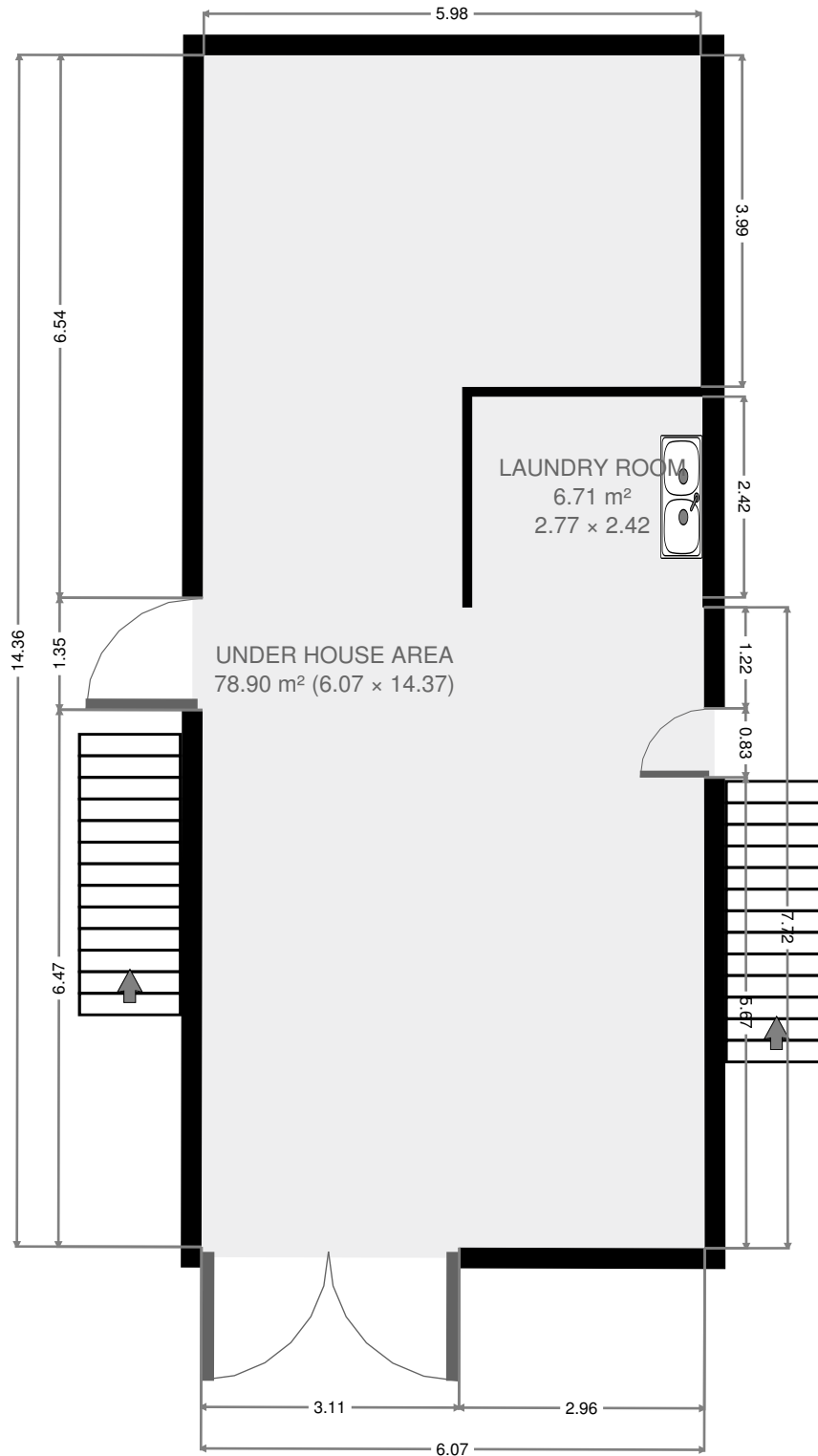

THIS FLOORPLAN IS PROVIDED WITHOUT WARRANTY OF ANY KIND. SENSOPIA DISCLAIMS ANY WARRANTY INCLUDING, WITHOUT LIMITATION, SATISFACTORY QUALITY OR ACCURACY OF DIMENSIONS.

351 Thozet Road

Under House Area

Width: 6.07 m
 Length: 14.37 m
 Area: 78.90 m²
 Perimeter: 46.57 m
 Ceiling Height: 2.17 m

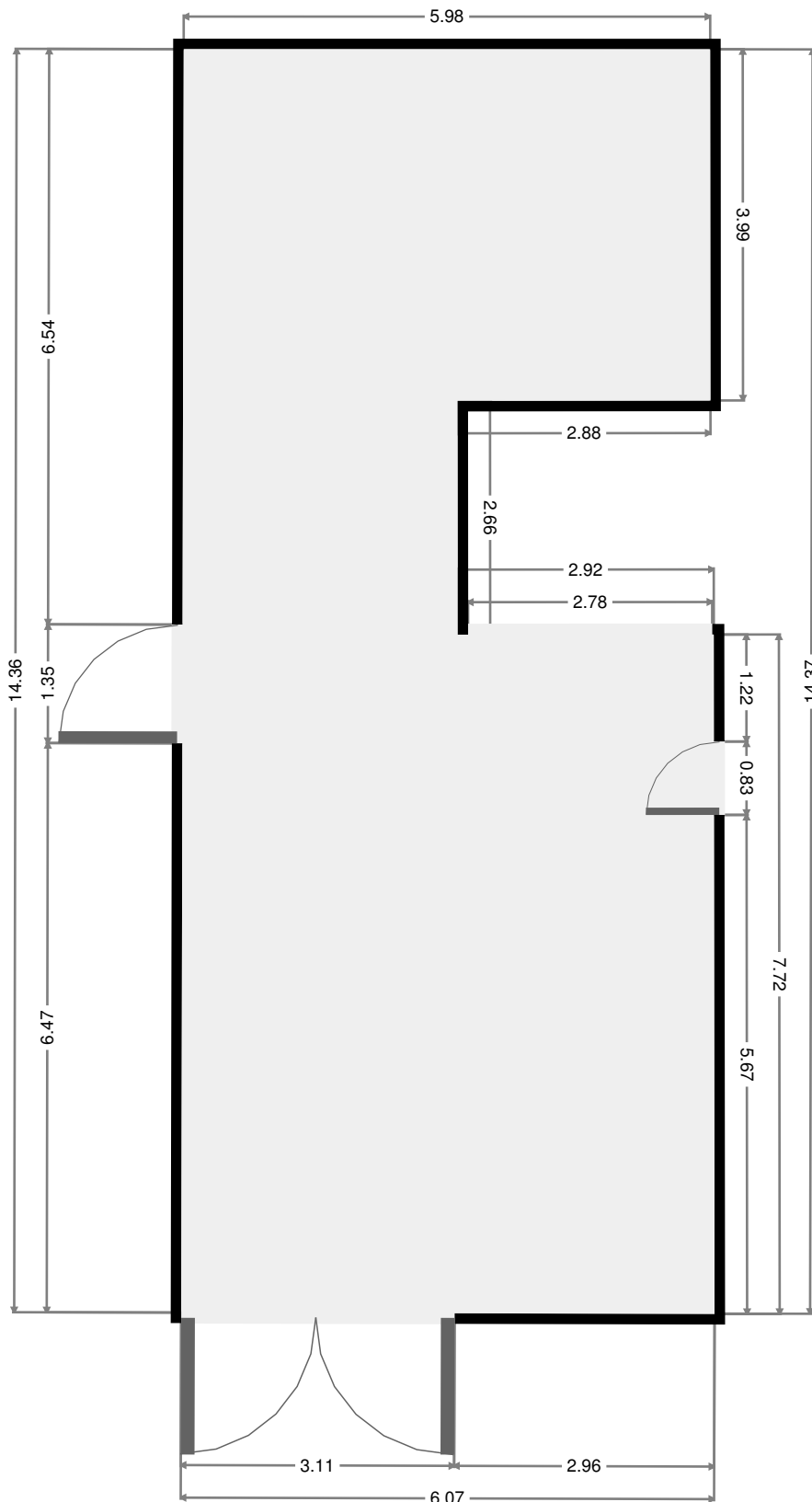
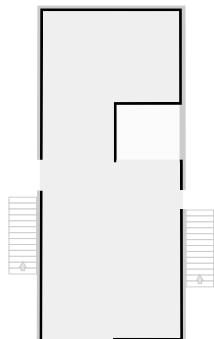

THIS FLOORPLAN IS PROVIDED WITHOUT WARRANTY OF ANY KIND. SENSOPIA DISCLAIMS ANY WARRANTY INCLUDING, WITHOUT LIMITATION, SATISFACTORY QUALITY OR ACCURACY OF DIMENSIONS.

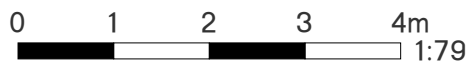

351 Thozet Road

2016-12-06

Laundry Room

Width: 2.42 m
Length: 2.77 m
Area: 6.71 m²
Perimeter: 10.39 m

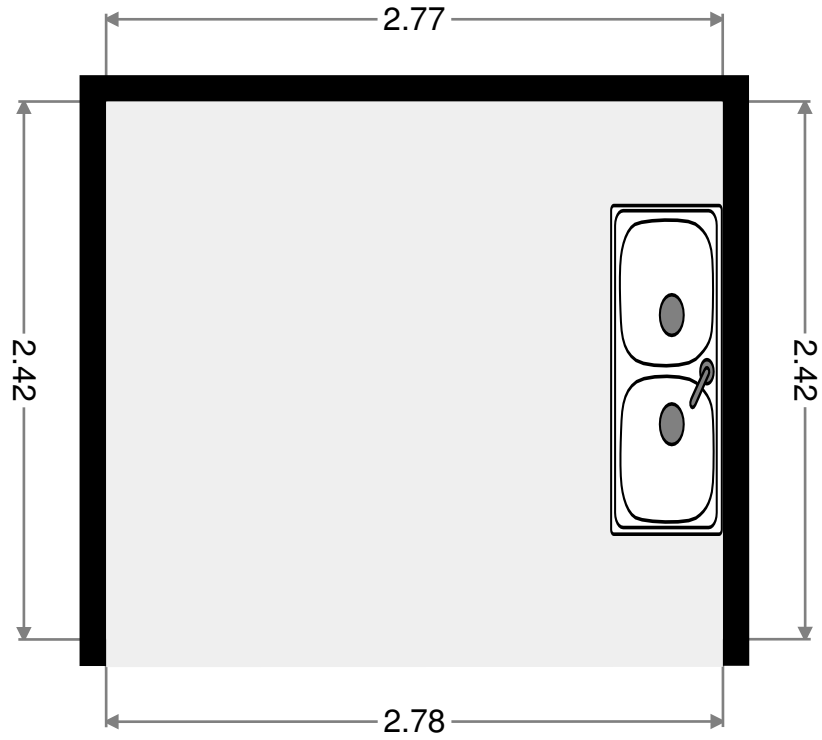
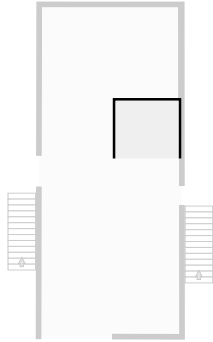

THIS FLOORPLAN IS PROVIDED WITHOUT WARRANTY OF ANY KIND. SENSOPIA DISCLAIMS ANY WARRANTY INCLUDING, WITHOUT LIMITATION, SATISFACTORY QUALITY OR ACCURACY OF DIMENSIONS.

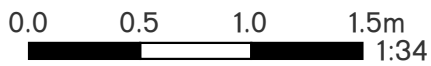

351 Thozet Road

2016-12-06

1st Floor

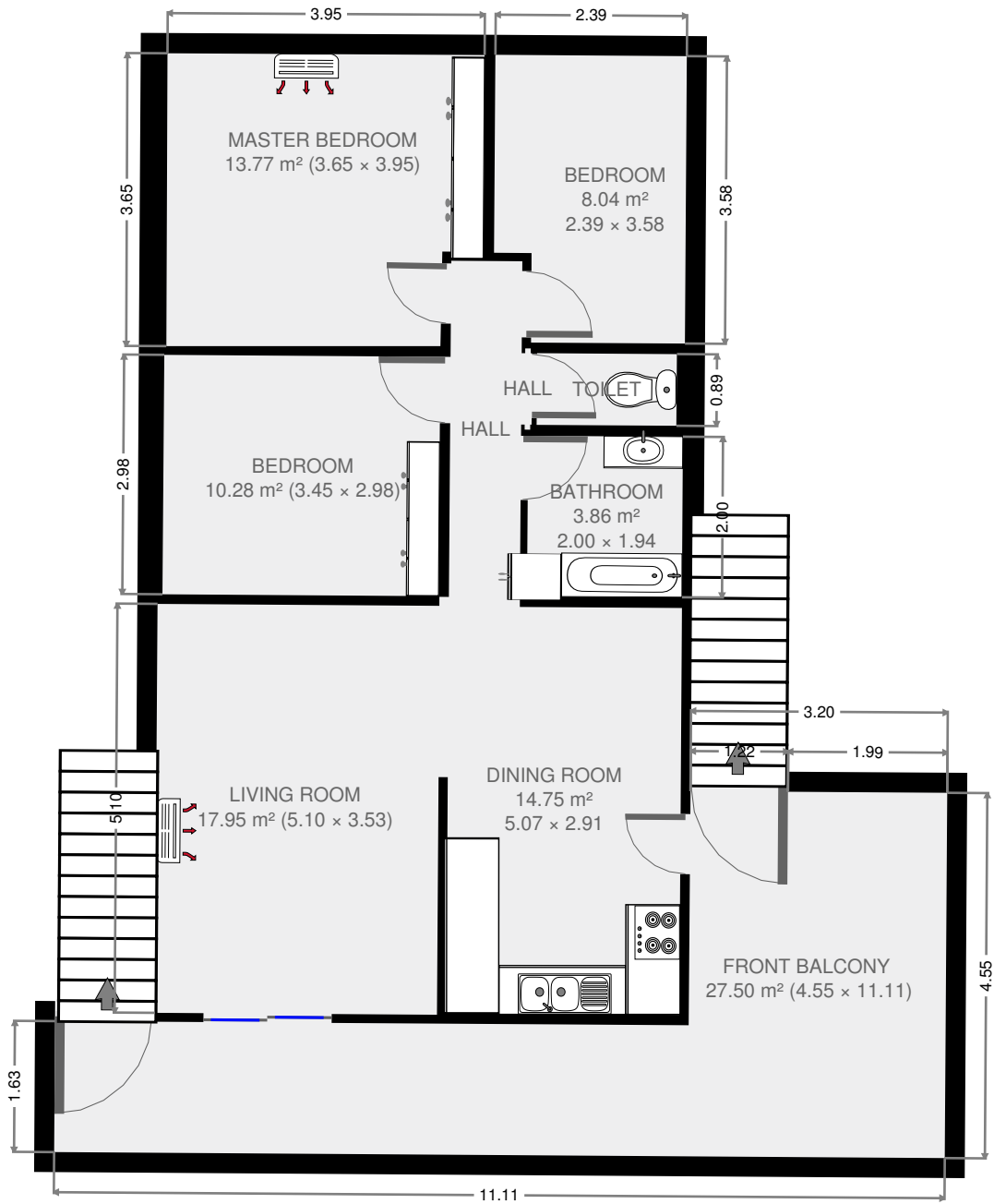

THIS FLOORPLAN IS PROVIDED WITHOUT WARRANTY OF ANY KIND. SENSOPIA DISCLAIMS ANY WARRANTY INCLUDING, WITHOUT LIMITATION, SATISFACTORY QUALITY OR ACCURACY OF DIMENSIONS.

351 Thozet Road

Dining Room

Width: 2.91 m
 Length: 5.07 m
 Area: 14.75 m²
 Perimeter: 15.96 m

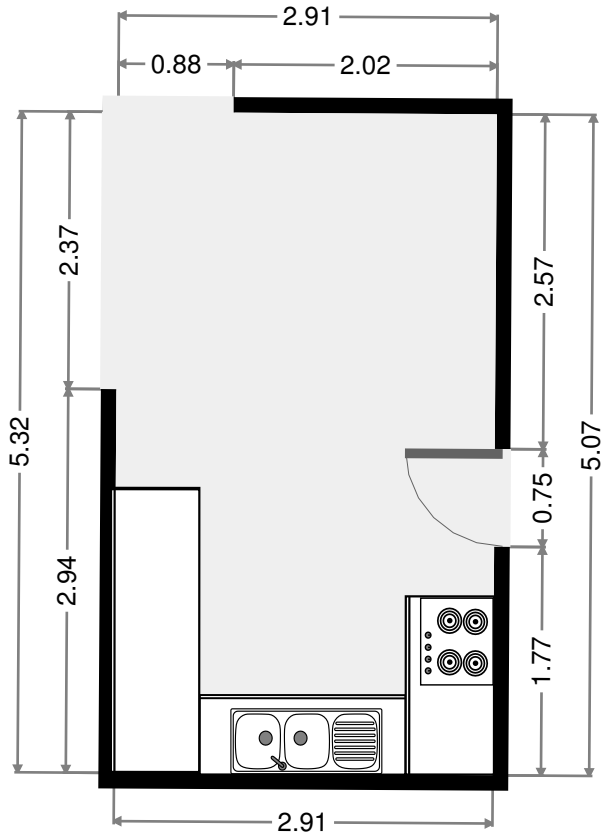
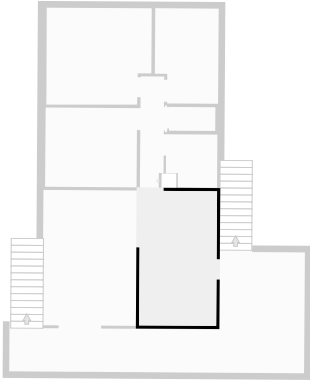

Living Room

Width: 3.53 m
 Length: 5.10 m
 Area: 17.95 m²
 Perimeter: 17.24 m

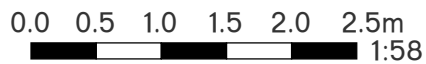
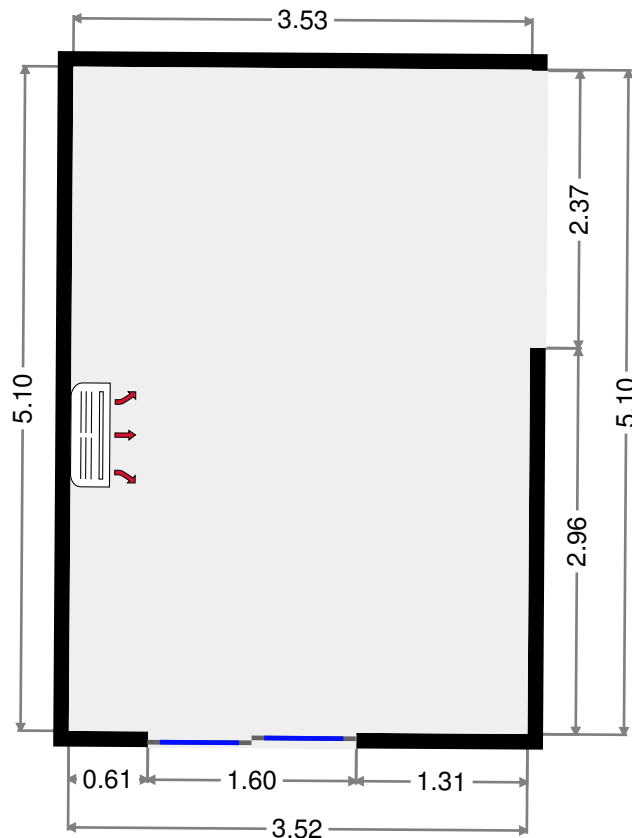
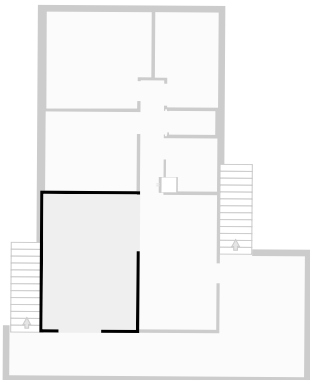

THIS FLOORPLAN IS PROVIDED WITHOUT WARRANTY OF ANY KIND. SENSOPIA DISCLAIMS ANY WARRANTY INCLUDING, WITHOUT LIMITATION, SATISFACTORY QUALITY OR ACCURACY OF DIMENSIONS.

Hall

Width: 0.89 m
 Length: 4.21 m
 Area: 3.72 m²
 Perimeter: 10.16 m

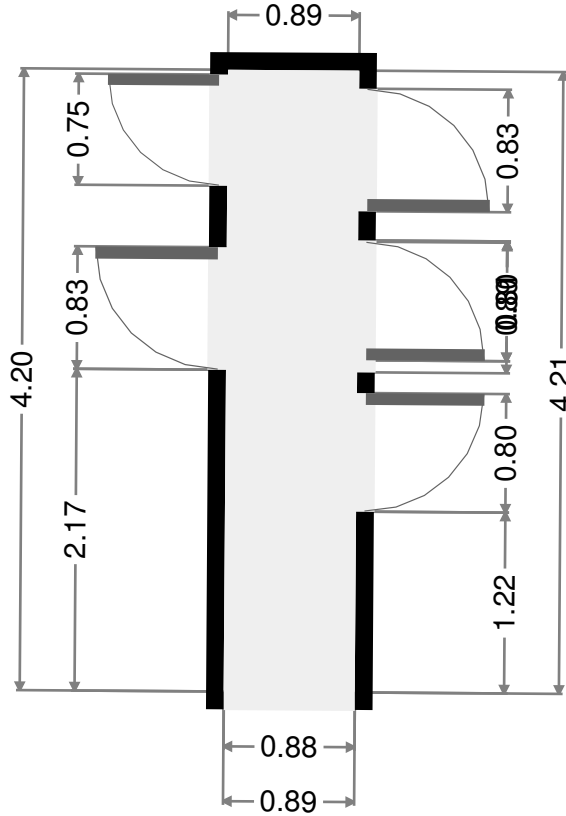
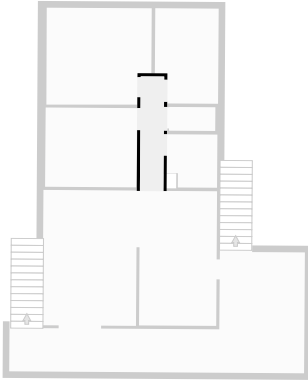

Bathroom

Width: 1.94 m
 Length: 2.00 m
 Area: 3.86 m²
 Perimeter: 7.87 m

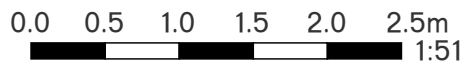
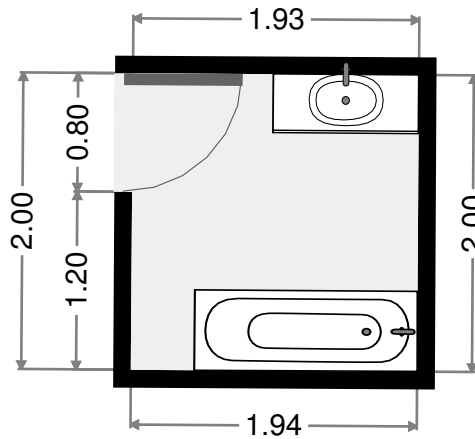
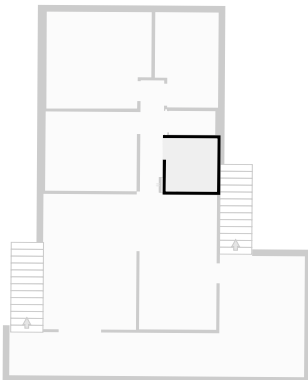

THIS FLOORPLAN IS PROVIDED WITHOUT WARRANTY OF ANY KIND. SENSOPIA DISCLAIMS ANY WARRANTY INCLUDING, WITHOUT LIMITATION, SATISFACTORY QUALITY OR ACCURACY OF DIMENSIONS.

Hall

Width: 0.07 m
Length: 1.01 m
Area: 0.07 m²
Perimeter: 2.16 m

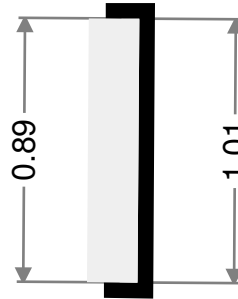

Toilet

Width: 0.89 m
Length: 1.74 m
Area: 1.56 m²
Perimeter: 5.27 m

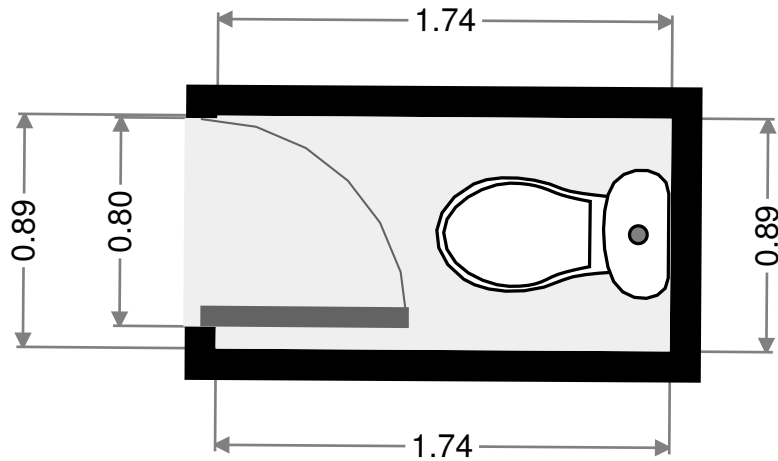
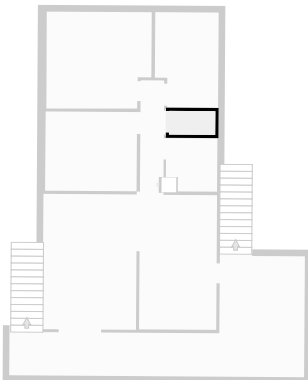

0.0 0.2 0.5 0.8 1.0 1.2m
1:29

THIS FLOORPLAN IS PROVIDED WITHOUT WARRANTY OF ANY KIND. SENSOPIA DISCLAIMS ANY WARRANTY INCLUDING, WITHOUT LIMITATION, SATISFACTORY QUALITY OR ACCURACY OF DIMENSIONS.

Bedroom

Width: 2.39 m
 Length: 3.58 m
 Area: 8.04 m²
 Perimeter: 11.94 m
 Ceiling Height: 2.17 m

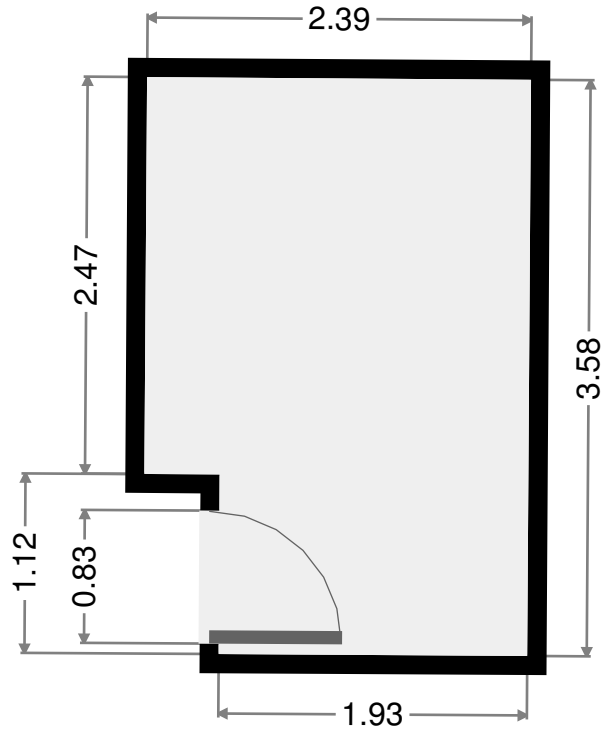
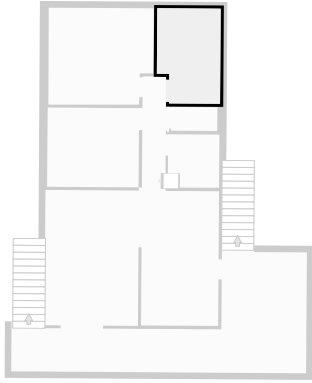

Master Bedroom

Width: 3.65 m
 Length: 3.95 m
 Area: 13.77 m²
 Perimeter: 15.17 m
 Ceiling Height: 2.17 m

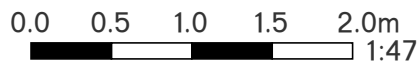
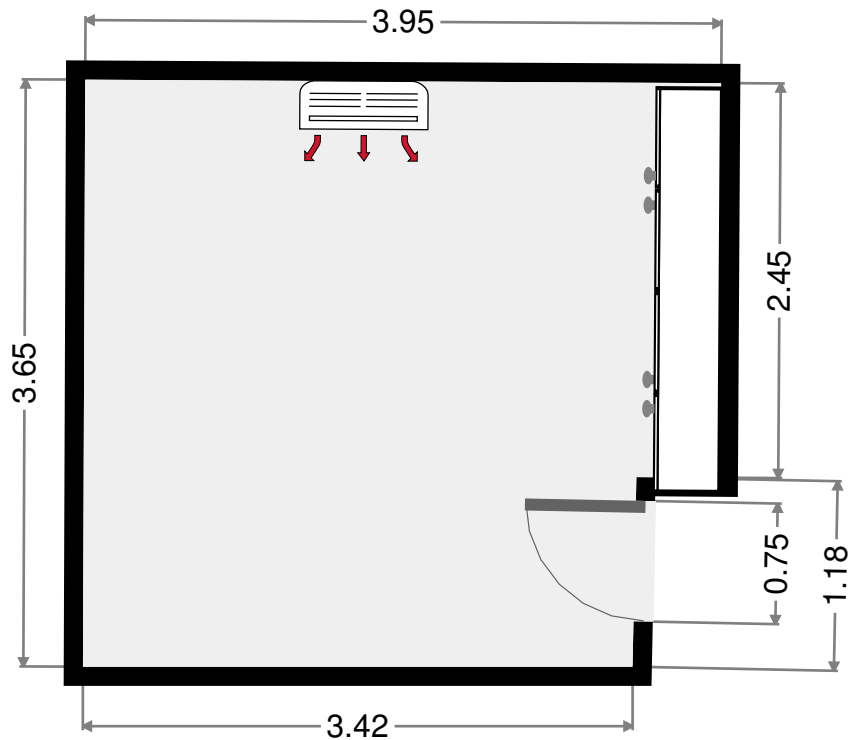
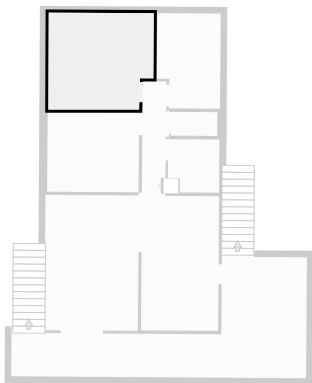

THIS FLOORPLAN IS PROVIDED WITHOUT WARRANTY OF ANY KIND. SENSOPIA DISCLAIMS ANY WARRANTY INCLUDING, WITHOUT LIMITATION, SATISFACTORY QUALITY OR ACCURACY OF DIMENSIONS.

Bedroom

Width: 2.98 m
 Length: 3.45 m
 Area: 10.28 m²
 Perimeter: 12.86 m

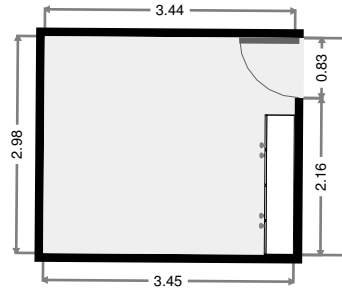
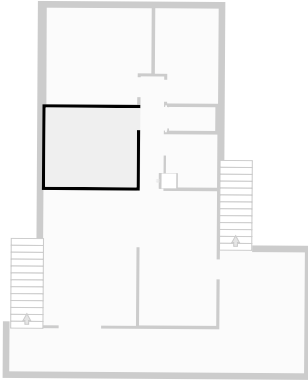

Front Balcony

Width: 4.55 m
 Length: 11.11 m
 Area: 27.50 m²
 Perimeter: 31.32 m
 Ceiling Height: 2.17 m

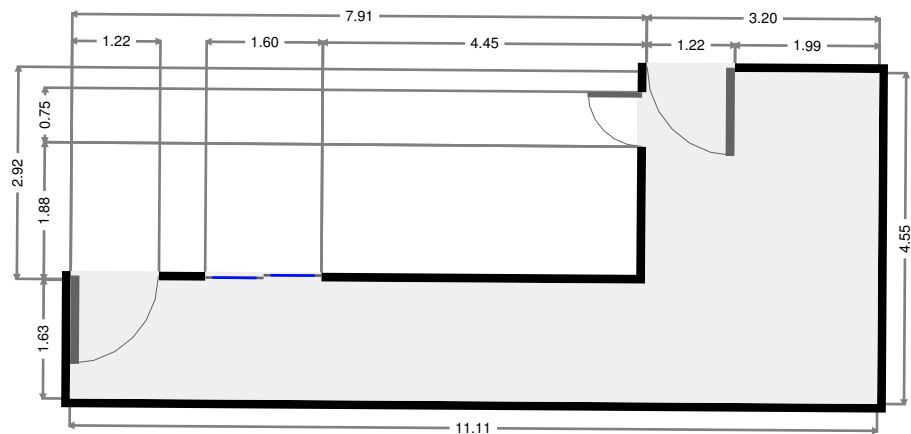
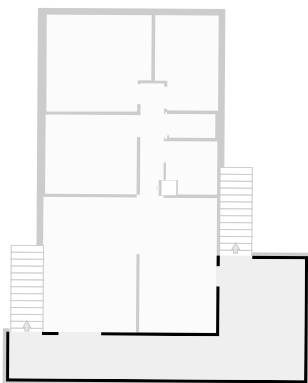

THIS FLOORPLAN IS PROVIDED WITHOUT WARRANTY OF ANY KIND. SENSOPIA DISCLAIMS ANY WARRANTY INCLUDING, WITHOUT LIMITATION, SATISFACTORY QUALITY OR ACCURACY OF DIMENSIONS.