

35 Thomasson Street

Created on
2021-05-04

Floors
2

▼ Ground Floor

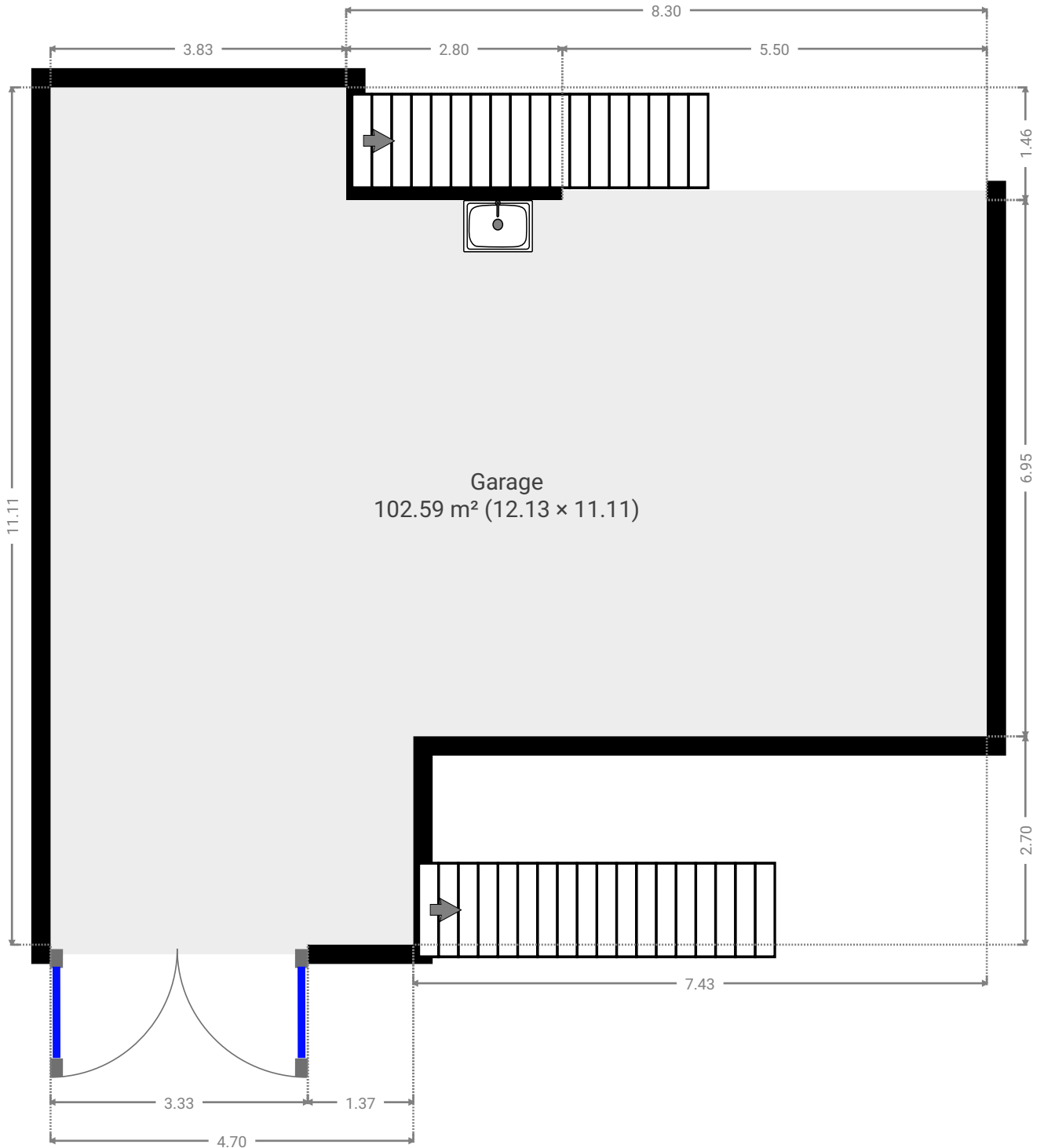

▼ Garage
Ground Floor

WIDTH: 12.13 m • LENGTH: 11.11 m
AREA: 102.59 m² • PERIMETER: 46.48 m

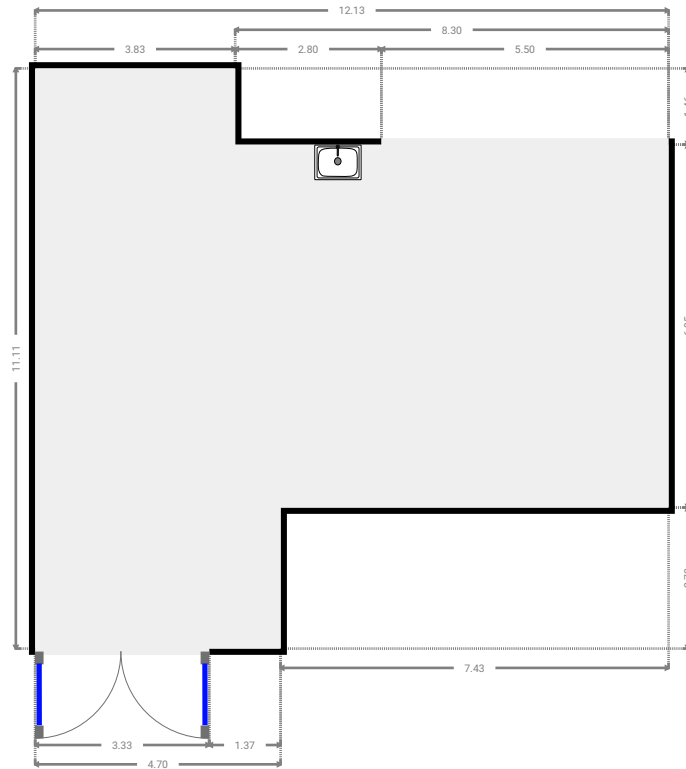
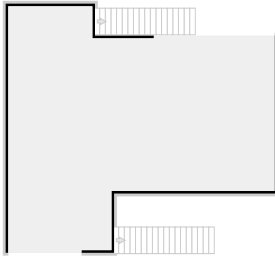

▼ 1st Floor



▼ **Living Room**
1st Floor

WIDTH: 4.70 m • LENGTH: 3.58 m
AREA: 16.83 m² • PERIMETER: 16.56 m

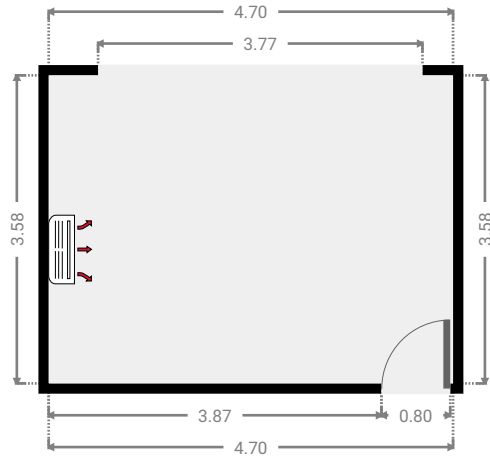
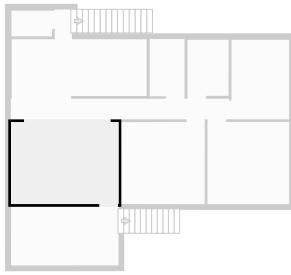

▼ **Hall**
1st Floor

WIDTH: 9.54 m • LENGTH: 0.90 m
AREA: 8.59 m² • PERIMETER: 20.88 m

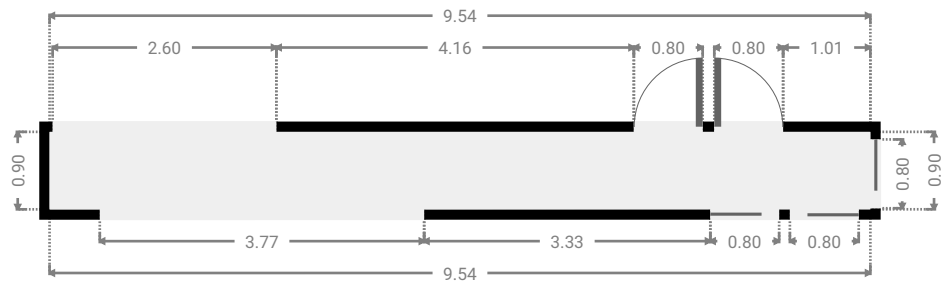
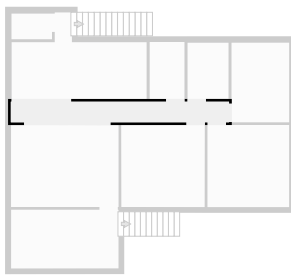

▼ **Kitchen**
1st Floor

WIDTH: 5.90 m • LENGTH: 2.48 m
AREA: 14.63 m² • PERIMETER: 16.76 m

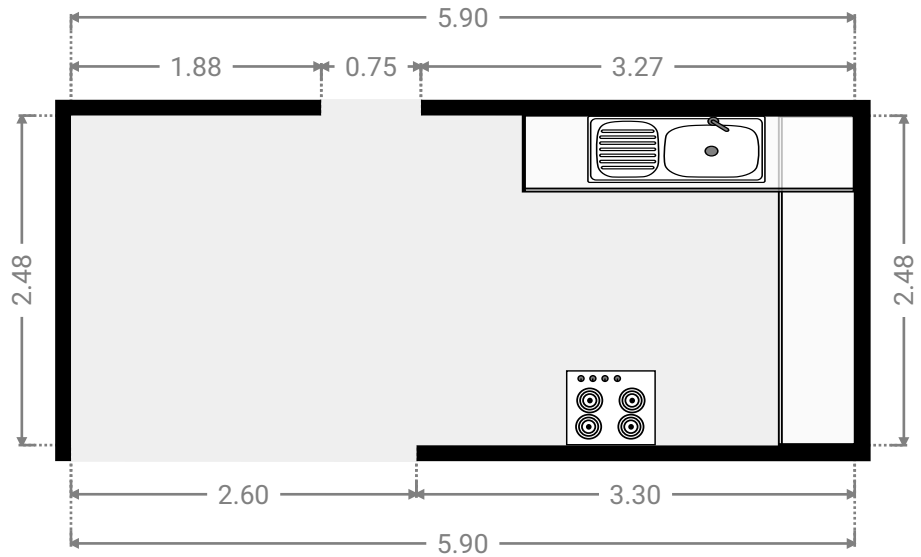
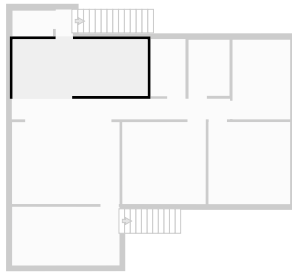

▼ **Hall**
1st Floor

WIDTH: 0.75 m • LENGTH: 1.20 m
AREA: 0.90 m² • PERIMETER: 3.90 m

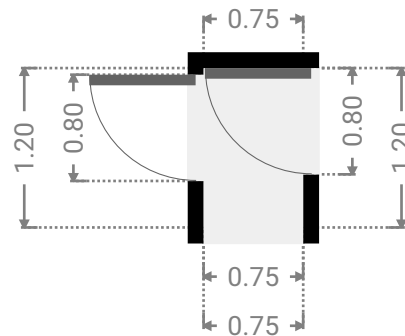
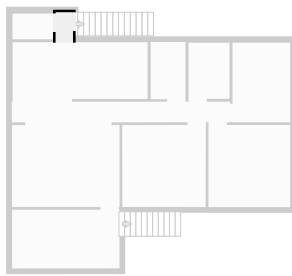

▼ **Toilet**
1st Floor

WIDTH: 1.77 m • LENGTH: 1.12 m
AREA: 1.98 m² • PERIMETER: 5.78 m

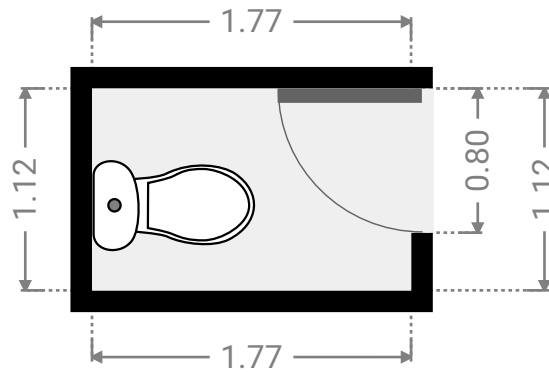
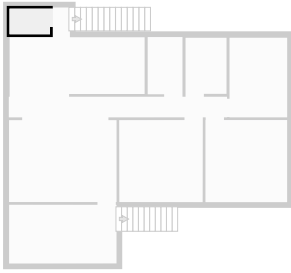

▼ **Study**
1st Floor

WIDTH: 1.52 m • LENGTH: 2.50 m
AREA: 3.80 m² • PERIMETER: 8.04 m

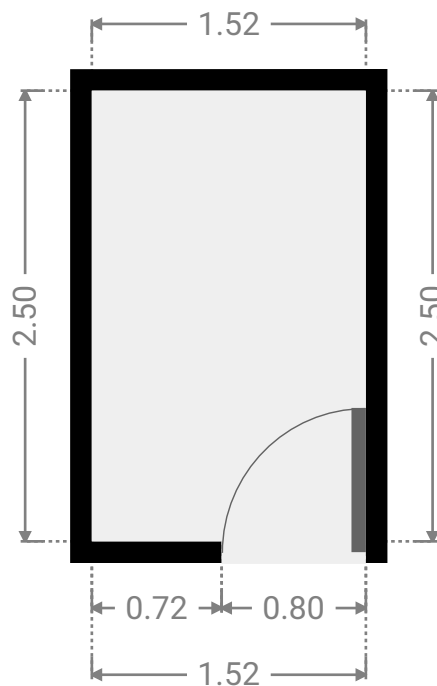
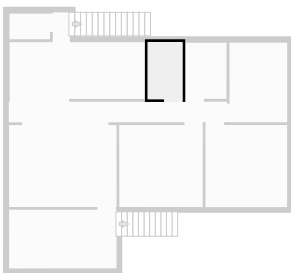

▼ Bathroom
1st Floor

WIDTH: 1.79 m • LENGTH: 2.45 m
AREA: 4.39 m² • PERIMETER: 8.48 m

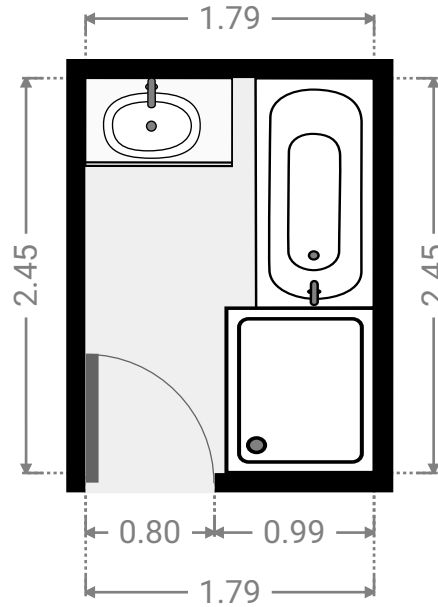
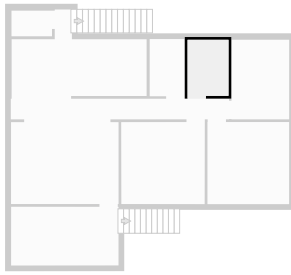

▼ Bedroom
1st Floor

WIDTH: 2.52 m • LENGTH: 3.48 m
AREA: 8.77 m² • PERIMETER: 12.00 m

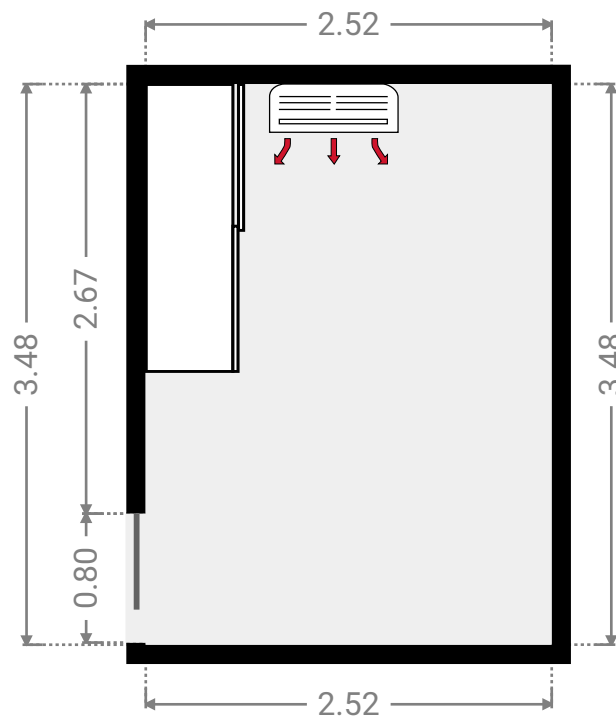
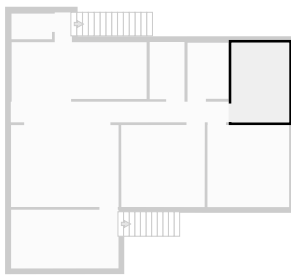

▼ **Master Bedroom**
1st Floor

WIDTH: 3.57 m • LENGTH: 3.59 m
AREA: 12.82 m² • PERIMETER: 14.32 m

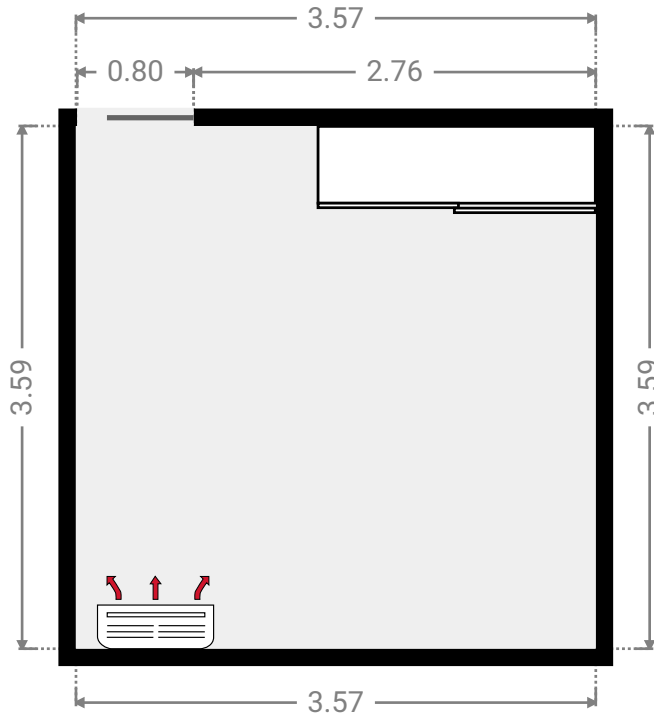
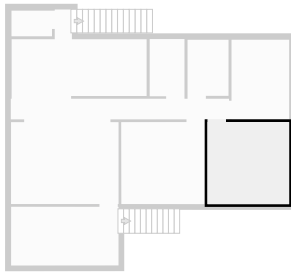

▼ **Bedroom**
1st Floor

WIDTH: 3.65 m • LENGTH: 3.59 m
AREA: 13.07 m² • PERIMETER: 14.46 m

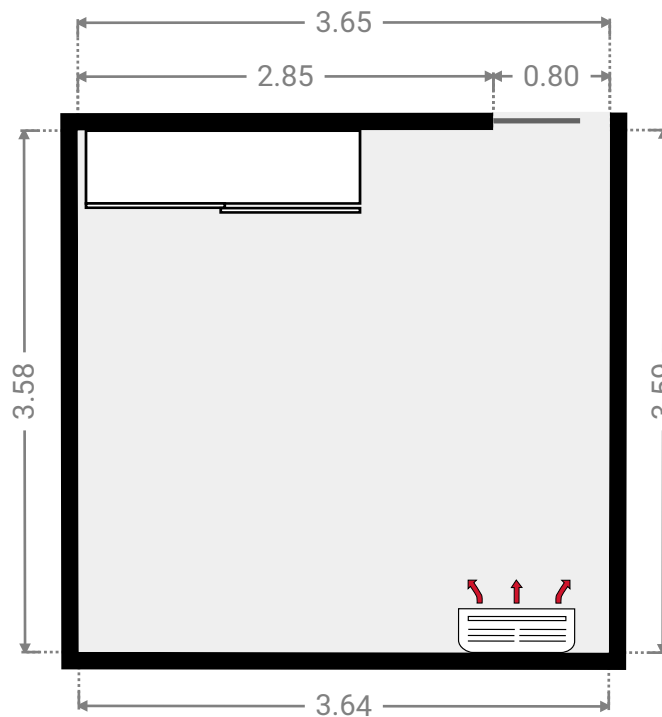
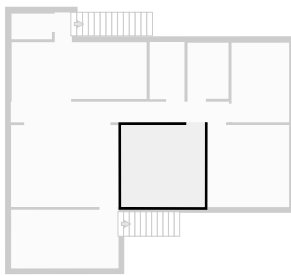

▼ Other
1st Floor

WIDTH: 4.70 m • LENGTH: 2.57 m
AREA: 12.04 m² • PERIMETER: 14.52 m

