

348 Fenlon Avenue

Ground Floor

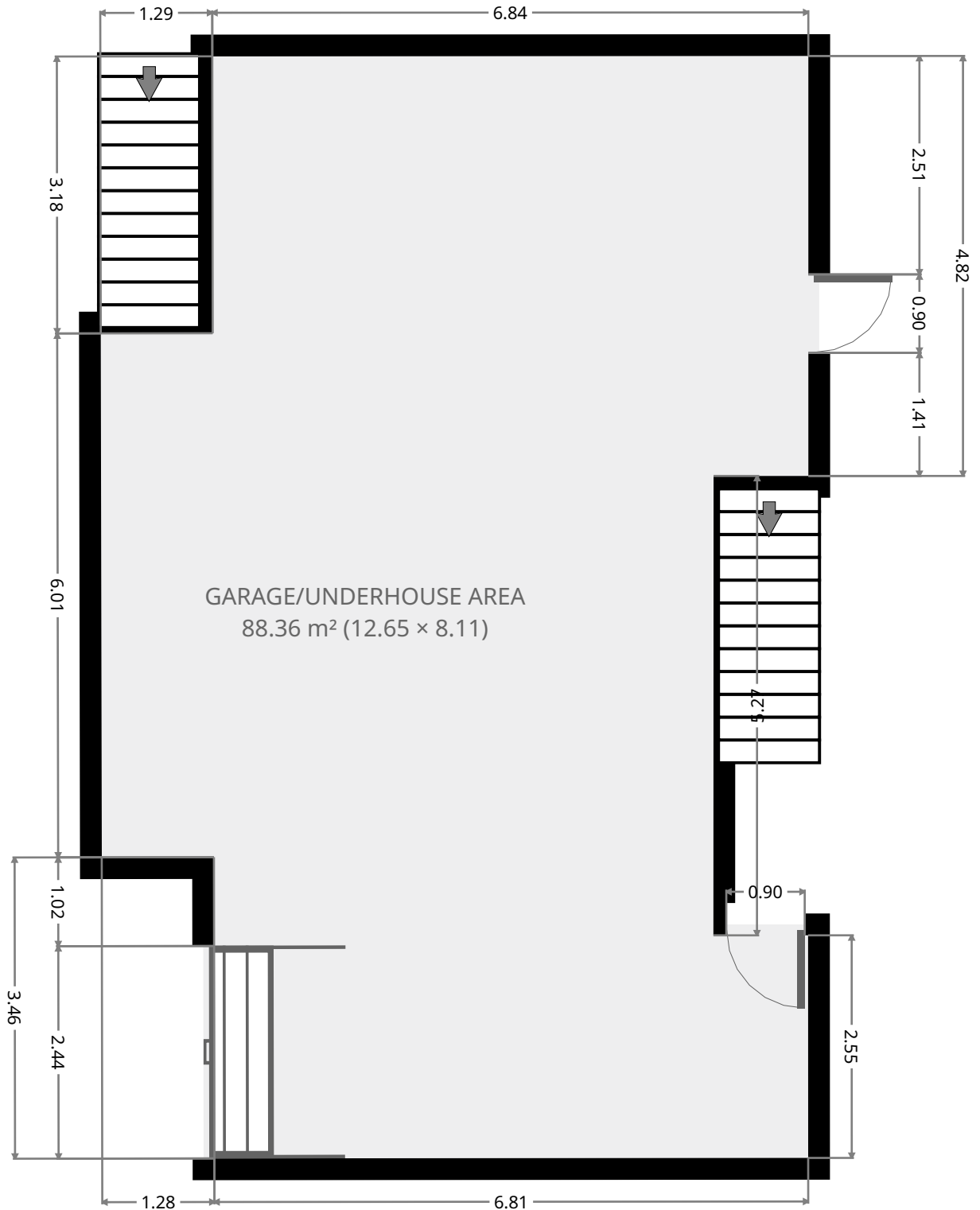

THIS FLOORPLAN IS PROVIDED WITHOUT WARRANTY OF ANY KIND. SENSOPIA DISCLAIMS ANY WARRANTY INCLUDING, WITHOUT LIMITATION, SATISFACTORY QUALITY OR ACCURACY OF DIMENSIONS.

348 Fenlon Avenue

Garage/Underhouse Area

Width: 8.11 m
Length: 12.65 m
Area: 88.36 m²
Perimeter: 43.70 m

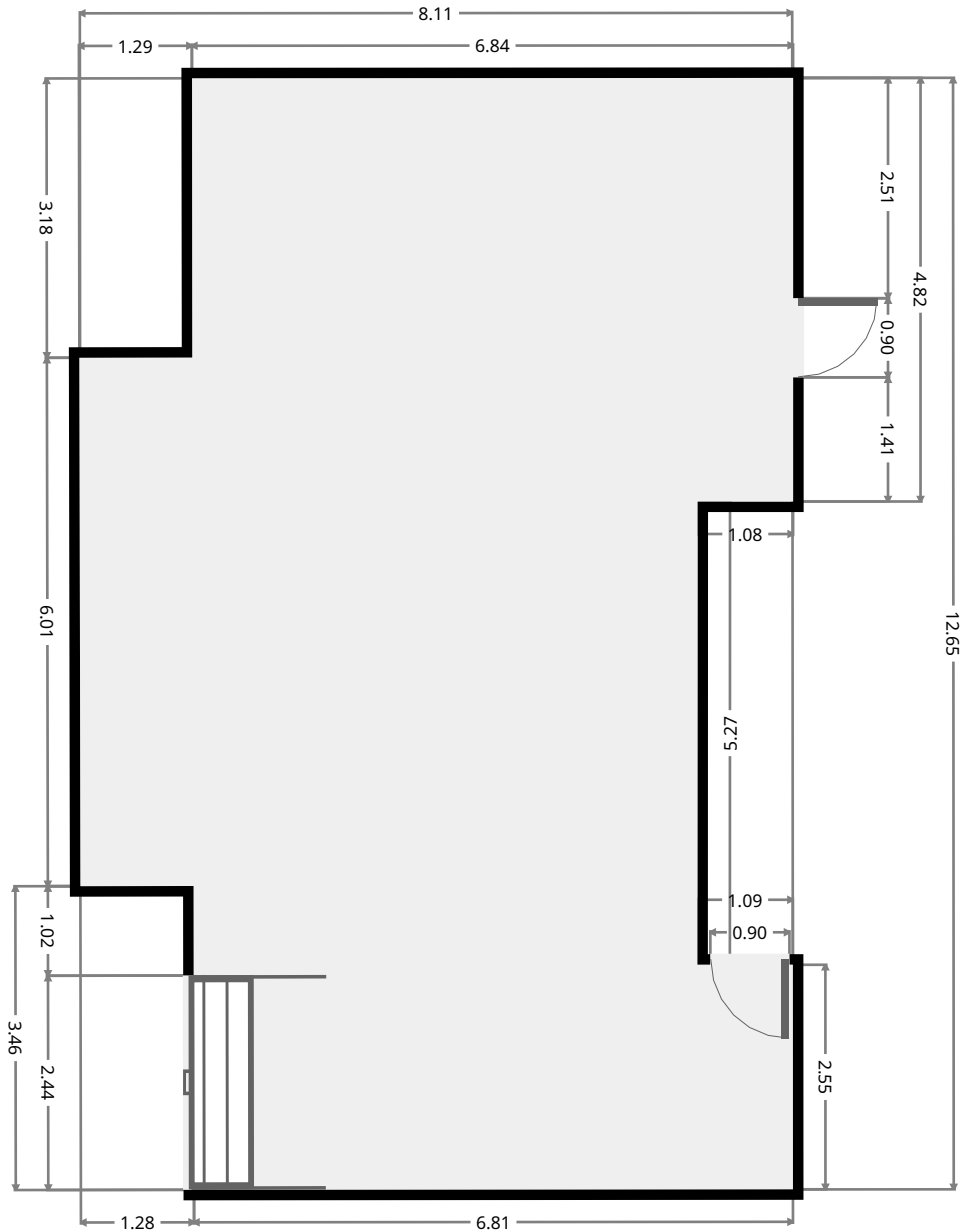
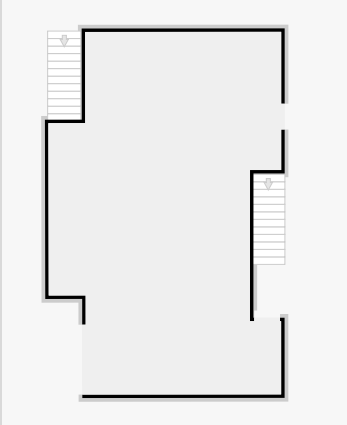

THIS FLOORPLAN IS PROVIDED WITHOUT WARRANTY OF ANY KIND. SENSOPIA DISCLAIMS ANY WARRANTY INCLUDING, WITHOUT LIMITATION, SATISFACTORY QUALITY OR ACCURACY OF DIMENSIONS.



348 Fenlon Avenue

1st Floor

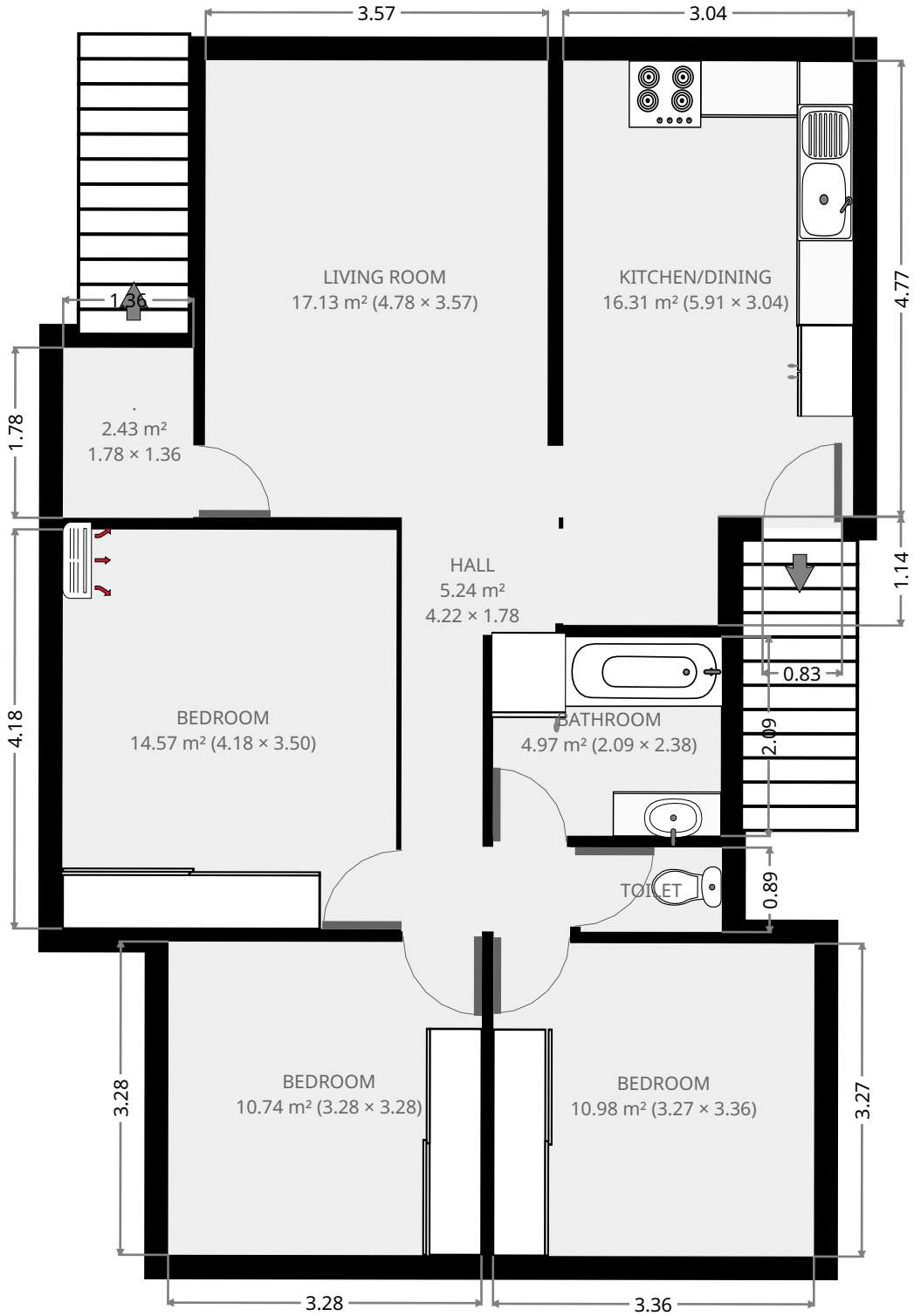

THIS FLOORPLAN IS PROVIDED WITHOUT WARRANTY OF ANY KIND. SENSOPIA DISCLAIMS ANY WARRANTY INCLUDING, WITHOUT LIMITATION, SATISFACTORY QUALITY OR ACCURACY OF DIMENSIONS.



348 Fenlon Avenue

Living Room

Width: 3.57 m
 Length: 4.78 m
 Area: 17.13 m²
 Perimeter: 16.73 m

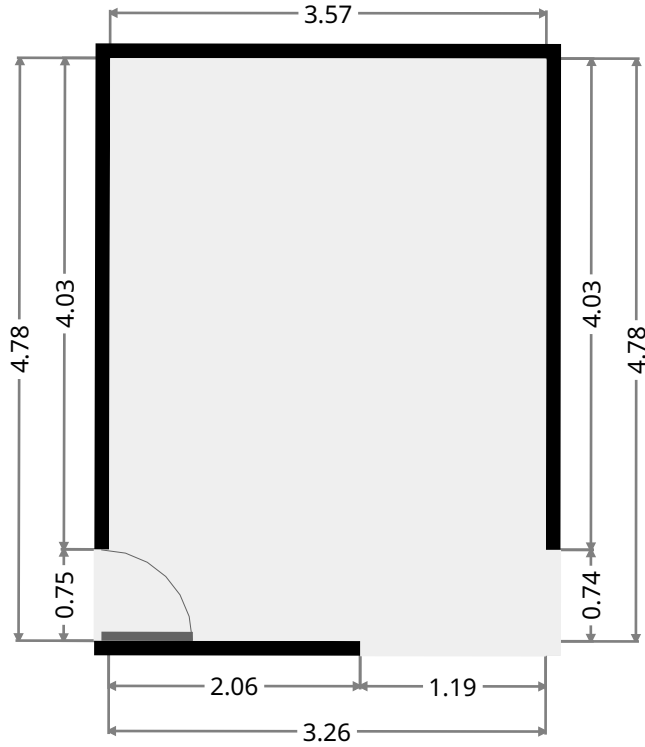
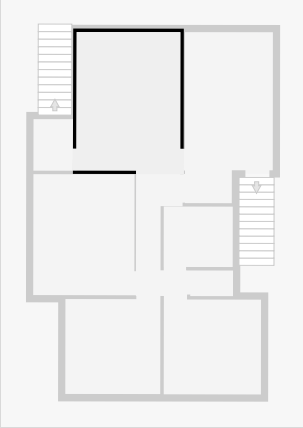

Hall

Width: 1.78 m
 Length: 4.22 m
 Area: 5.24 m²
 Perimeter: 13.48 m

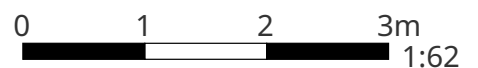
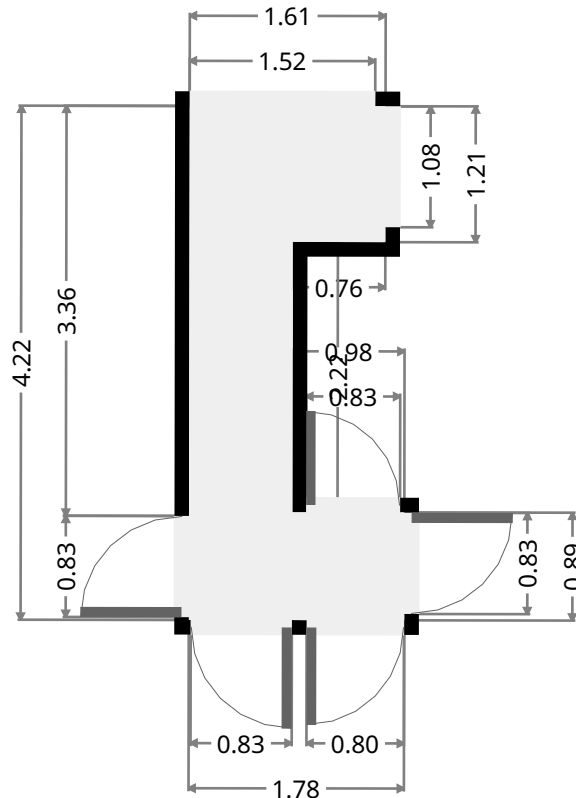
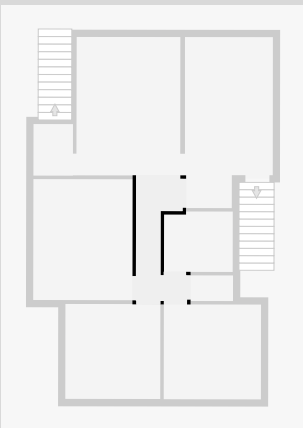

THIS FLOORPLAN IS PROVIDED WITHOUT WARRANTY OF ANY KIND. SENSOPIA DISCLAIMS ANY WARRANTY INCLUDING, WITHOUT LIMITATION, SATISFACTORY QUALITY OR ACCURACY OF DIMENSIONS.

348 Fenlon Avenue

Kitchen/Dining

Width: 3.04 m
Length: 5.91 m
Area: 16.31 m²
Perimeter: 17.88 m

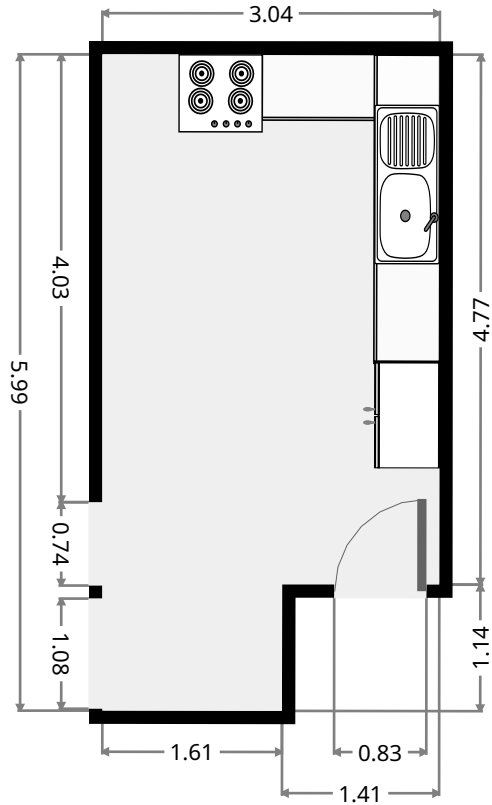
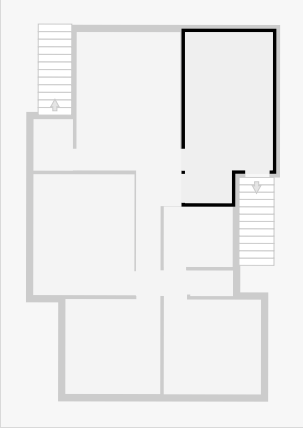

Bathroom

Width: 2.09 m
Length: 2.38 m
Area: 4.97 m²
Perimeter: 8.93 m

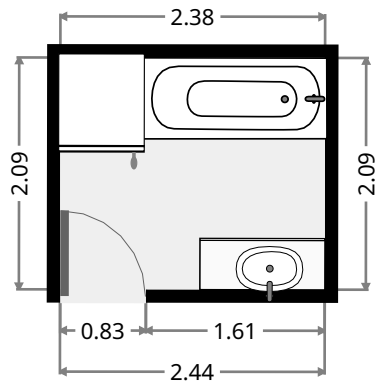
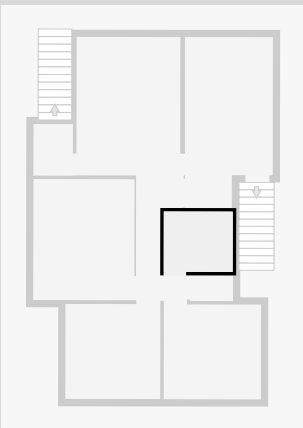

348 Fenlon Avenue

Bedroom

Width: 3.50 m
 Length: 4.18 m
 Area: 14.57 m²
 Perimeter: 15.33 m

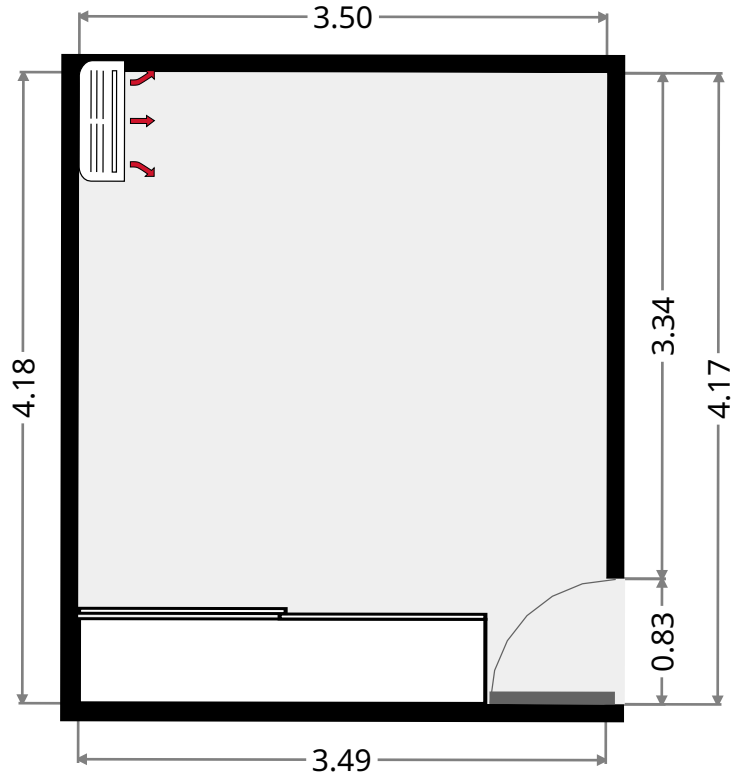
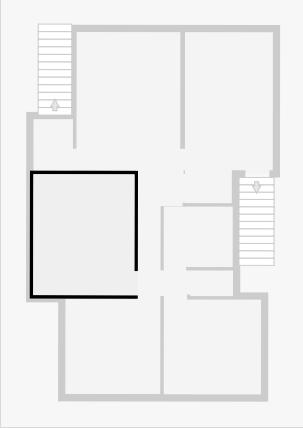

Bedroom

Width: 3.28 m
 Length: 3.28 m
 Area: 10.74 m²
 Perimeter: 13.11 m

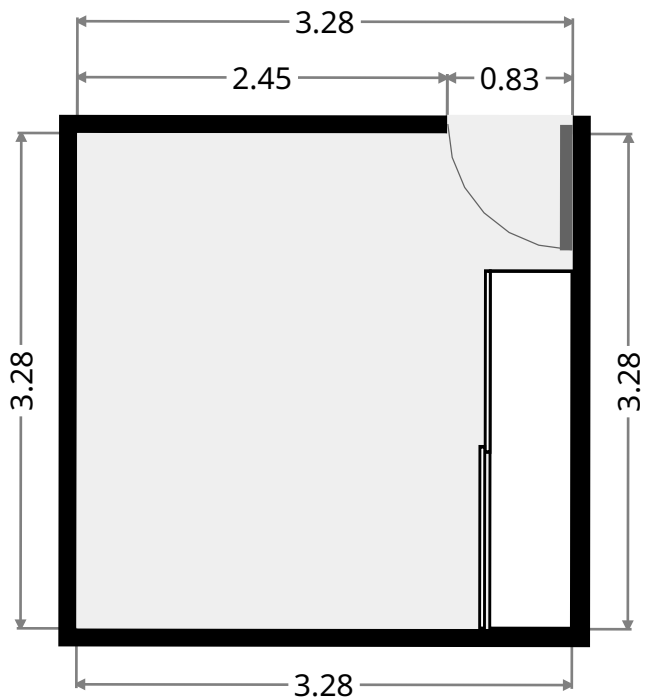
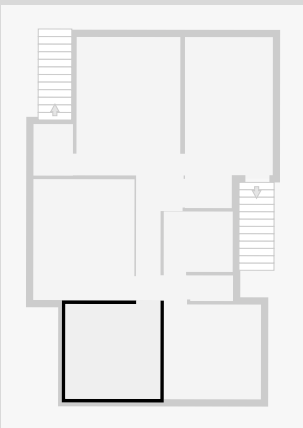

348 Fenlon Avenue

Bedroom

Width: 3.27 m
Length: 3.36 m
Area: 10.98 m²
Perimeter: 13.26 m

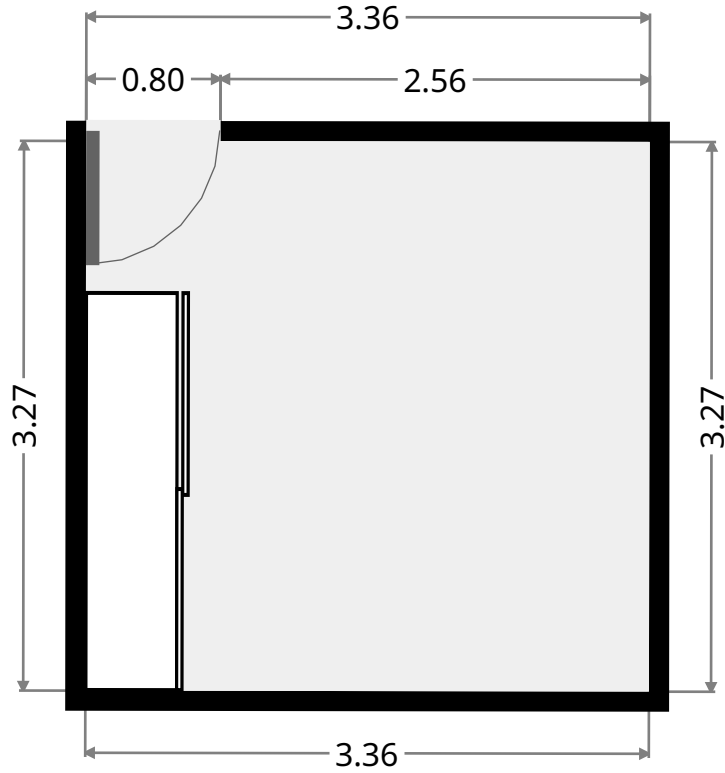
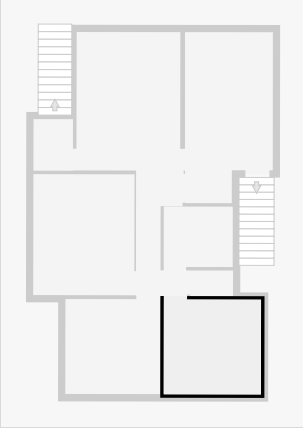

Toilet

Width: 0.88 m
Length: 1.48 m
Area: 1.30 m²
Perimeter: 4.72 m

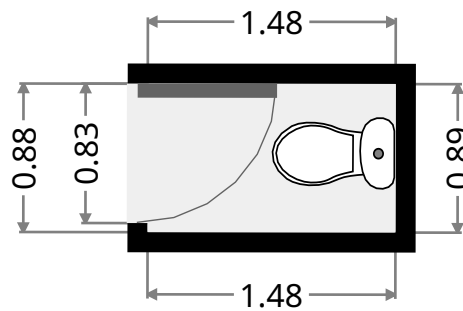
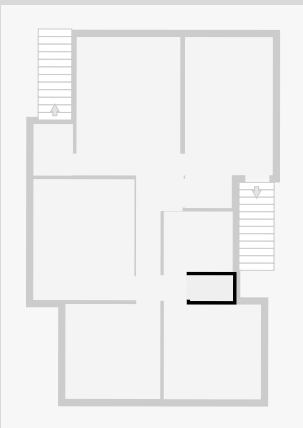

348 Fenlon Avenue

•
Width: 1.36 m
Length: 1.78 m
Area: 2.43 m²
Perimeter: 6.29 m

