

343 Rockonia Road

Ground Floor

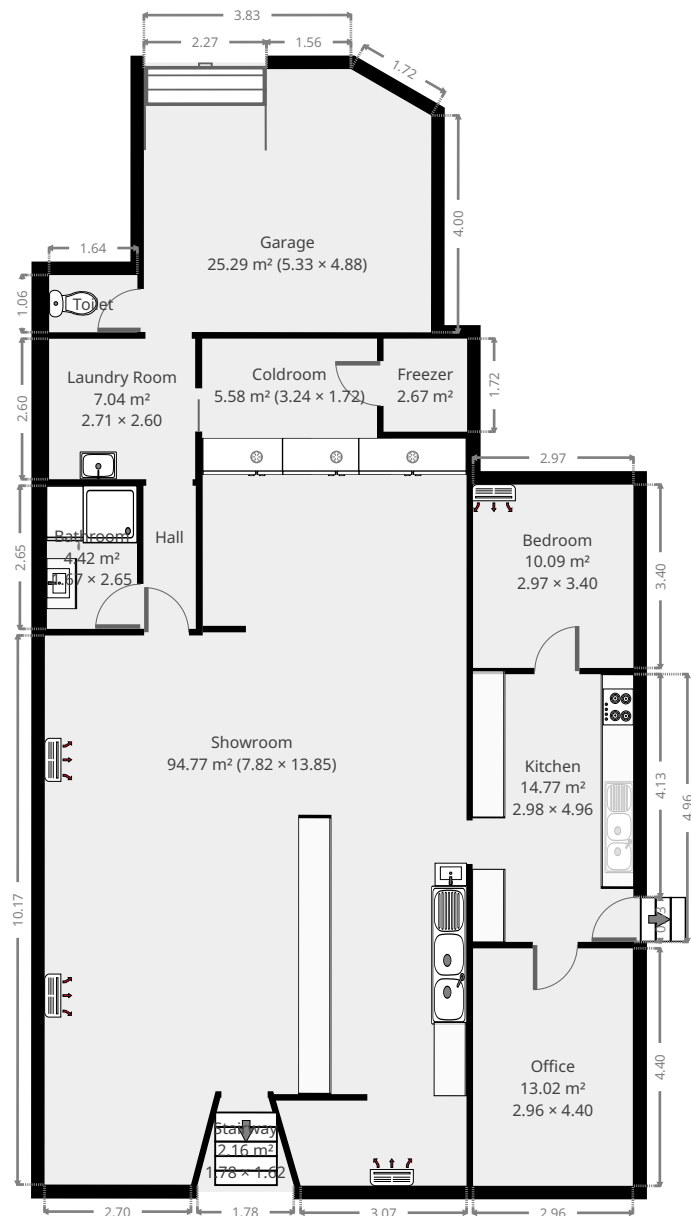
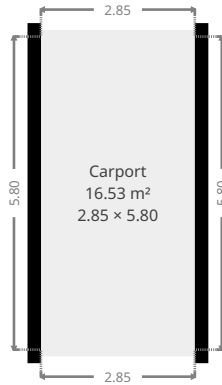

THIS FLOORPLAN IS PROVIDED WITHOUT WARRANTY OF ANY KIND. SENSOPIA DISCLAIMS ANY WARRANTY INCLUDING, WITHOUT LIMITATION, SATISFACTORY QUALITY OR ACCURACY OF DIMENSIONS.

343 Rockonia Road

Showroom

Width: 7.82 m
Length: 13.85 m
Area: 94.77 m²
Perimeter: 45.96 m

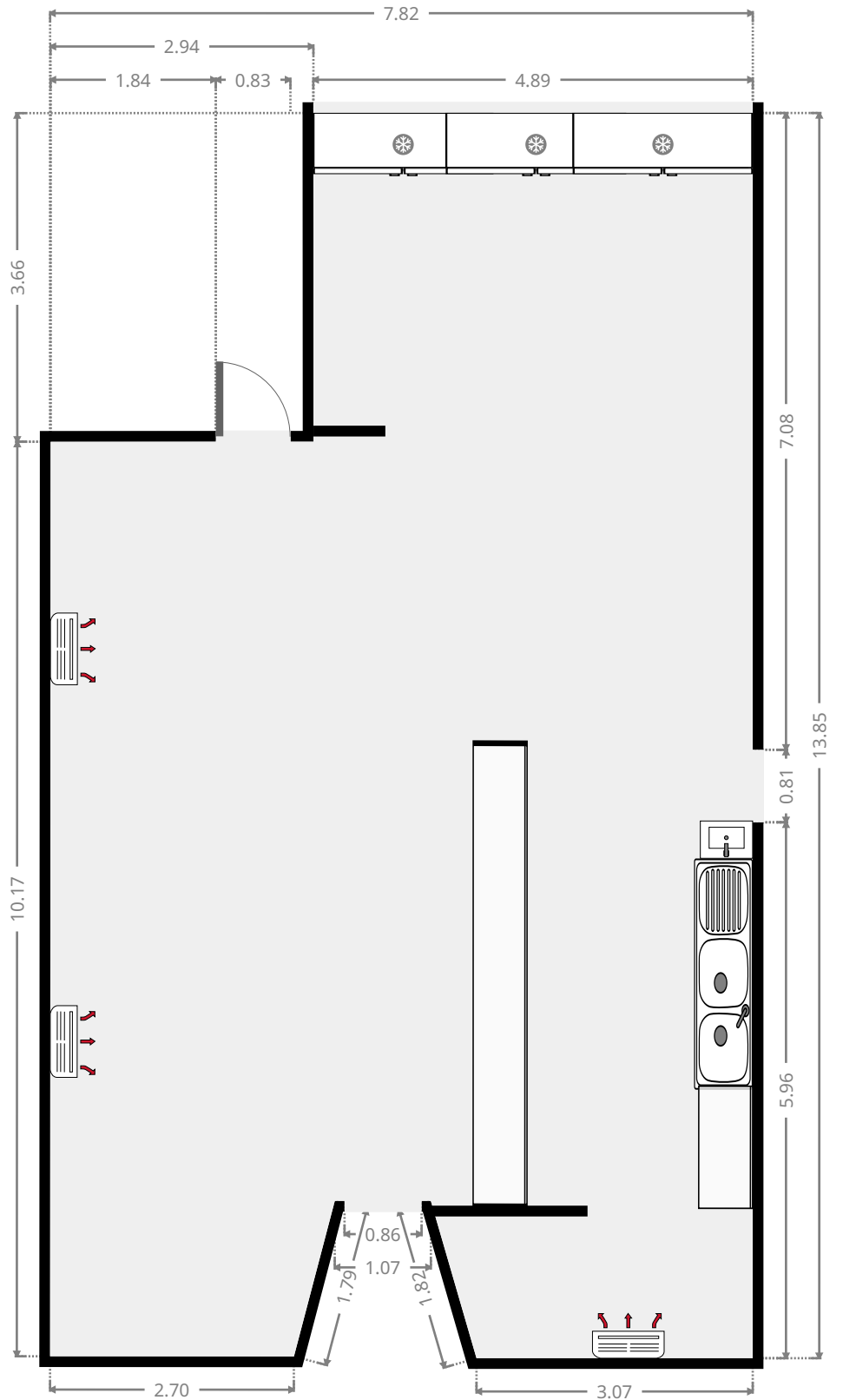
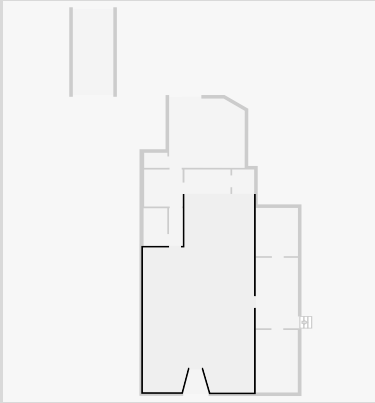

THIS FLOORPLAN IS PROVIDED WITHOUT WARRANTY OF ANY KIND. SENSOPIA DISCLAIMS ANY WARRANTY INCLUDING, WITHOUT LIMITATION, SATISFACTORY QUALITY OR ACCURACY OF DIMENSIONS.



343 Rockonia Road

Stairway

Width: 1.62 m
Length: 1.78 m
Area: 2.16 m²
Perimeter: 6.03 m

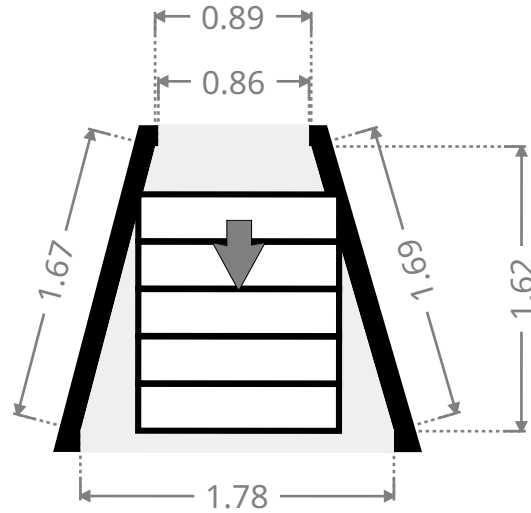
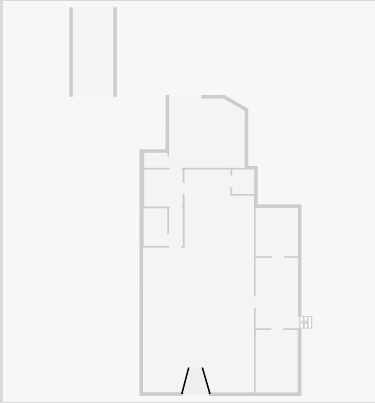

Hall

Width: 0.97 m
Length: 2.65 m
Area: 2.57 m²
Perimeter: 7.24 m

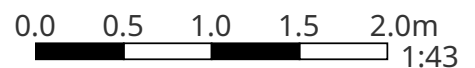
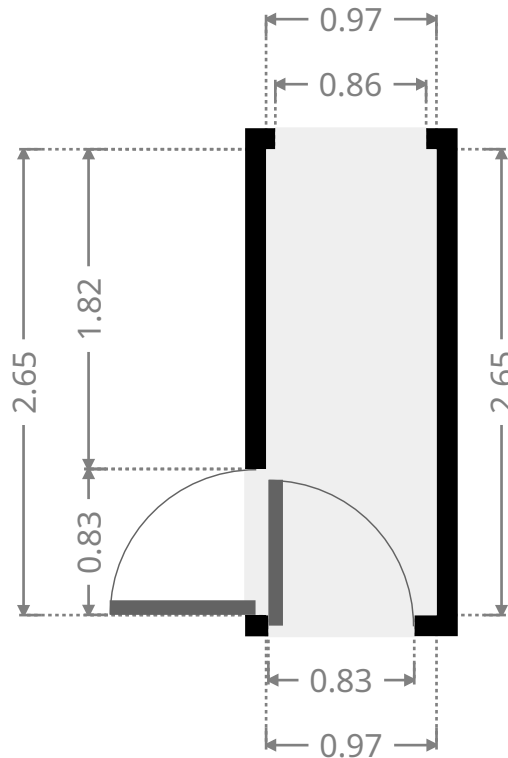
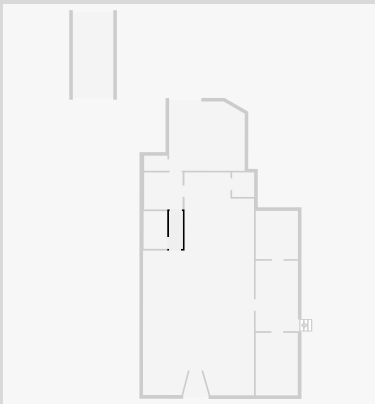

343 Rockonia Road

Bathroom

Width: 1.67 m
Length: 2.65 m
Area: 4.42 m²
Perimeter: 8.64 m

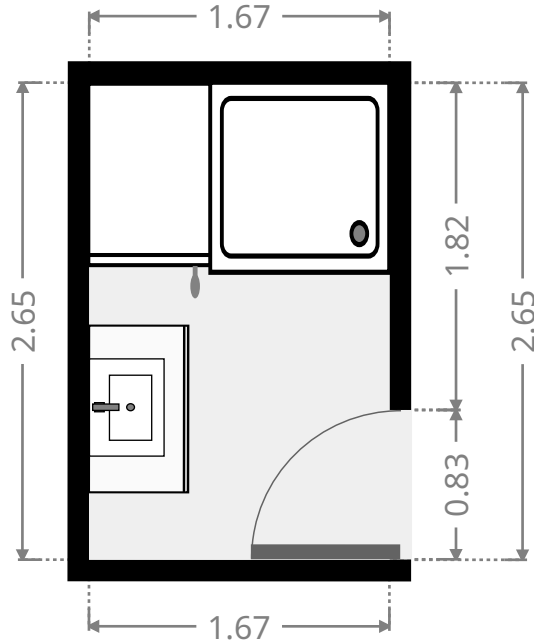
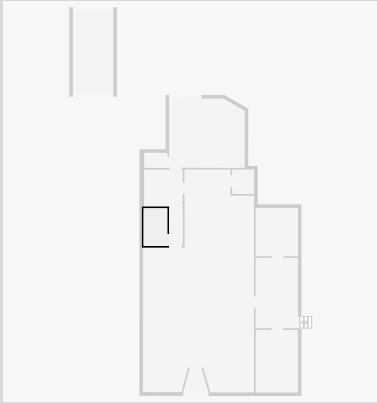

Laundry Room

Width: 2.60 m
Length: 2.71 m
Area: 7.04 m²
Perimeter: 10.62 m

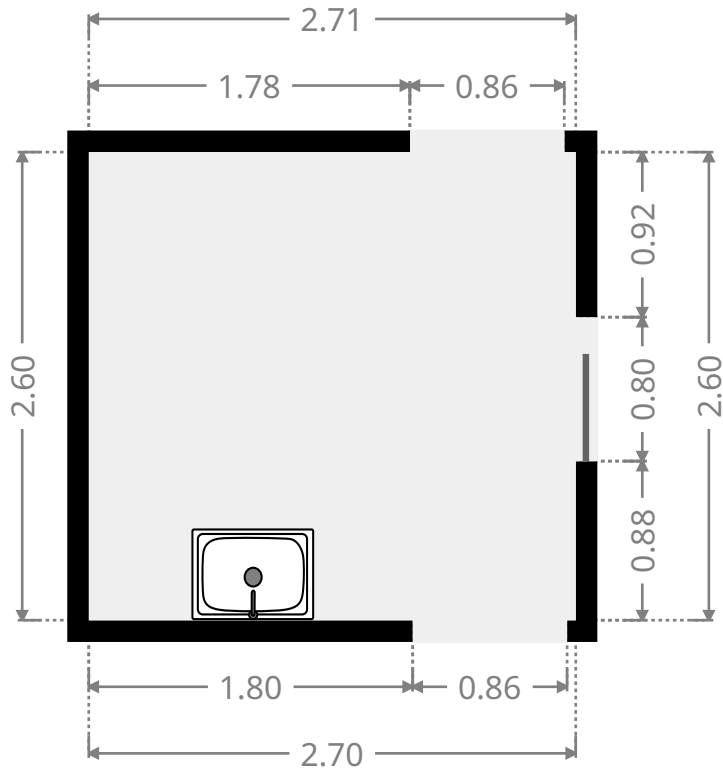
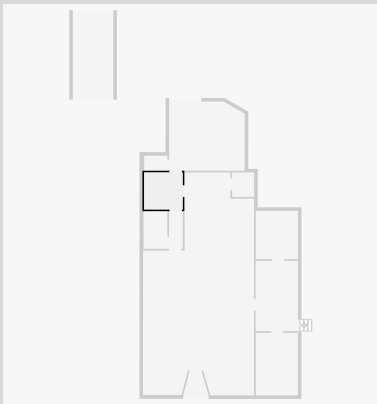

THIS FLOORPLAN IS PROVIDED WITHOUT WARRANTY OF ANY KIND. SENSOPIA DISCLAIMS ANY WARRANTY INCLUDING, WITHOUT LIMITATION, SATISFACTORY QUALITY OR ACCURACY OF DIMENSIONS.

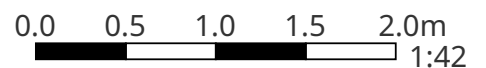

343 Rockonia Road

Coldroom

Width: 1.72 m
Length: 3.24 m
Area: 5.58 m²
Perimeter: 9.92 m

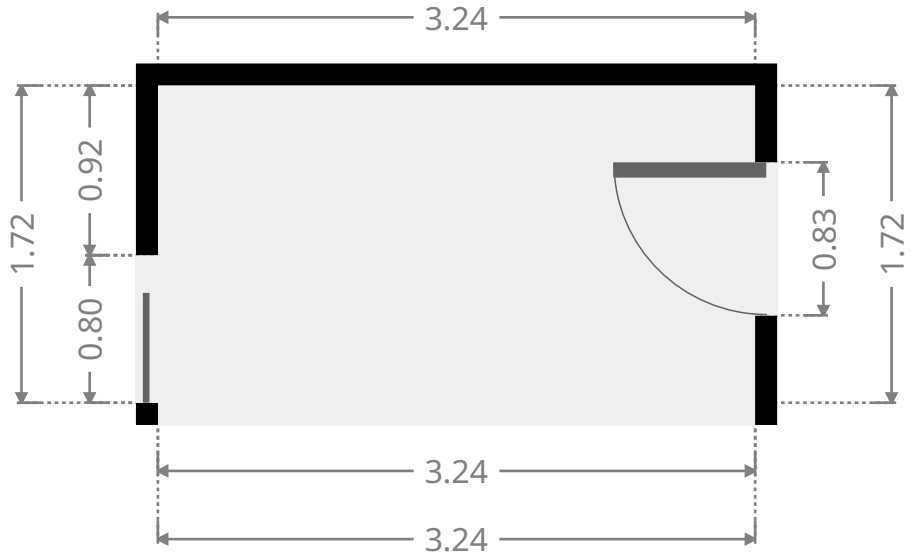
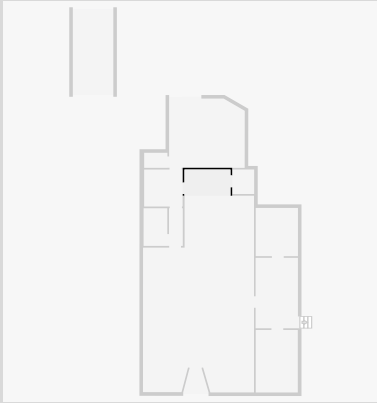

Freezer

Width: 1.55 m
Length: 1.72 m
Area: 2.67 m²
Perimeter: 6.54 m

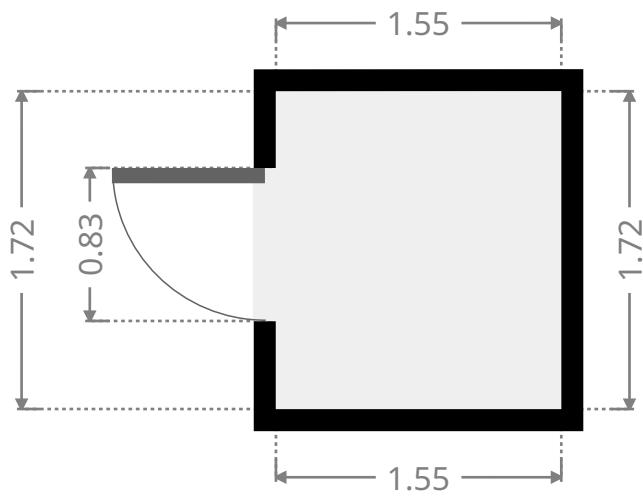
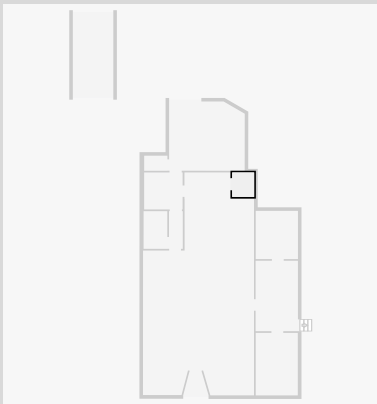

343 Rockonia Road

Garage

Width: 4.88 m
 Length: 5.33 m
 Area: 25.29 m²
 Perimeter: 19.76 m

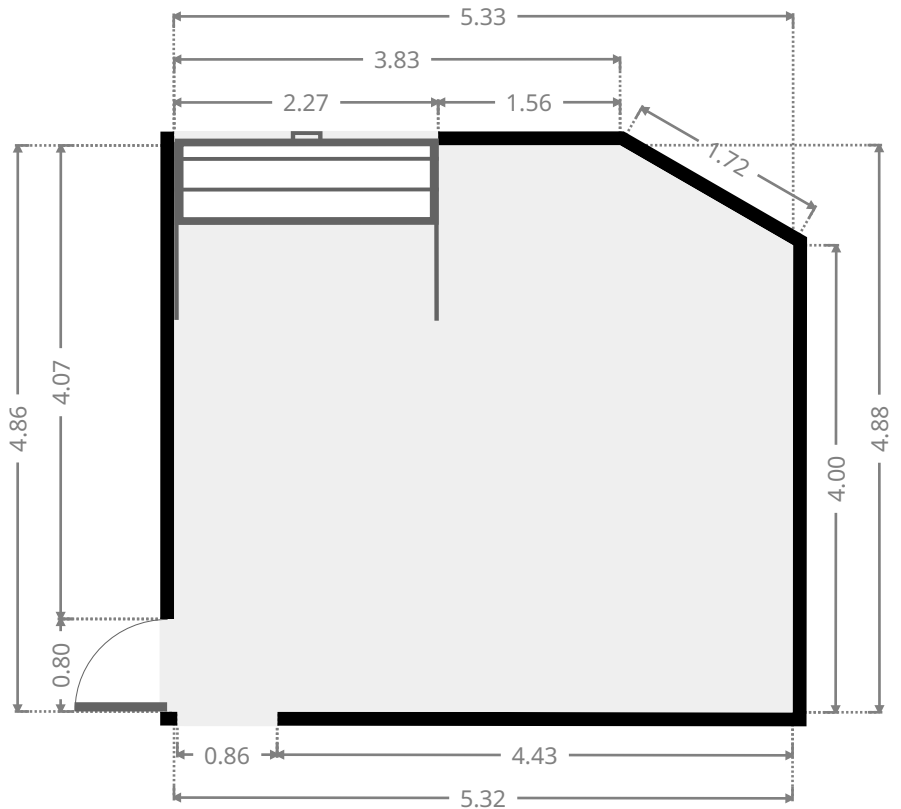
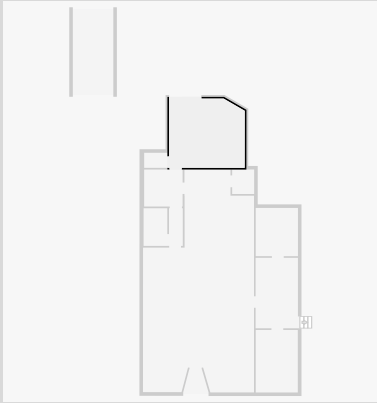

Toilet / Half Bath

Width: 1.06 m
 Length: 1.64 m
 Area: 1.73 m²
 Perimeter: 5.39 m

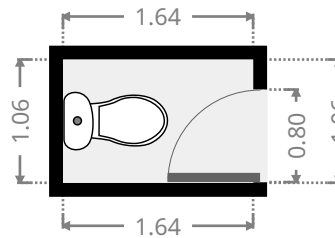
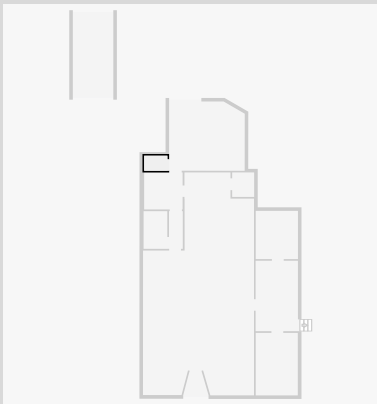

343 Rockonia Road

Office

Width: 2.96 m
Length: 4.40 m
Area: 13.02 m²
Perimeter: 14.72 m

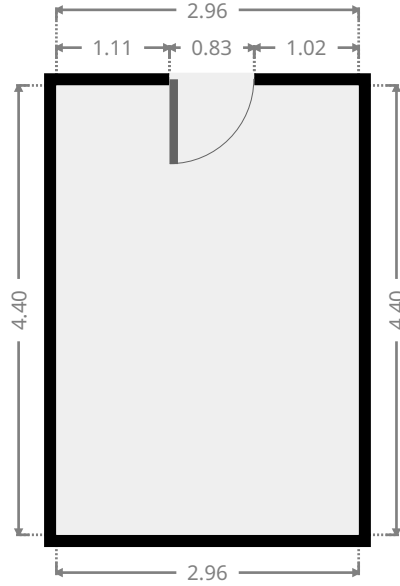
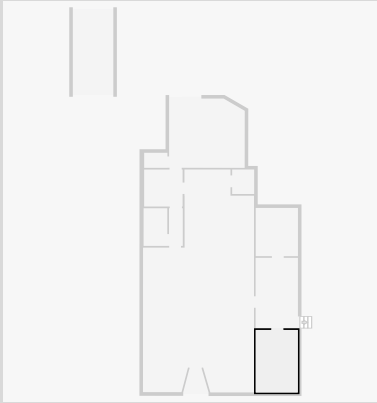

Kitchen

Width: 2.98 m
Length: 4.96 m
Area: 14.77 m²
Perimeter: 15.88 m

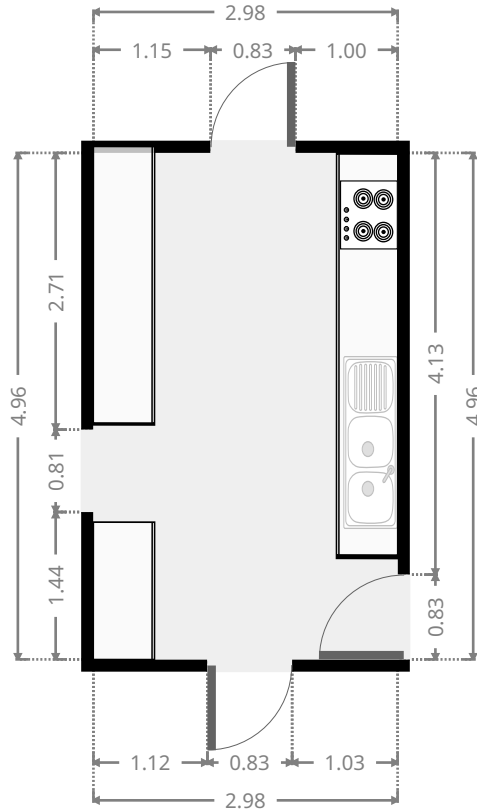
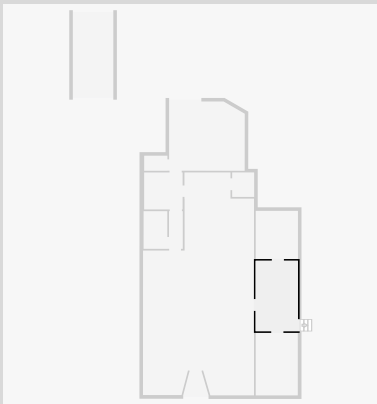

THIS FLOORPLAN IS PROVIDED WITHOUT WARRANTY OF ANY KIND. SENSOPIA DISCLAIMS ANY WARRANTY INCLUDING, WITHOUT LIMITATION, SATISFACTORY QUALITY OR ACCURACY OF DIMENSIONS.

343 Rockonia Road

Bedroom

Width: 2.97 m
Length: 3.40 m
Area: 10.09 m²
Perimeter: 12.73 m

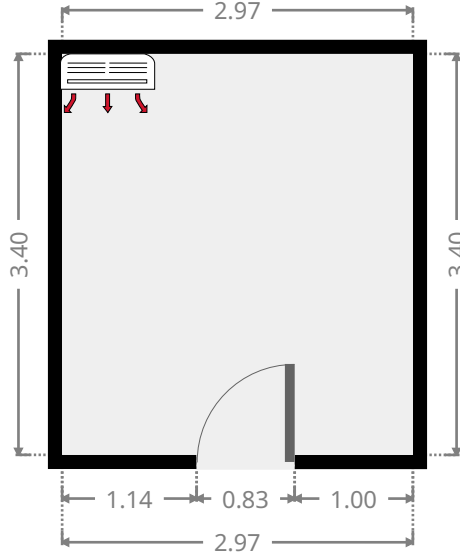
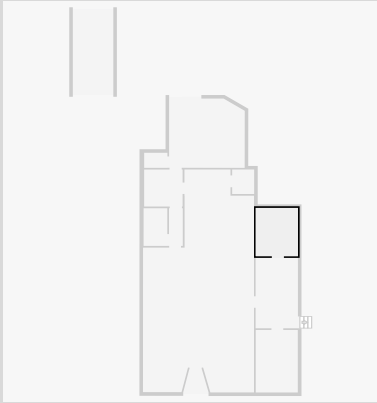

Carport

Width: 2.85 m
Length: 5.80 m
Area: 16.53 m²
Perimeter: 17.30 m

