

# 342 George Street

## Ground Floor

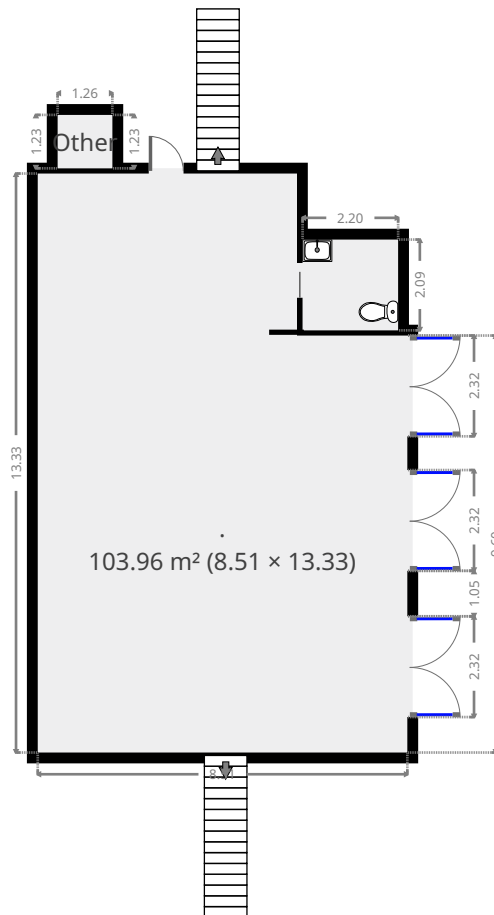

THIS FLOORPLAN IS PROVIDED WITHOUT WARRANTY OF ANY KIND. SENSOPIA DISCLAIMS ANY WARRANTY INCLUDING, WITHOUT LIMITATION, SATISFACTORY QUALITY OR ACCURACY OF DIMENSIONS.

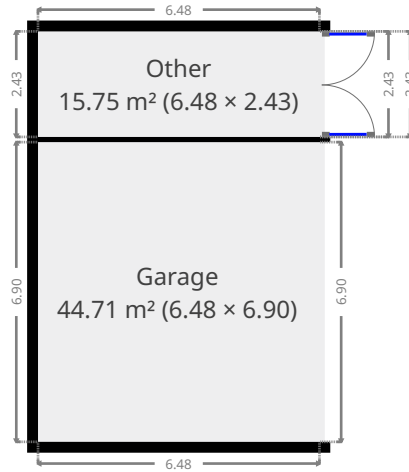

# 342 George Street

Width: 8.51 m  
Length: 13.33 m  
Area: 103.96 m<sup>2</sup>  
Perimeter: 43.68 m

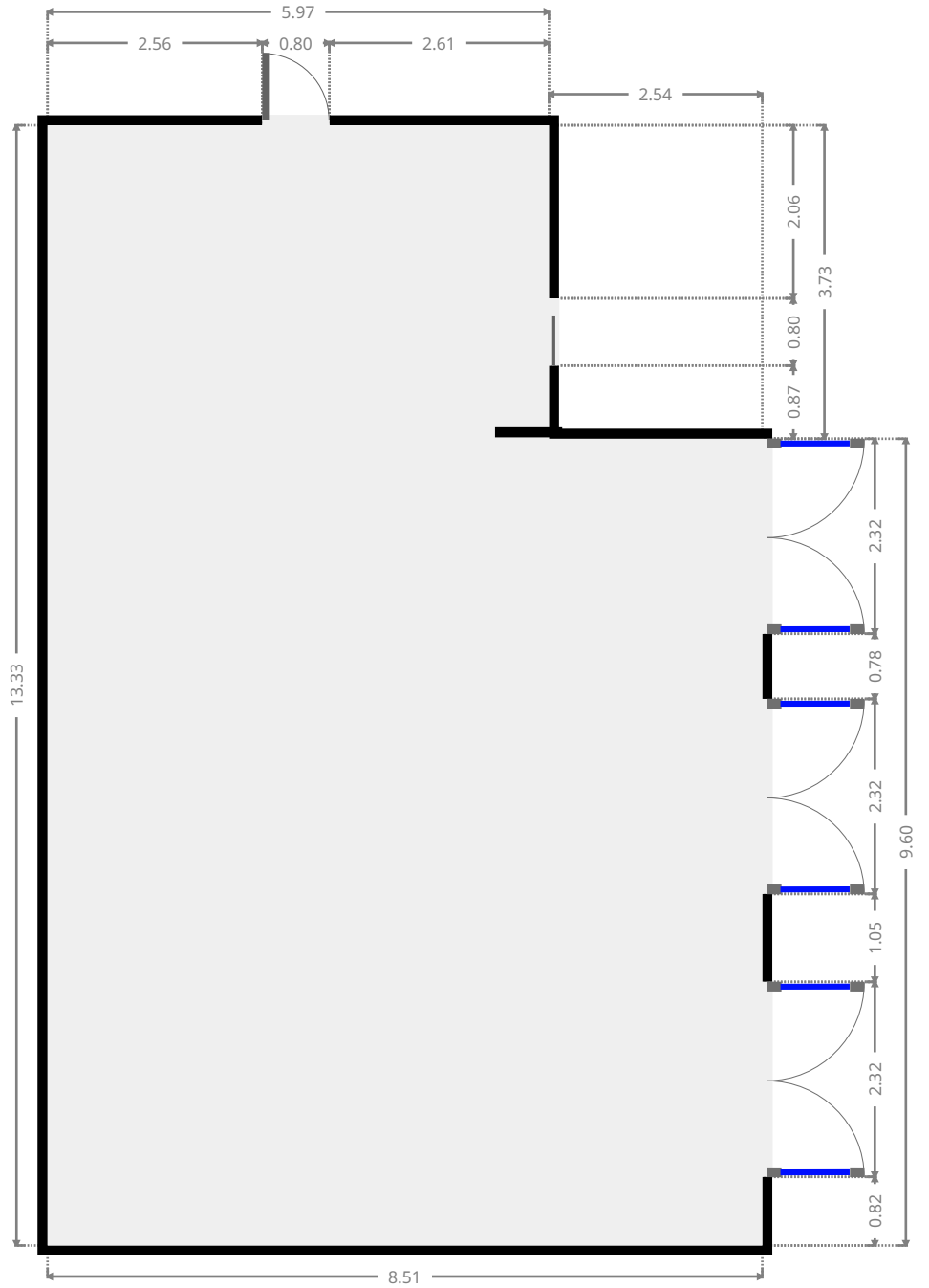
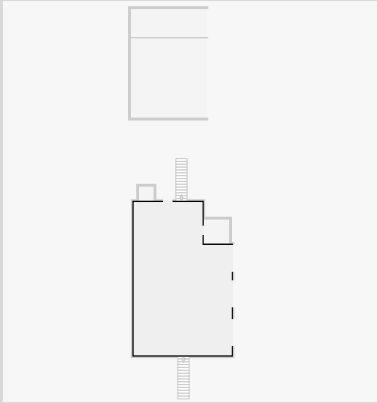

THIS FLOORPLAN IS PROVIDED WITHOUT WARRANTY OF ANY KIND. SENSOPIA DISCLAIMS ANY WARRANTY INCLUDING, WITHOUT LIMITATION, SATISFACTORY QUALITY OR ACCURACY OF DIMENSIONS.



# 342 George Street

## Laundry Room

Width: 2.09 m  
Length: 2.20 m  
Area: 4.60 m<sup>2</sup>  
Perimeter: 8.58 m

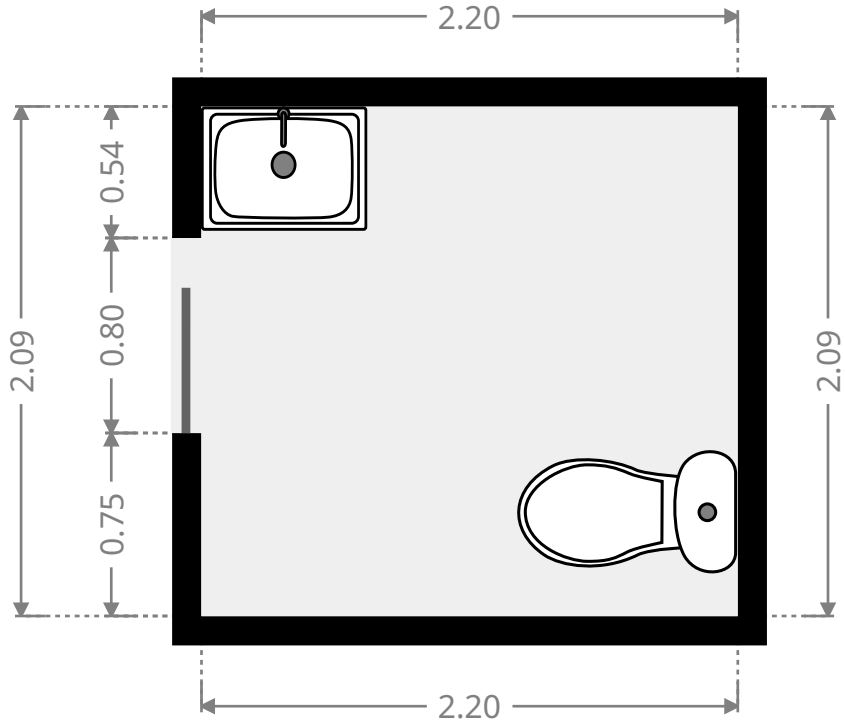
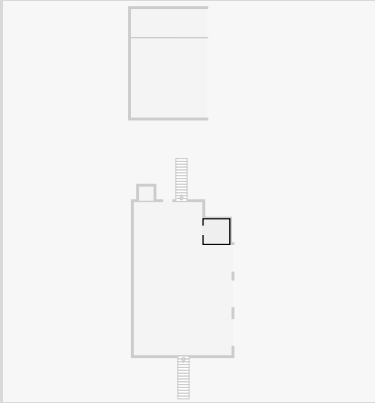

## Other

Width: 1.23 m  
Length: 1.26 m  
Area: 1.55 m<sup>2</sup>  
Perimeter: 4.98 m

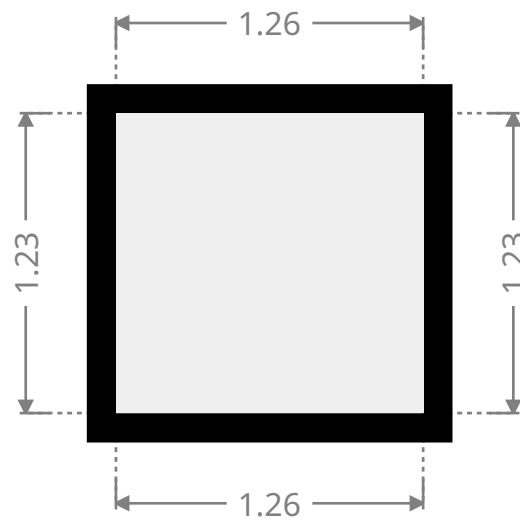
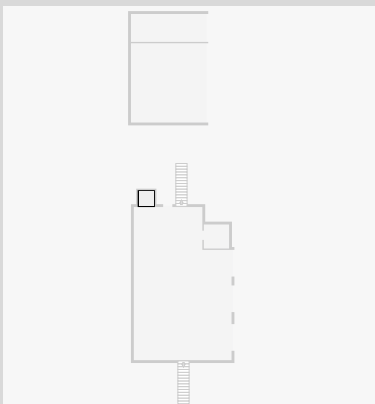

# 342 George Street

## Garage

Width: 6.48 m  
Length: 6.90 m  
Area: 44.71 m<sup>2</sup>  
Perimeter: 26.76 m

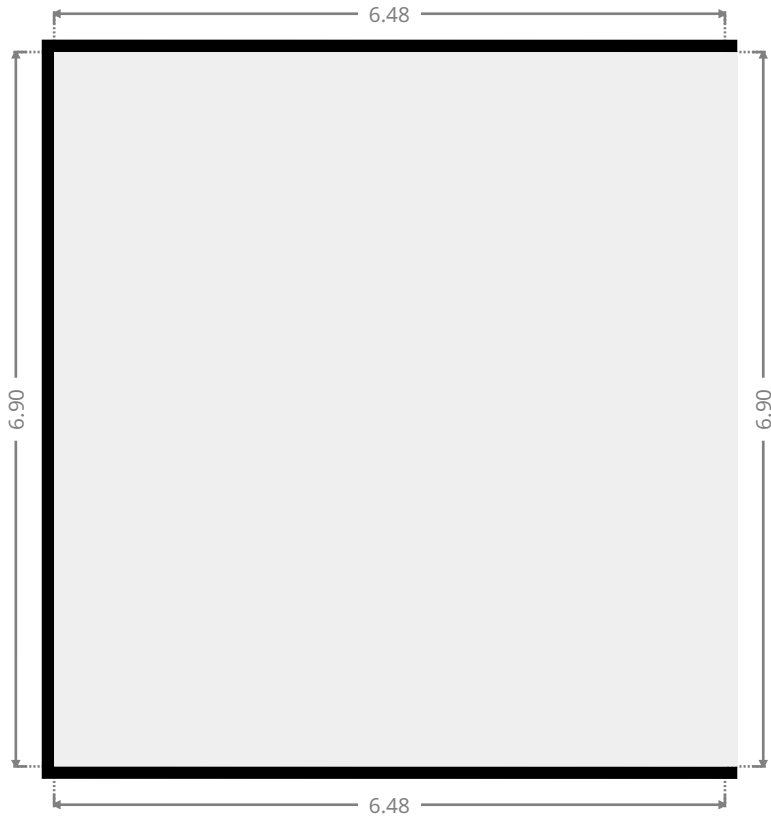
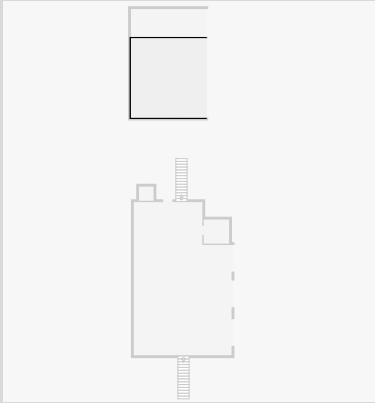

## Other

Width: 2.43 m  
Length: 6.48 m  
Area: 15.75 m<sup>2</sup>  
Perimeter: 17.82 m

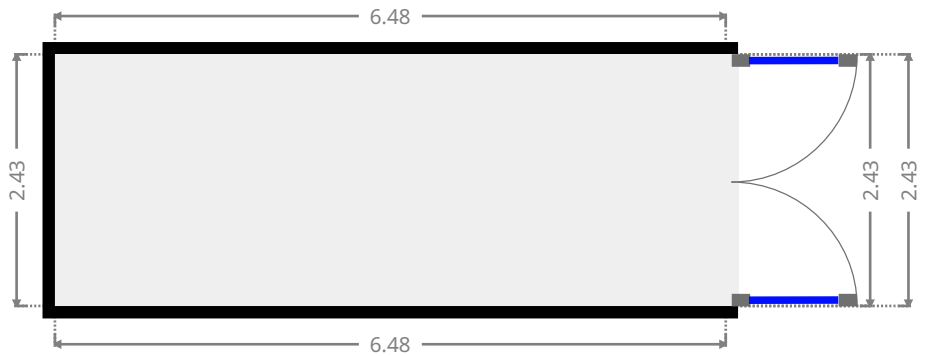
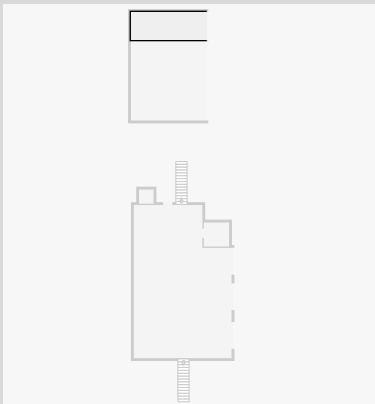

# 342 George Street

## 1st Floor

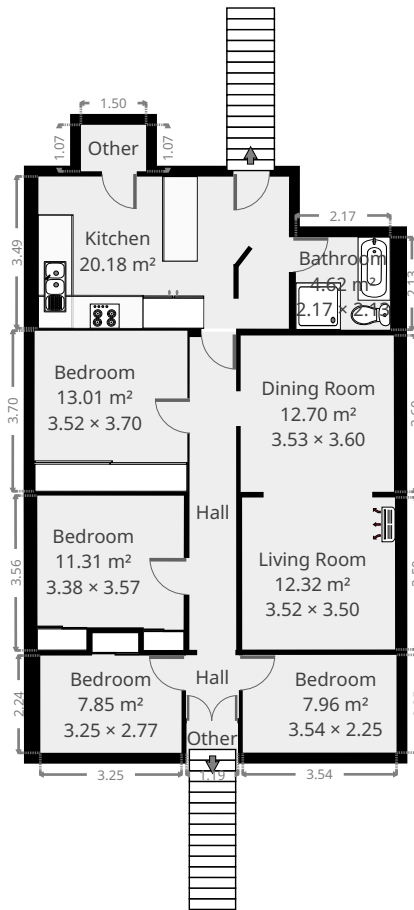

THIS FLOORPLAN IS PROVIDED WITHOUT WARRANTY OF ANY KIND. SENSOPIA DISCLAIMS ANY WARRANTY INCLUDING, WITHOUT LIMITATION, SATISFACTORY QUALITY OR ACCURACY OF DIMENSIONS.



# 342 George Street

## Hall

Width: 1.22 m  
 Length: 1.45 m  
 Area: 1.77 m<sup>2</sup>  
 Perimeter: 5.34 m

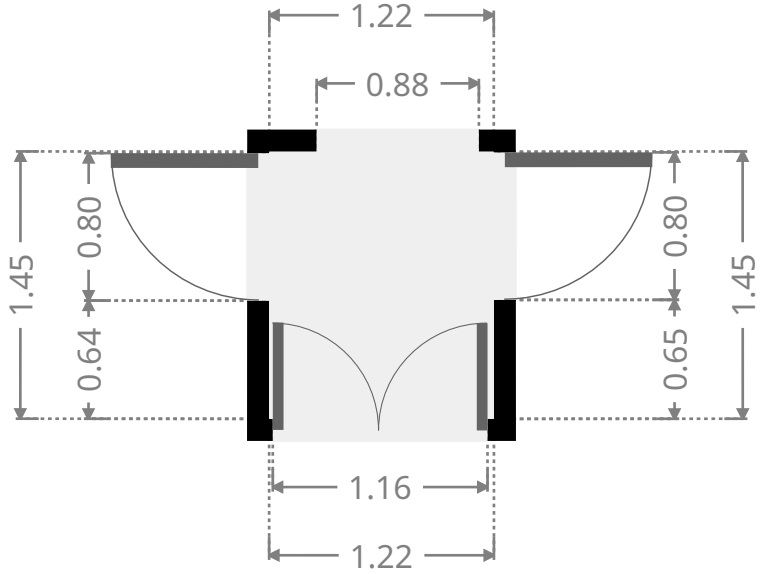
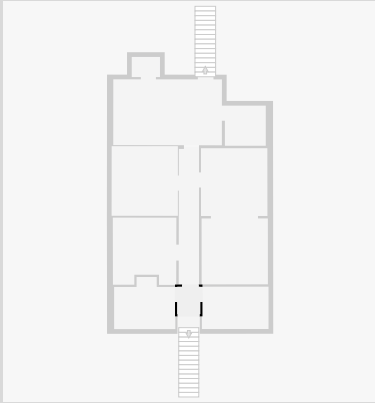

## Bedroom

Width: 2.77 m  
 Length: 3.25 m  
 Area: 7.85 m<sup>2</sup>  
 Perimeter: 12.04 m

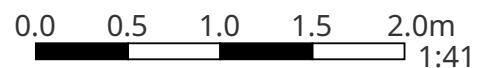
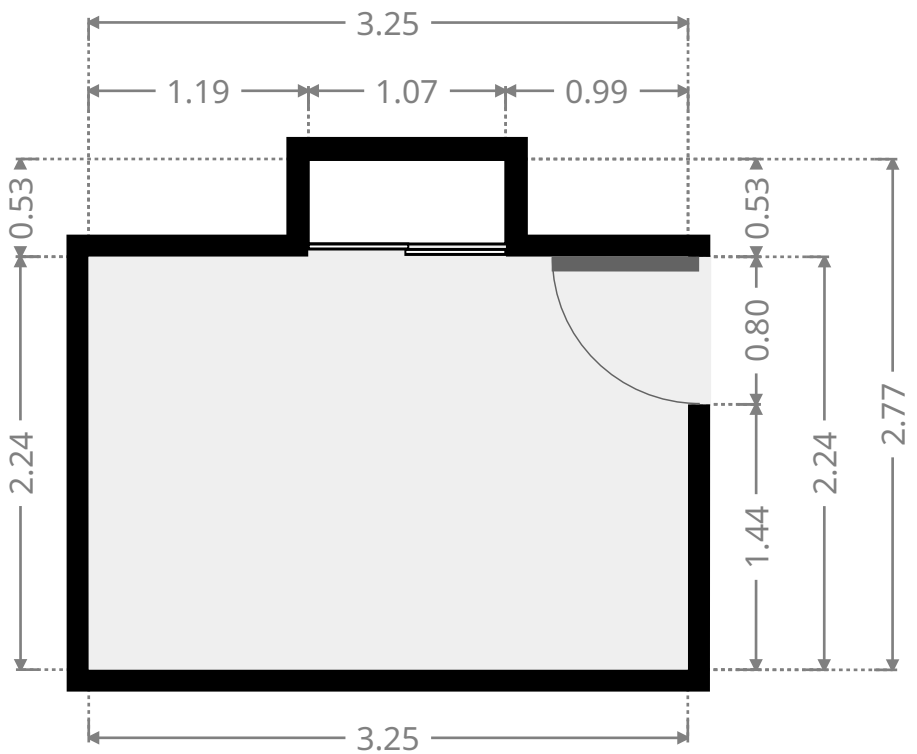
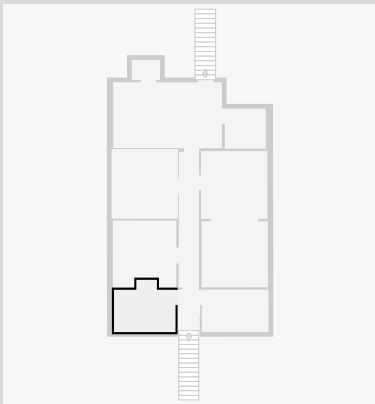

THIS FLOORPLAN IS PROVIDED WITHOUT WARRANTY OF ANY KIND. SENSOPIA DISCLAIMS ANY WARRANTY INCLUDING, WITHOUT LIMITATION, SATISFACTORY QUALITY OR ACCURACY OF DIMENSIONS.

# 342 George Street

## Bedroom

Width: 2.25 m  
Length: 3.54 m  
Area: 7.96 m<sup>2</sup>  
Perimeter: 11.58 m

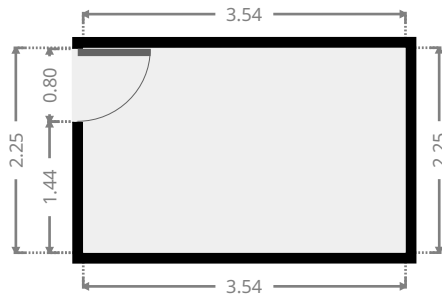
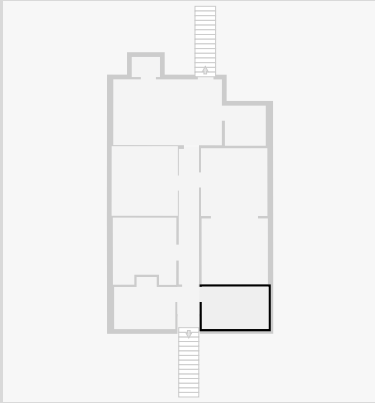

## Hall

Width: 1.08 m  
Length: 7.20 m  
Area: 7.74 m<sup>2</sup>  
Perimeter: 16.55 m

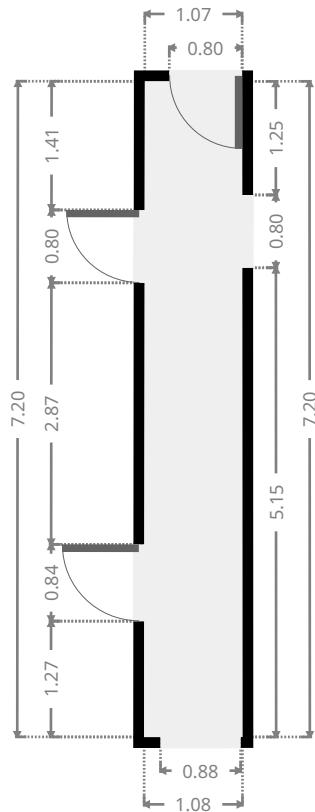
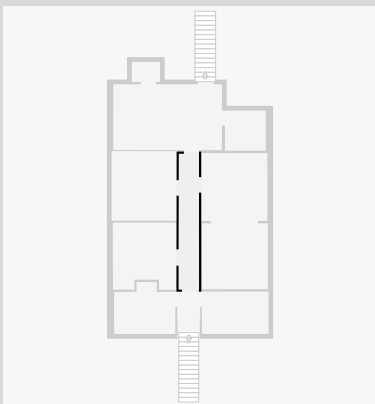

THIS FLOORPLAN IS PROVIDED WITHOUT WARRANTY OF ANY KIND. SENSOPIA DISCLAIMS ANY WARRANTY INCLUDING, WITHOUT LIMITATION, SATISFACTORY QUALITY OR ACCURACY OF DIMENSIONS.

# 342 George Street

## Bedroom

Width: 3.38 m  
Length: 3.57 m  
Area: 11.31 m<sup>2</sup>  
Perimeter: 14.94 m

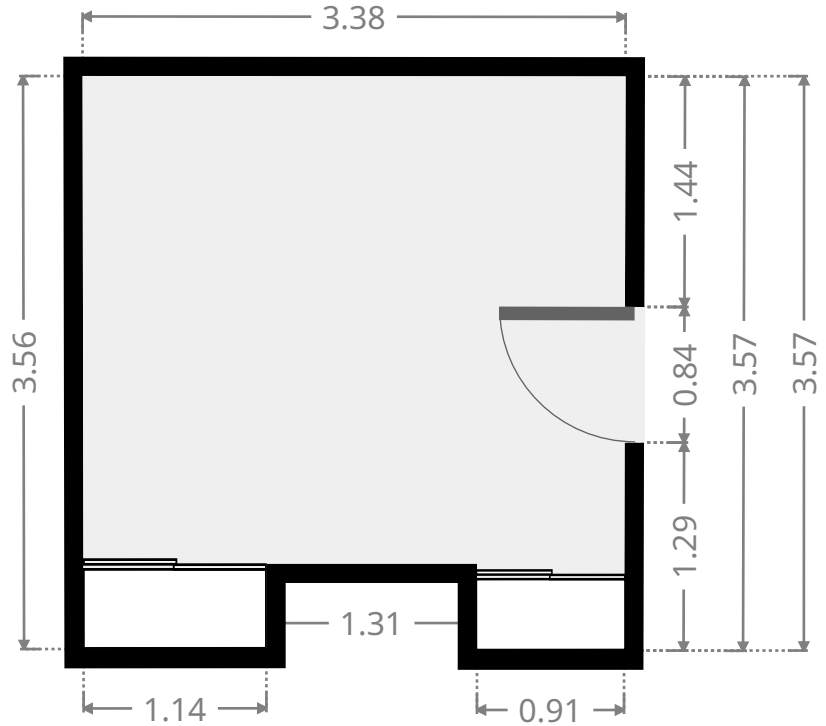
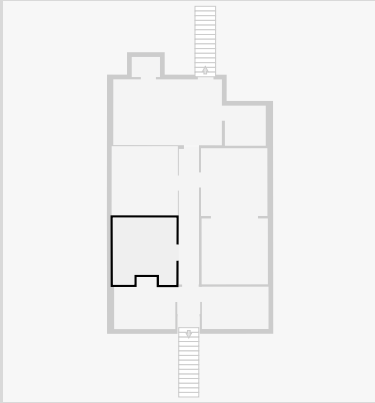

## Living Room

Width: 3.50 m  
Length: 3.52 m  
Area: 12.32 m<sup>2</sup>  
Perimeter: 14.04 m

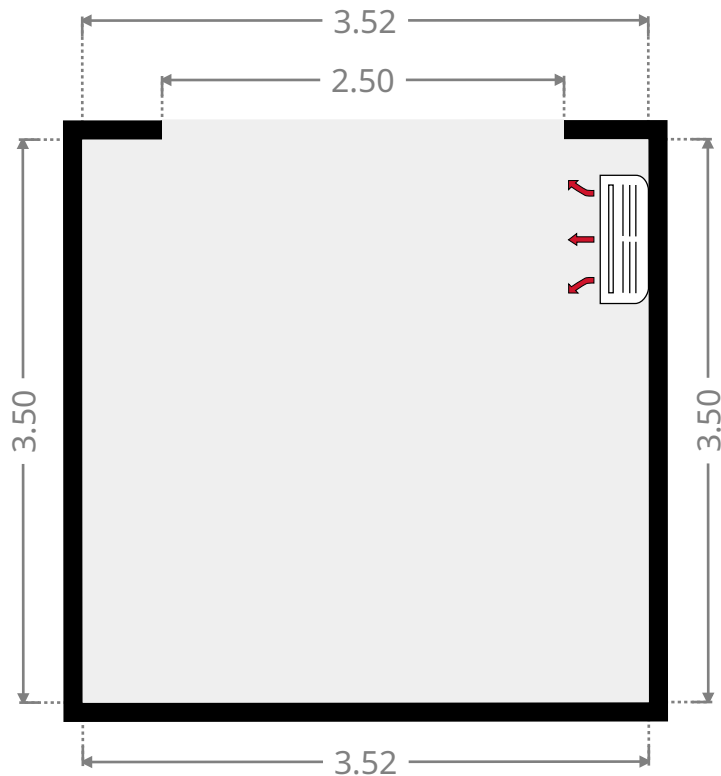
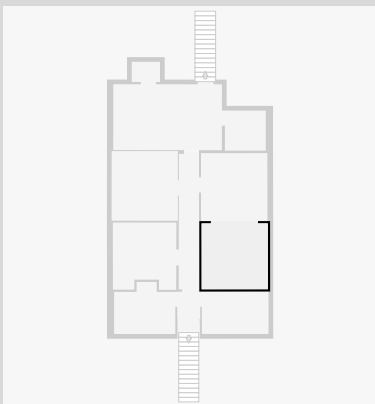

THIS FLOORPLAN IS PROVIDED WITHOUT WARRANTY OF ANY KIND. SENSOPIA DISCLAIMS ANY WARRANTY INCLUDING, WITHOUT LIMITATION, SATISFACTORY QUALITY OR ACCURACY OF DIMENSIONS.

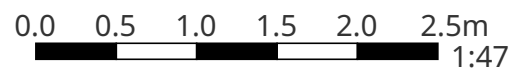



# 342 George Street

## Dining Room

Width: 3.53 m  
 Length: 3.60 m  
 Area: 12.70 m<sup>2</sup>  
 Perimeter: 14.26 m

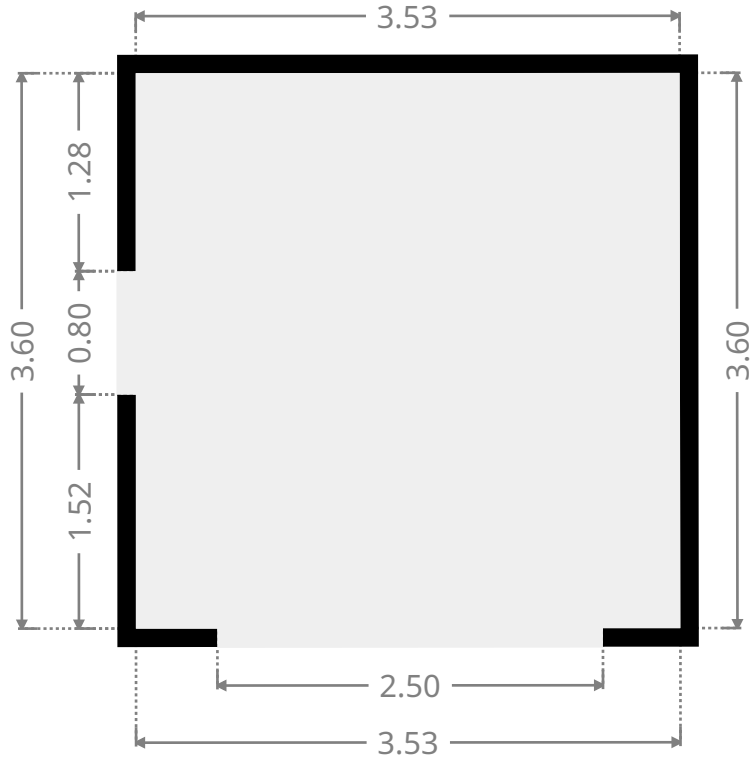
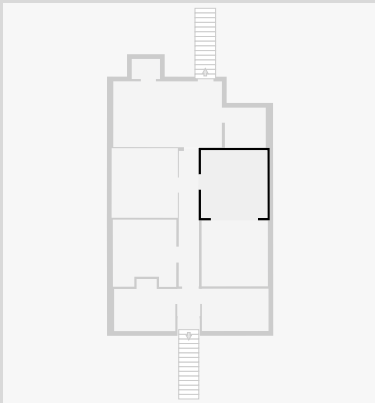

## Bedroom

Width: 3.52 m  
 Length: 3.70 m  
 Area: 13.01 m<sup>2</sup>  
 Perimeter: 14.43 m

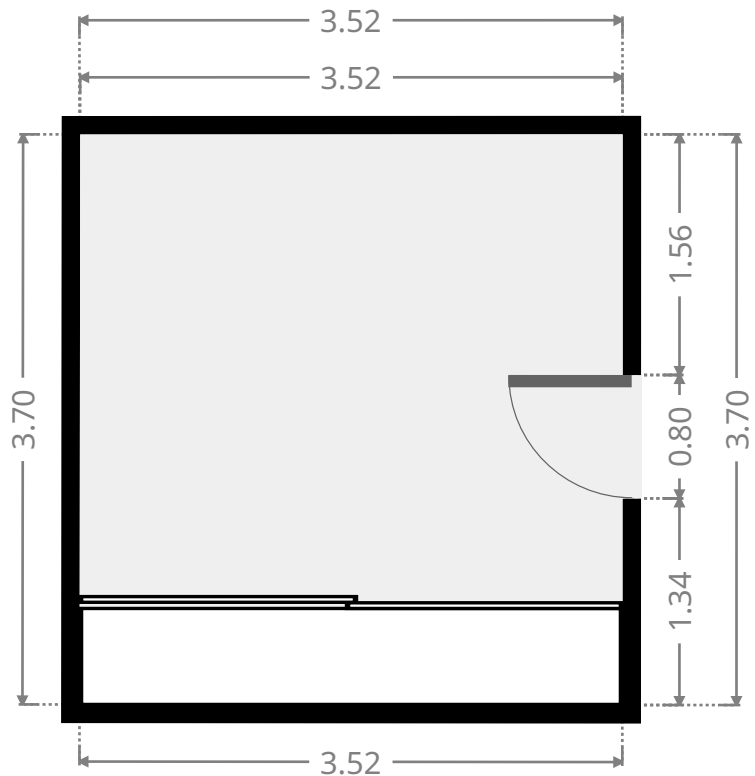
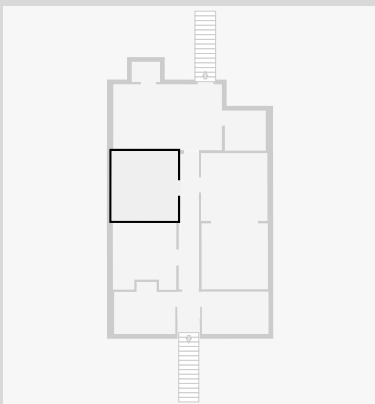

THIS FLOORPLAN IS PROVIDED WITHOUT WARRANTY OF ANY KIND. SENSOPIA DISCLAIMS ANY WARRANTY INCLUDING, WITHOUT LIMITATION, SATISFACTORY QUALITY OR ACCURACY OF DIMENSIONS.

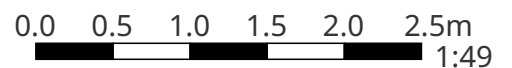

# 342 George Street

## Kitchen

Width: 3.50 m  
 Length: 5.77 m  
 Area: 20.18 m<sup>2</sup>  
 Perimeter: 18.53 m

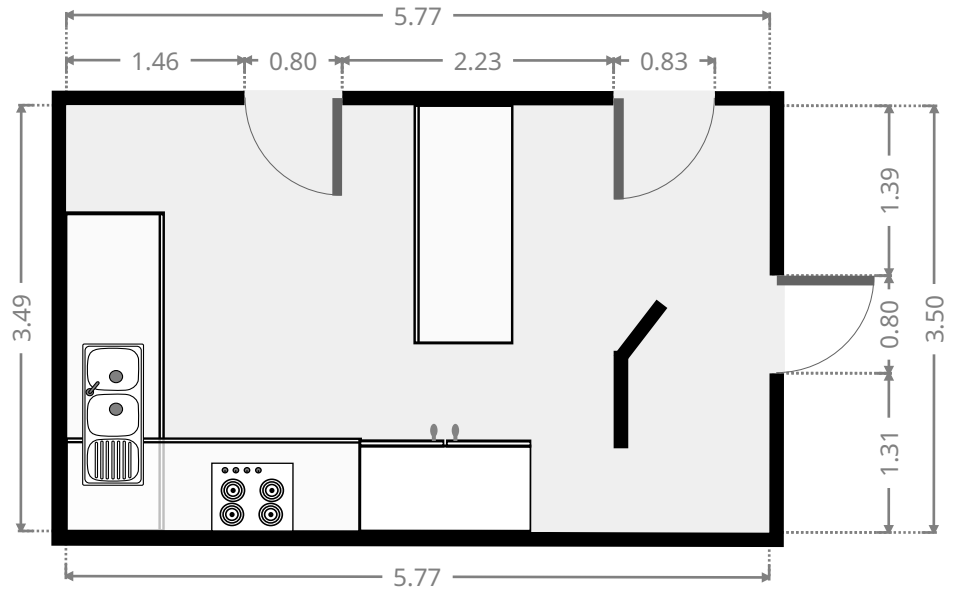
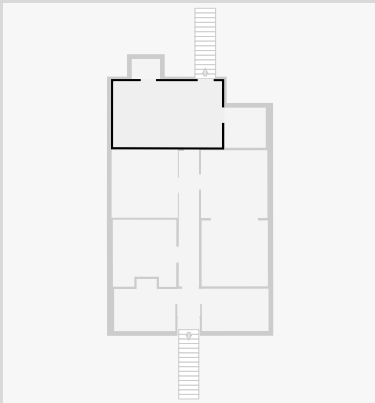

## Other

Width: 1.07 m  
 Length: 1.50 m  
 Area: 1.60 m<sup>2</sup>  
 Perimeter: 5.14 m

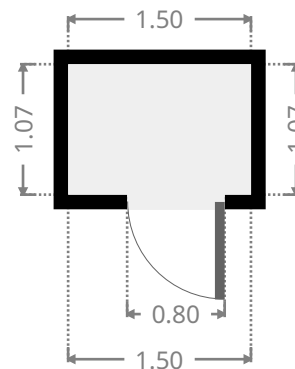
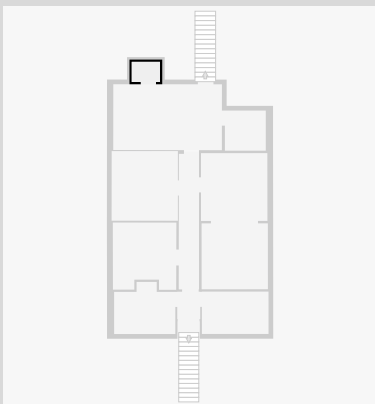

# 342 George Street

## Bathroom

Width: 2.13 m  
Length: 2.17 m  
Area: 4.62 m<sup>2</sup>  
Perimeter: 8.60 m

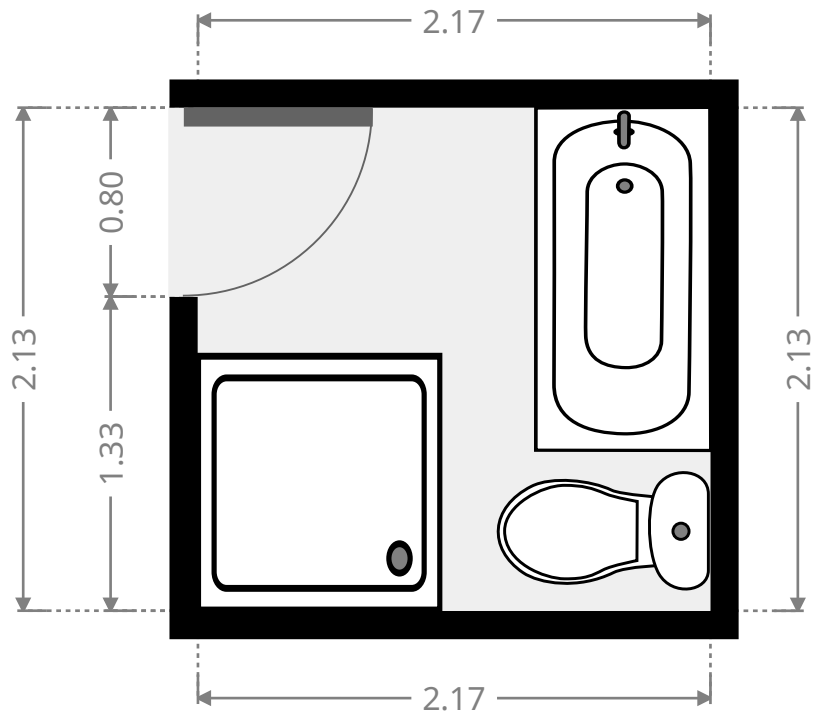
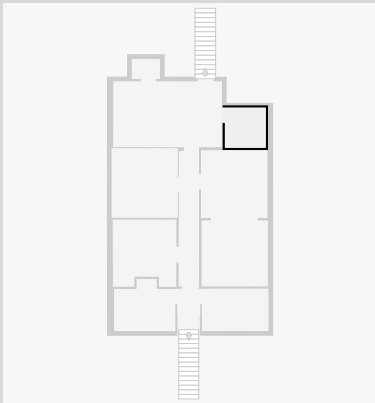

## Other

Width: 0.68 m  
Length: 1.19 m  
Area: 0.80 m<sup>2</sup>  
Perimeter: 3.72 m

