

Ground Floor

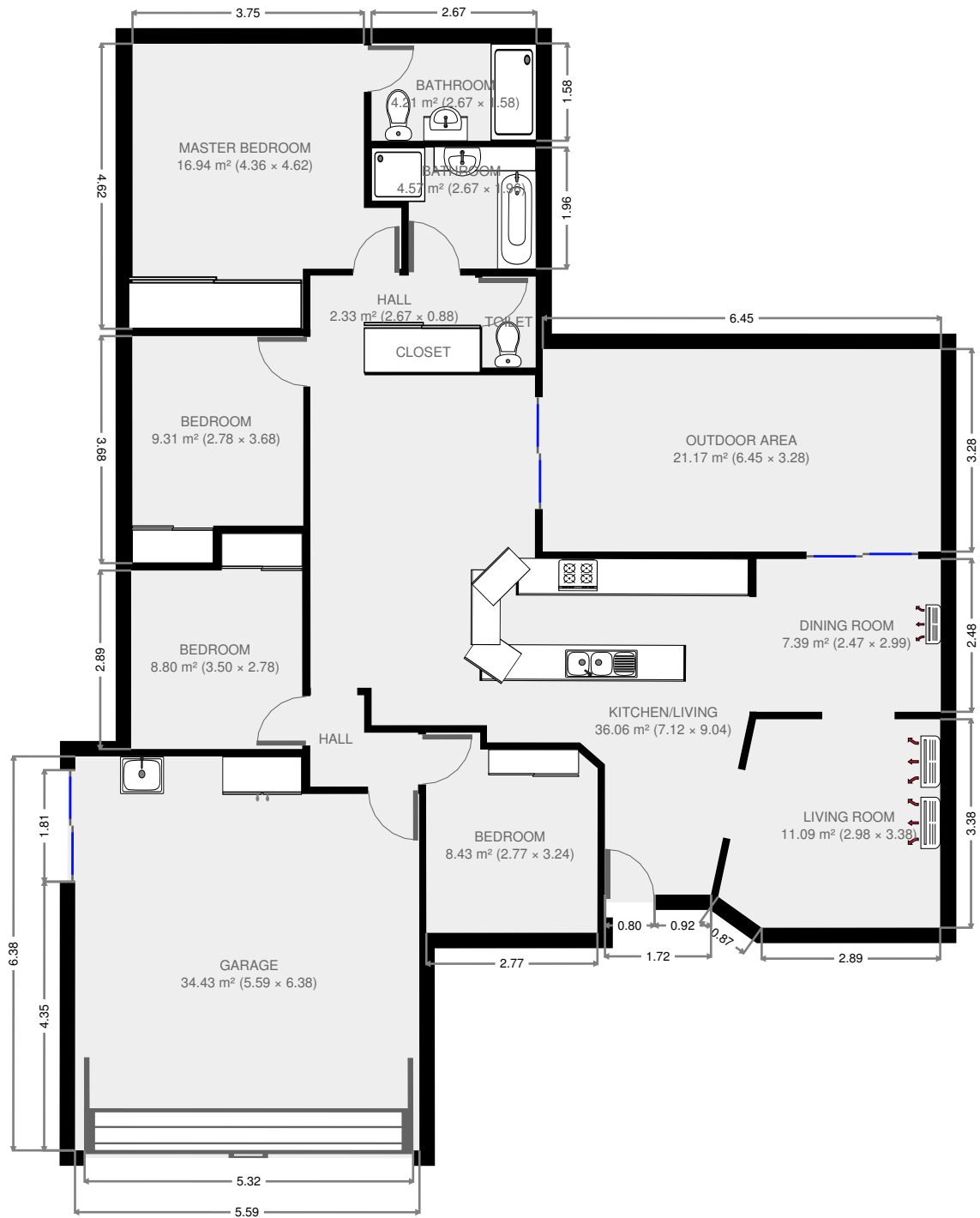

THIS FLOORPLAN IS PROVIDED WITHOUT WARRANTY OF ANY KIND. SENSOPIA DISCLAIMS ANY WARRANTY INCLUDING, WITHOUT LIMITATION, SATISFACTORY QUALITY OR ACCURACY OF DIMENSIONS.

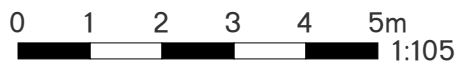

34 Rosewood Drive

Living Room

Width: 2.98 m
 Length: 3.38 m
 Area: 11.09 m²
 Perimeter: 13.06 m
 Ceiling Height: 2.17 m

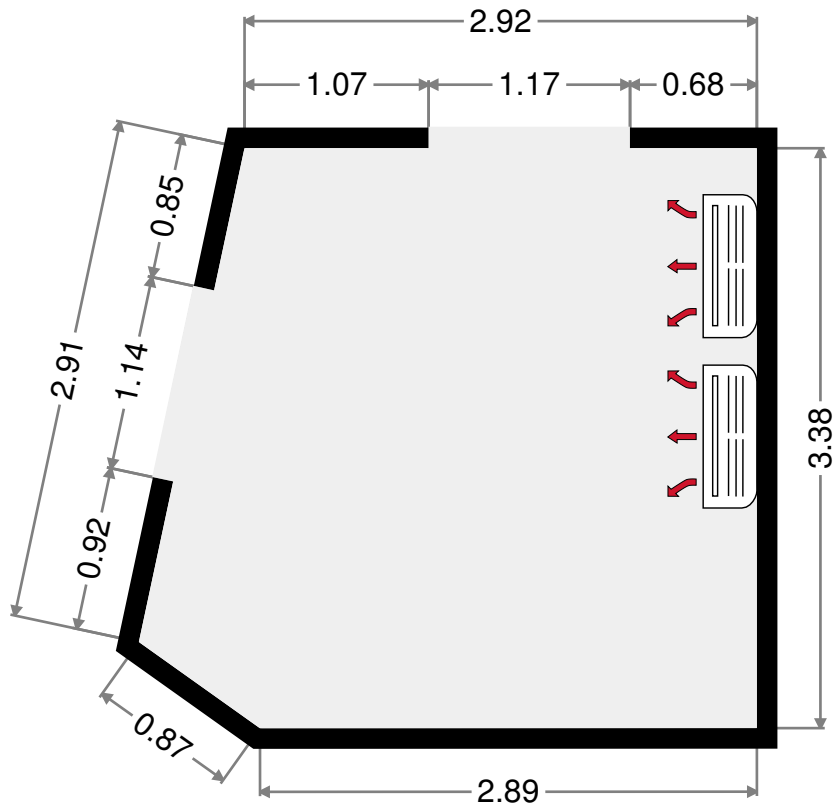
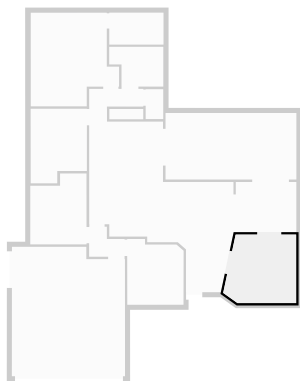

Dining Room

Width: 2.47 m
 Length: 2.99 m
 Area: 7.39 m²
 Perimeter: 10.92 m

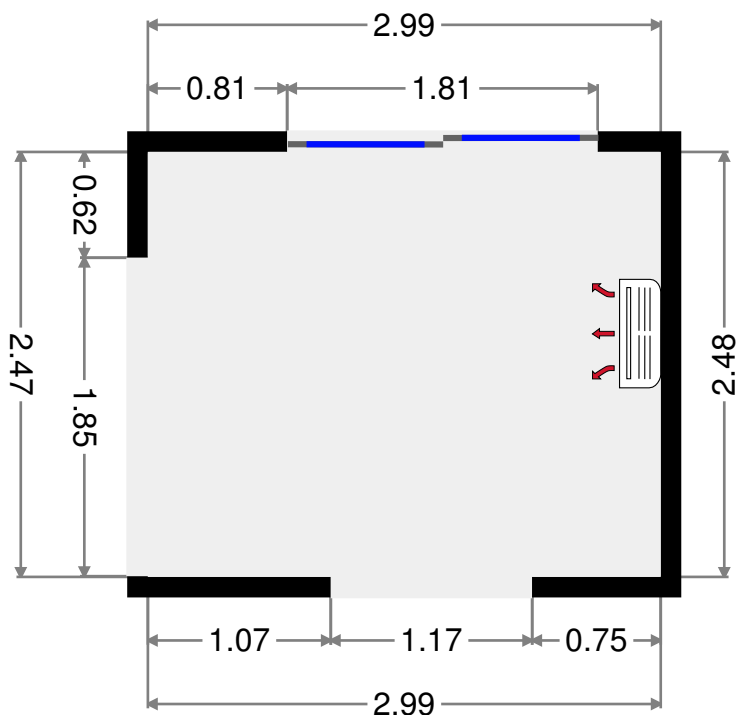
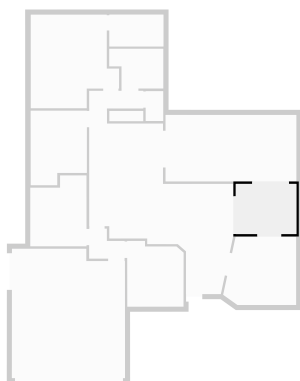

THIS FLOORPLAN IS PROVIDED WITHOUT WARRANTY OF ANY KIND. SENSOPIA DISCLAIMS ANY WARRANTY INCLUDING, WITHOUT LIMITATION, SATISFACTORY QUALITY OR ACCURACY OF DIMENSIONS.

Kitchen/Living

Width: 7.12 m
 Length: 9.04 m
 Area: 36.06 m²
 Perimeter: 31.53 m
 Ceiling Height: 2.17 m

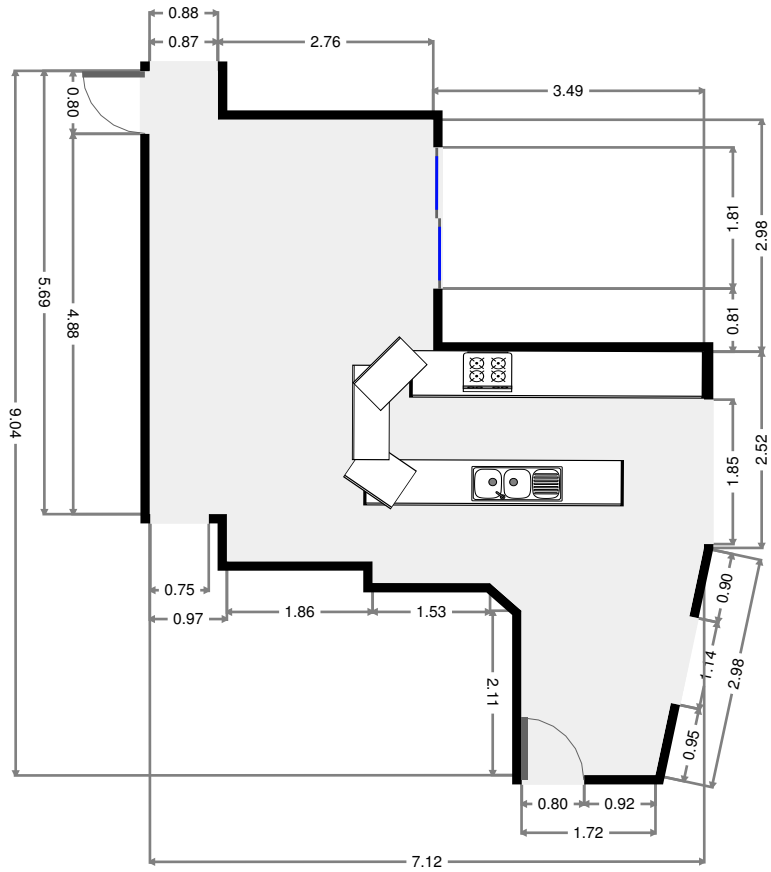
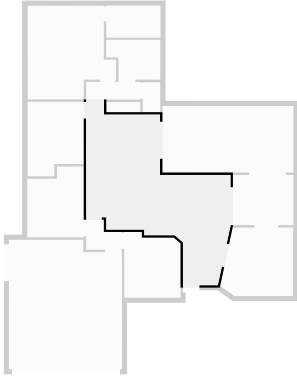

Hall

Width: 1.48 m
 Length: 1.74 m
 Area: 2.05 m²
 Perimeter: 6.45 m

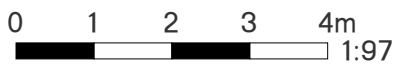
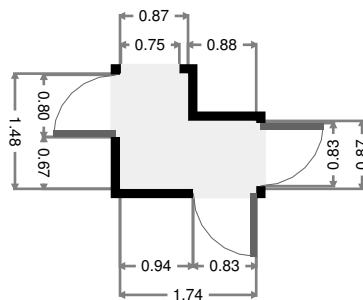
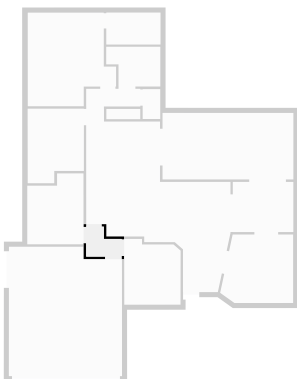

THIS FLOORPLAN IS PROVIDED WITHOUT WARRANTY OF ANY KIND. SENSOPIA DISCLAIMS ANY WARRANTY INCLUDING, WITHOUT LIMITATION, SATISFACTORY QUALITY OR ACCURACY OF DIMENSIONS.

Bedroom

Width: 2.77 m
 Length: 3.24 m
 Area: 8.43 m²
 Perimeter: 11.85 m

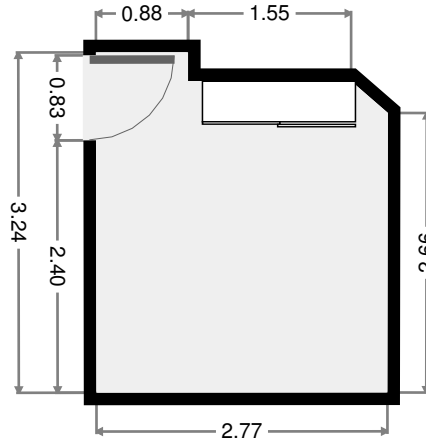
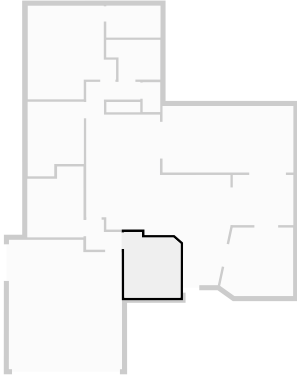

Garage

Width: 5.59 m
 Length: 6.38 m
 Area: 34.43 m²
 Perimeter: 23.92 m

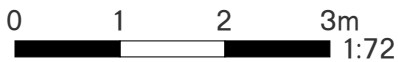
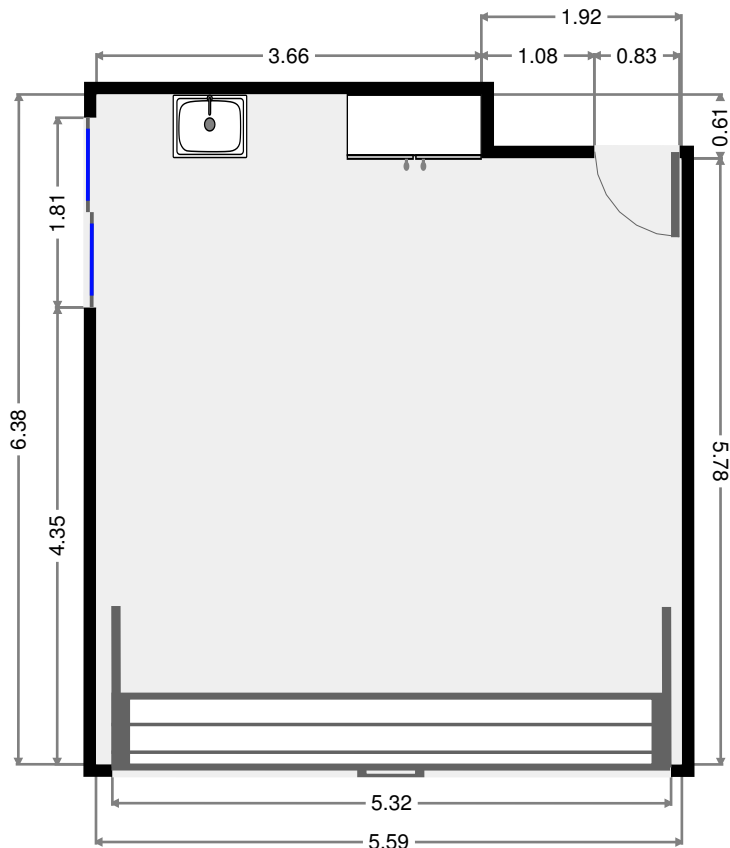
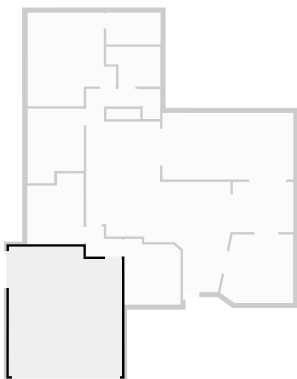

THIS FLOORPLAN IS PROVIDED WITHOUT WARRANTY OF ANY KIND. SENSOPIA DISCLAIMS ANY WARRANTY INCLUDING, WITHOUT LIMITATION, SATISFACTORY QUALITY OR ACCURACY OF DIMENSIONS.

Bedroom

Width: 2.78 m
 Length: 3.50 m
 Area: 8.80 m²
 Perimeter: 12.53 m

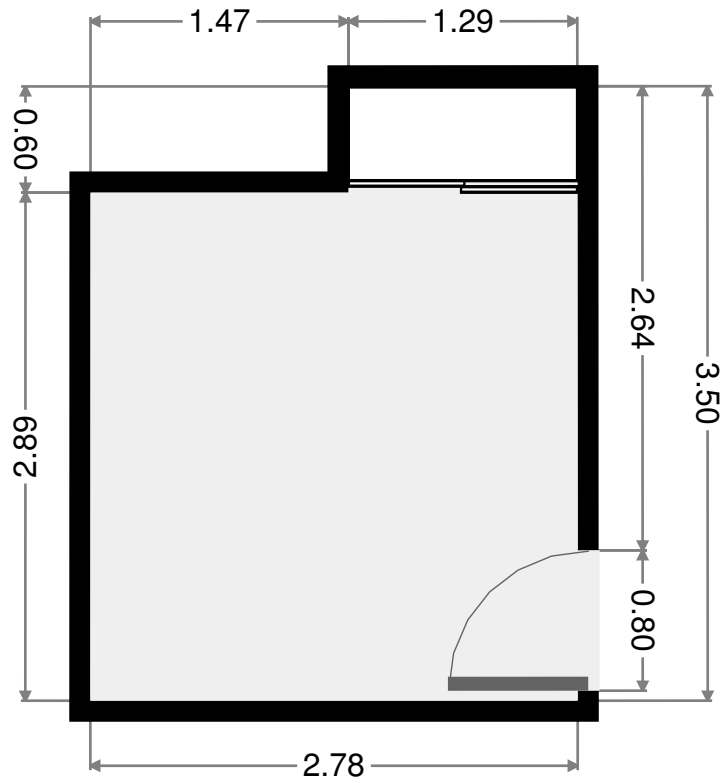
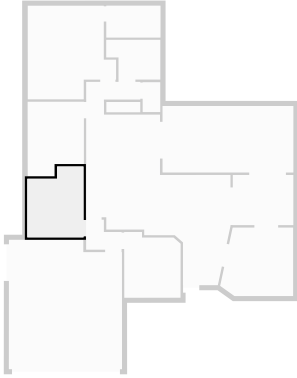

Bedroom

Width: 2.78 m
 Length: 3.68 m
 Area: 9.31 m²
 Perimeter: 12.90 m

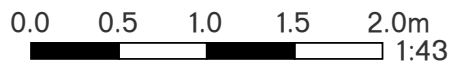
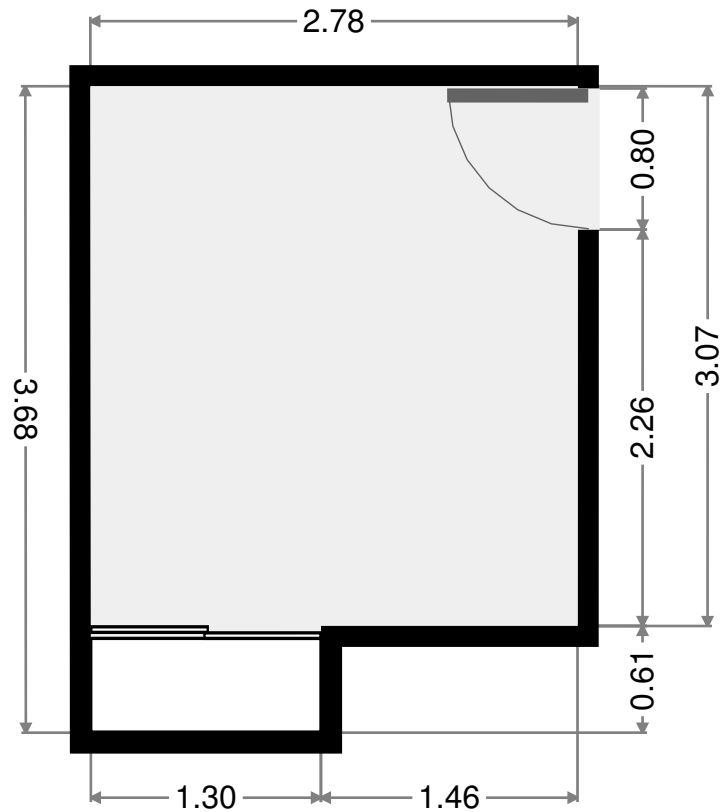
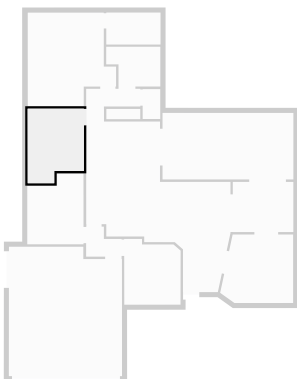

THIS FLOORPLAN IS PROVIDED WITHOUT WARRANTY OF ANY KIND. SENSOPIA DISCLAIMS ANY WARRANTY INCLUDING, WITHOUT LIMITATION, SATISFACTORY QUALITY OR ACCURACY OF DIMENSIONS.

Hall

Width: 0.88 m
 Length: 2.67 m
 Area: 2.33 m²
 Perimeter: 7.08 m

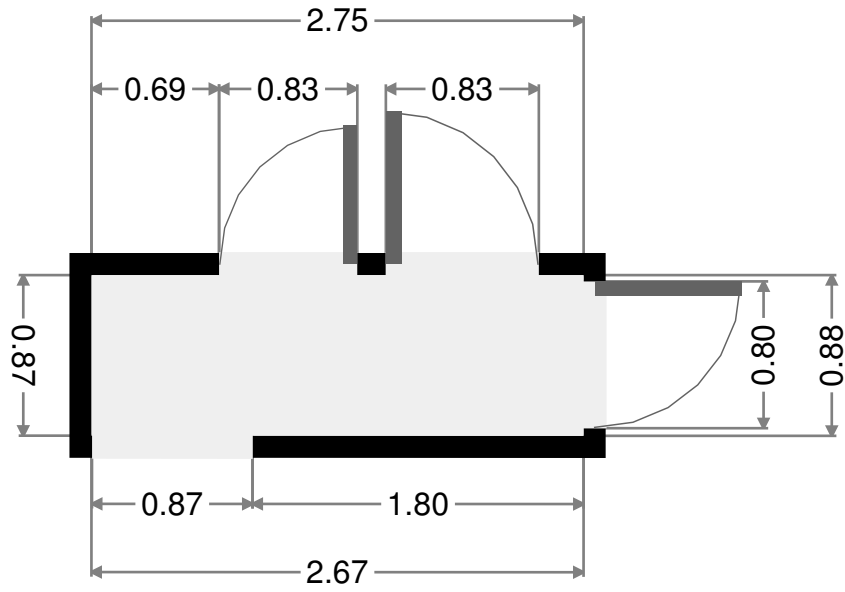
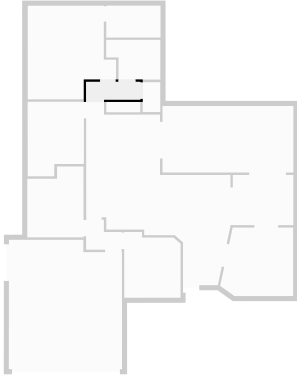

Toilet

Width: 0.87 m
 Length: 1.47 m
 Area: 1.27 m²
 Perimeter: 4.68 m

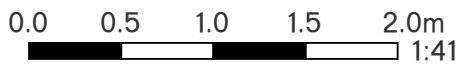
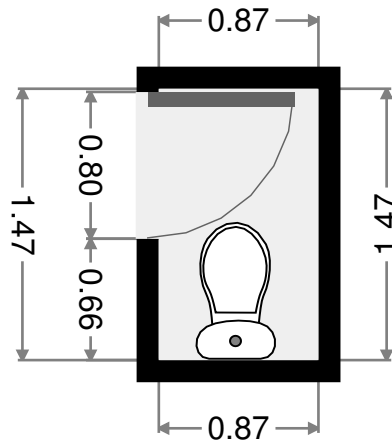
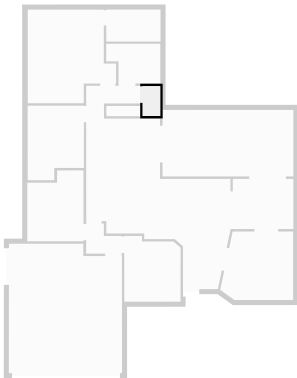

THIS FLOORPLAN IS PROVIDED WITHOUT WARRANTY OF ANY KIND. SENSOPIA DISCLAIMS ANY WARRANTY INCLUDING, WITHOUT LIMITATION, SATISFACTORY QUALITY OR ACCURACY OF DIMENSIONS.

Closet

Width: 0.51 m
Length: 1.67 m
Area: 0.85 m²
Perimeter: 4.36 m

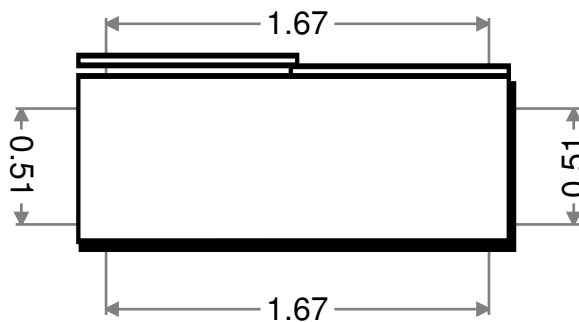
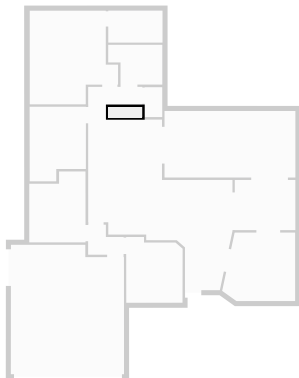

Bathroom

Width: 1.96 m
Length: 2.67 m
Area: 4.57 m²
Perimeter: 9.26 m

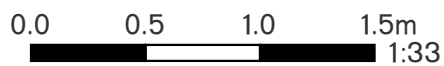
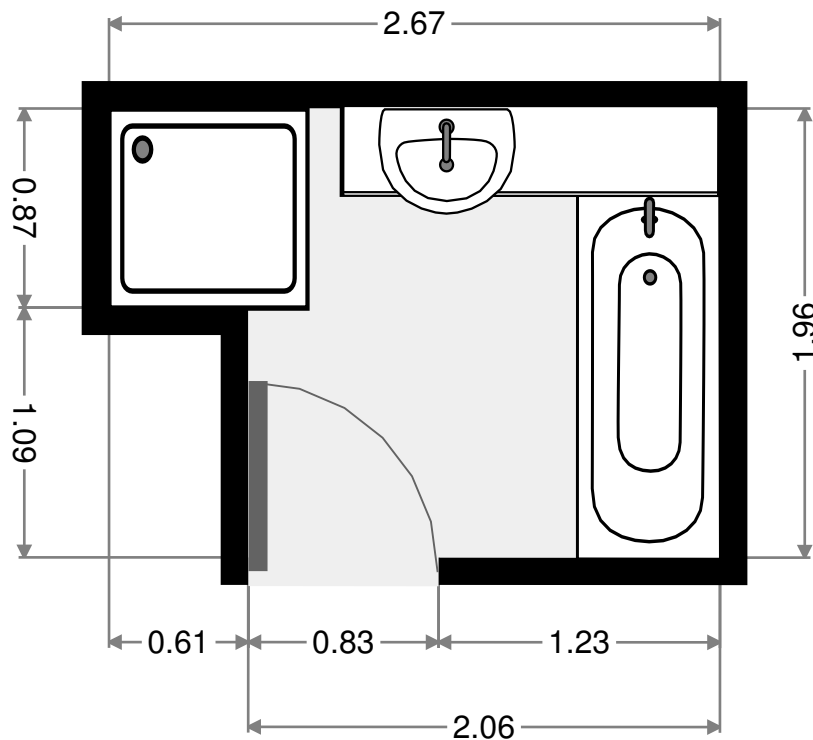
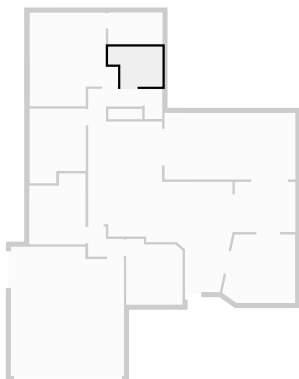

THIS FLOORPLAN IS PROVIDED WITHOUT WARRANTY OF ANY KIND. SENSOPIA DISCLAIMS ANY WARRANTY INCLUDING, WITHOUT LIMITATION, SATISFACTORY QUALITY OR ACCURACY OF DIMENSIONS.

Master Bedroom

Width: 4.36 m
 Length: 4.62 m
 Area: 16.94 m²
 Perimeter: 17.95 m

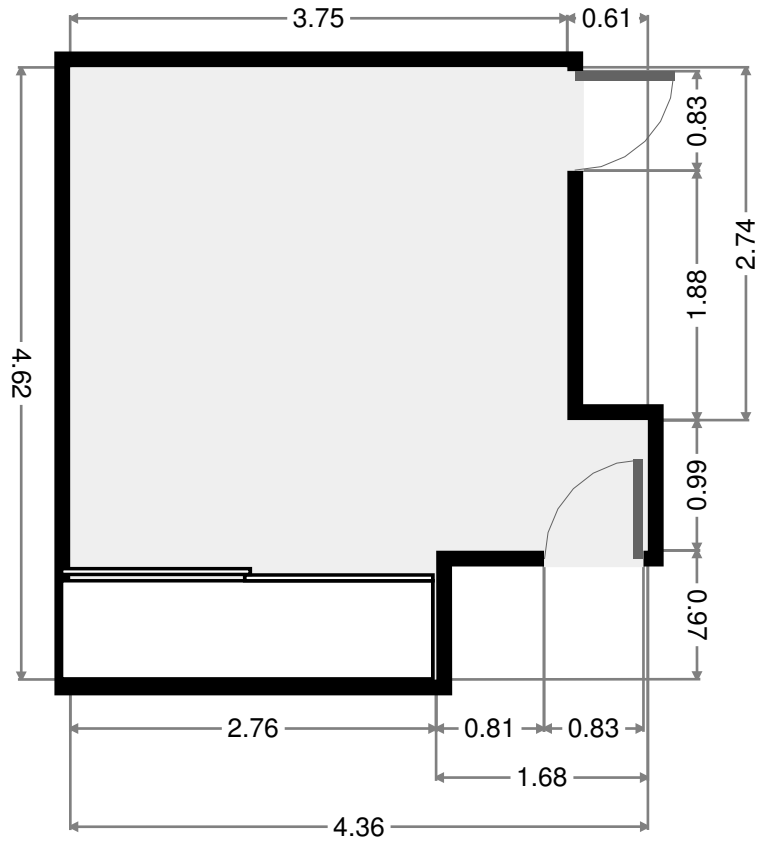
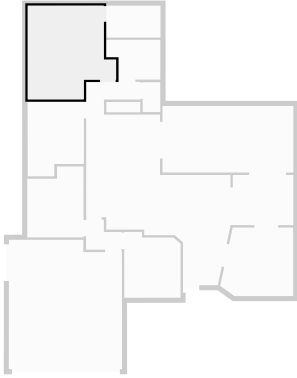

Bathroom

Width: 1.58 m
 Length: 2.67 m
 Area: 4.21 m²
 Perimeter: 8.50 m

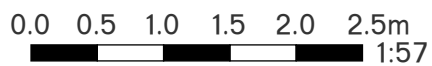
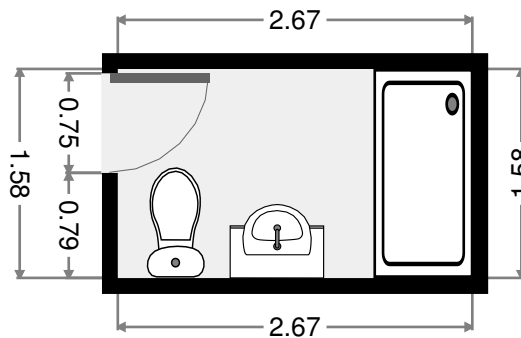
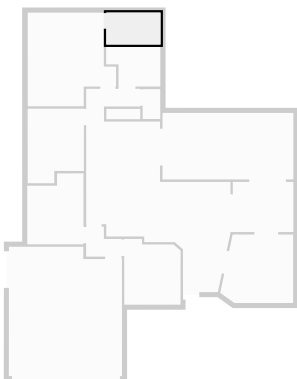

THIS FLOORPLAN IS PROVIDED WITHOUT WARRANTY OF ANY KIND. SENSOPIA DISCLAIMS ANY WARRANTY INCLUDING, WITHOUT LIMITATION, SATISFACTORY QUALITY OR ACCURACY OF DIMENSIONS.

Outdoor Area

Width: 3.28 m
Length: 6.45 m
Area: 21.17 m²
Perimeter: 19.47 m

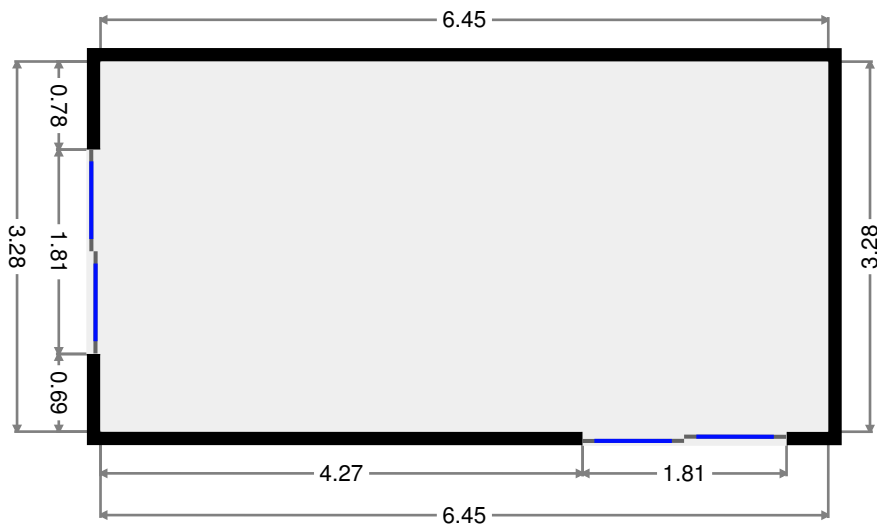
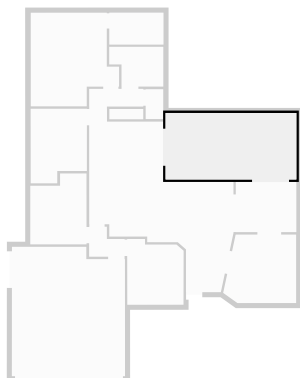

THIS FLOORPLAN IS PROVIDED WITHOUT WARRANTY OF ANY KIND. SENSOPIA DISCLAIMS ANY WARRANTY INCLUDING, WITHOUT LIMITATION, SATISFACTORY QUALITY OR ACCURACY OF DIMENSIONS.

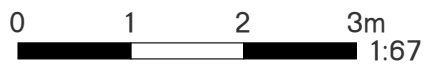

34 Rosewood Drive

2017-04-06