

# 34 Millers Place

**SUBMITTED BY**  
Ray White Rockhampton Casey  
stockers@cqoz.com

---

**CREATED ON**  
2022-11-24

---

**Floors**  
1

---

## ▼ Ground Floor

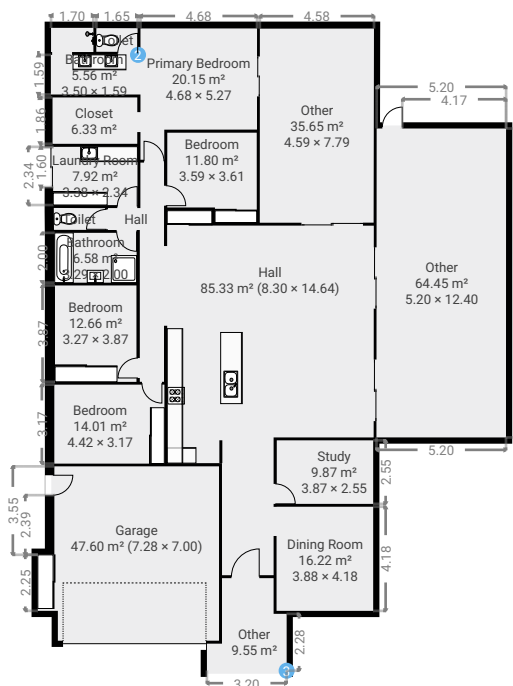
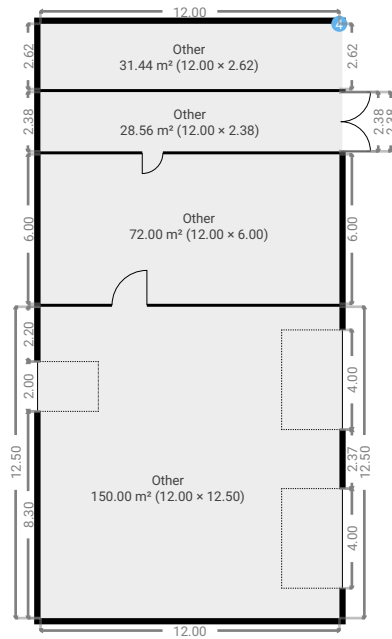

FLOORS: 1

▼ **Bathroom**  
Ground Floor

WIDTH: 3.29 m • LENGTH: 2.00 m  
AREA: 6.58 m<sup>2</sup> • PERIMETER: 10.58 m

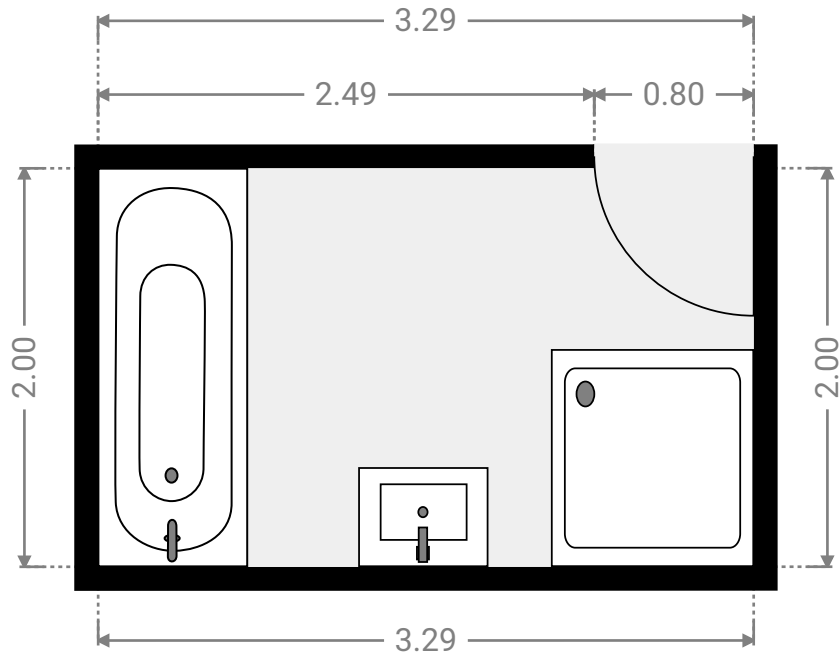

▼ **Bathroom**  
Ground Floor

WIDTH: 3.50 m • LENGTH: 1.59 m  
AREA: 5.56 m<sup>2</sup> • PERIMETER: 10.18 m

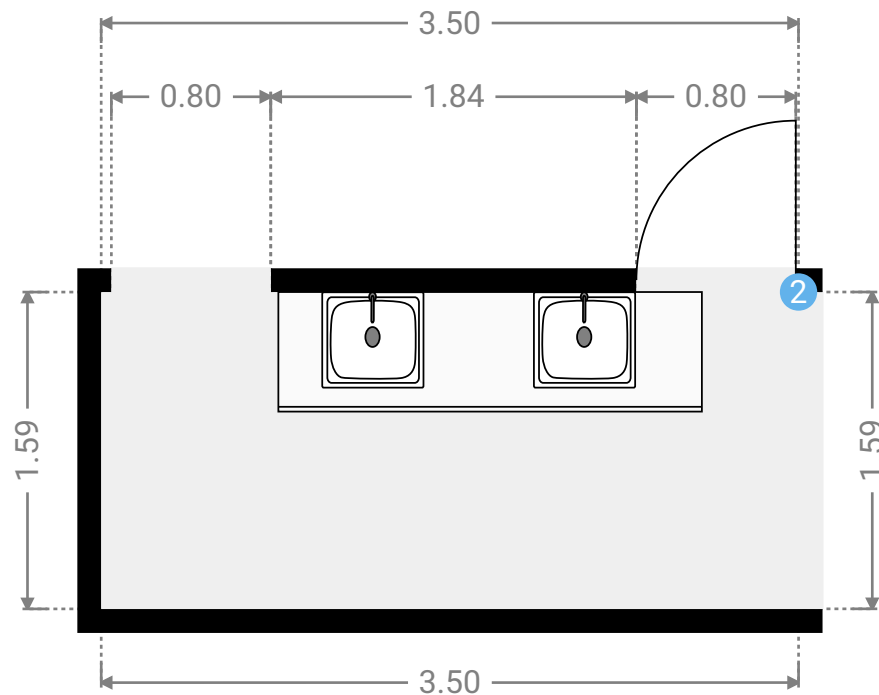

## ▼ Bathroom/Ground Floor

### 2 OPENING

Height  
0.00 m



FLOORS: 1

## ▼ Bathroom Ground Floor

WIDTH: 1.70 m • LENGTH: 0.97 m  
AREA: 1.65 m<sup>2</sup> • PERIMETER: 5.34 m

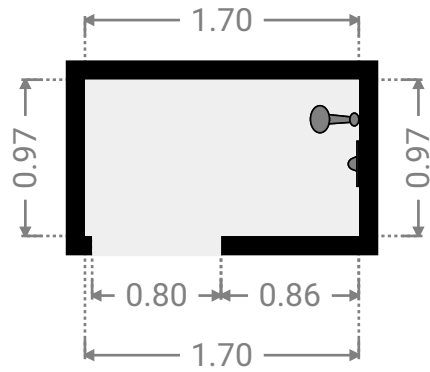

## ▼ Bedroom Ground Floor

WIDTH: 4.42 m • LENGTH: 3.17 m  
AREA: 14.01 m<sup>2</sup> • PERIMETER: 15.18 m

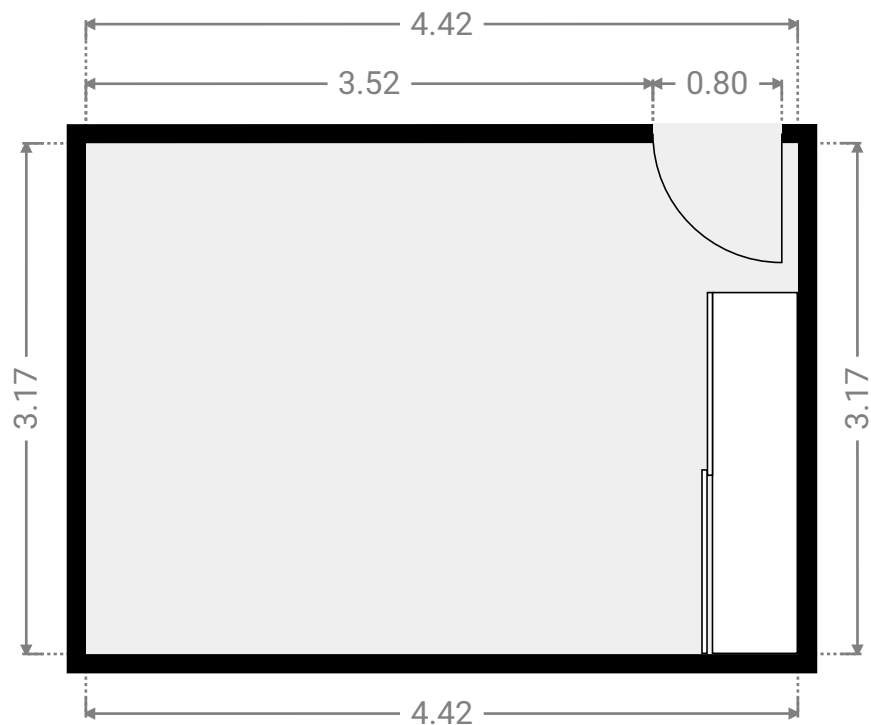
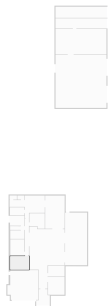

▼ **Bedroom**  
Ground Floor

WIDTH: 3.27 m • LENGTH: 3.87 m  
AREA: 12.66 m<sup>2</sup> • PERIMETER: 14.28 m

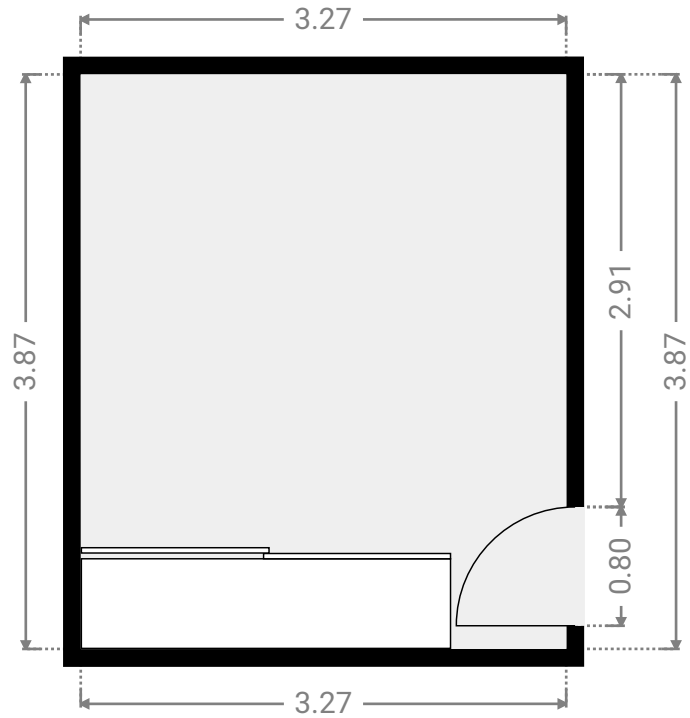

▼ **Bedroom**  
Ground Floor

WIDTH: 3.59 m • LENGTH: 3.61 m  
AREA: 11.80 m<sup>2</sup> • PERIMETER: 14.40 m

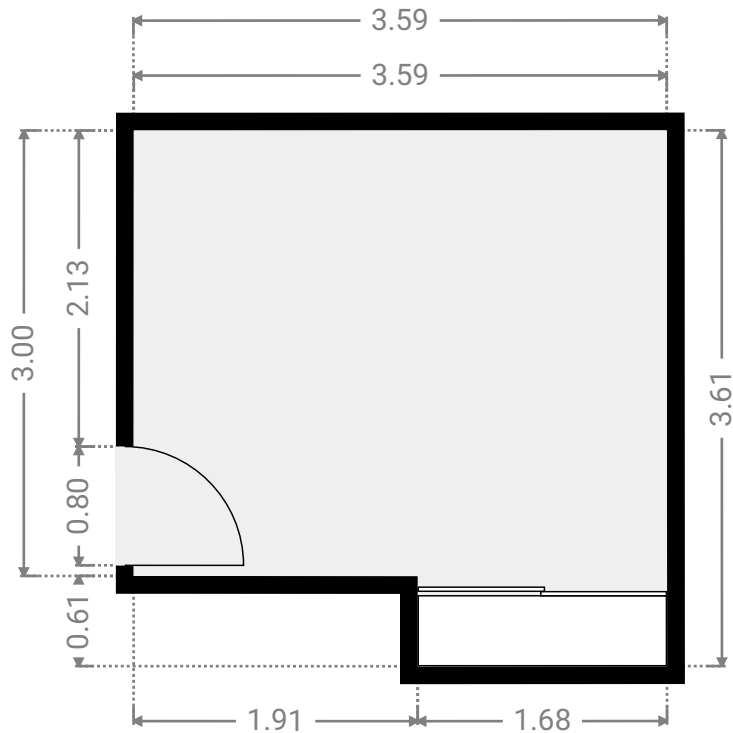

## ▼ Dining Room Ground Floor

WIDTH: 3.88 m • LENGTH: 4.18 m  
AREA: 16.22 m<sup>2</sup> • PERIMETER: 16.12 m

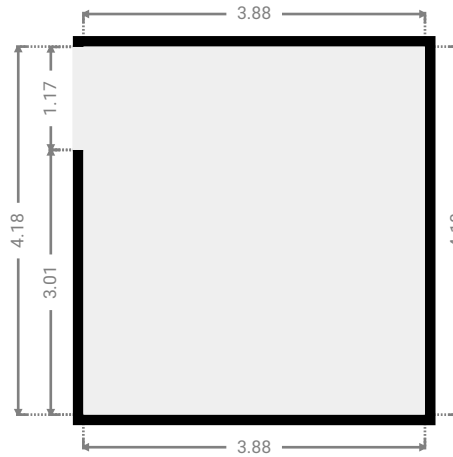

## ▼ Garage Ground Floor

WIDTH: 7.28 m • LENGTH: 7.00 m  
AREA: 47.60 m<sup>2</sup> • PERIMETER: 28.55 m

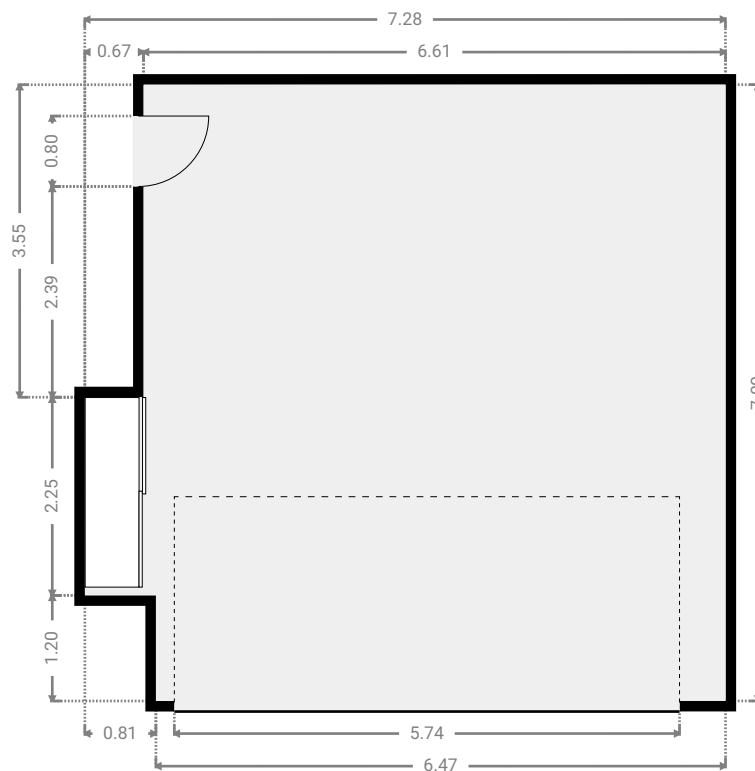

▼ Hall  
Ground Floor

WIDTH: 8.30 m • LENGTH: 14.64 m  
AREA: 85.33 m<sup>2</sup> • PERIMETER: 45.85 m

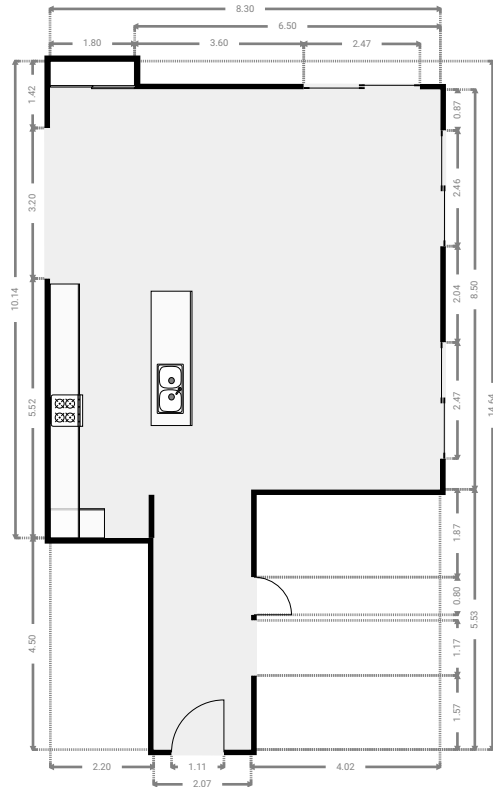

▼ Hall  
Ground Floor

WIDTH: 2.25 m • LENGTH: 8.80 m  
AREA: 9.63 m<sup>2</sup> • PERIMETER: 22.10 m

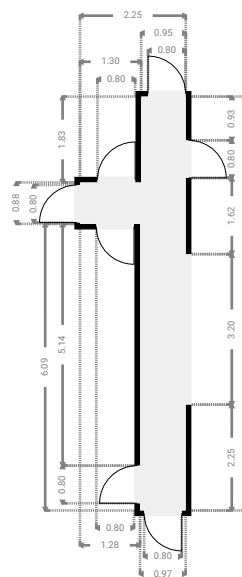



## ▼ Laundry Room Ground Floor

WIDTH: 3.38 m • LENGTH: 2.34 m  
AREA: 7.92 m<sup>2</sup> • PERIMETER: 11.45 m

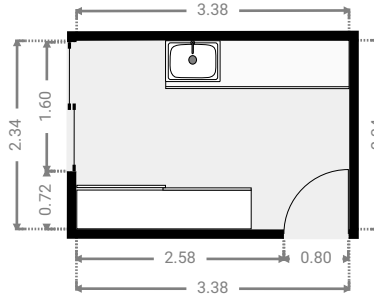
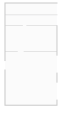

## ▼ Other Ground Floor

WIDTH: 4.59 m • LENGTH: 7.79 m  
AREA: 35.65 m<sup>2</sup> • PERIMETER: 24.73 m

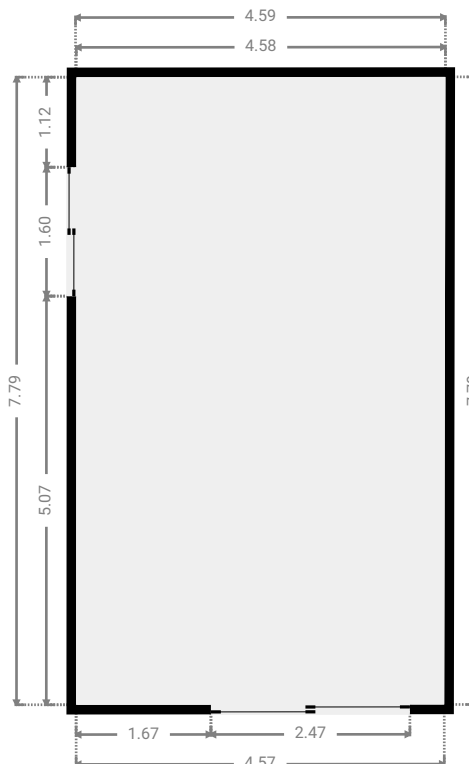

FLOORS: 1

## ▼ Other Ground Floor

WIDTH: 5.20 m • LENGTH: 12.40 m  
AREA: 64.45 m<sup>2</sup> • PERIMETER: 35.20 m

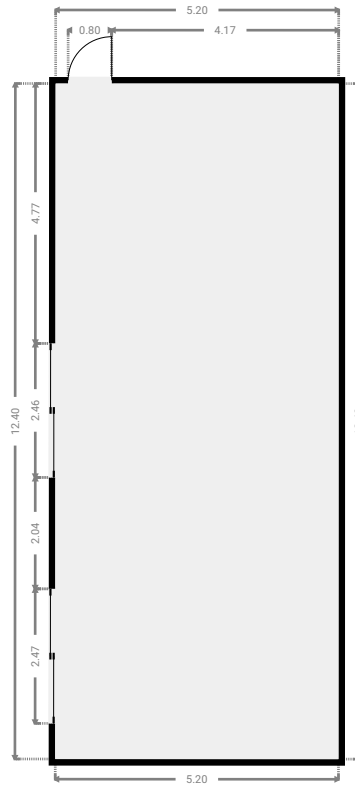

## ▼ Other Ground Floor

WIDTH: 3.20 m • LENGTH: 3.72 m  
AREA: 9.55 m<sup>2</sup> • PERIMETER: 13.83 m

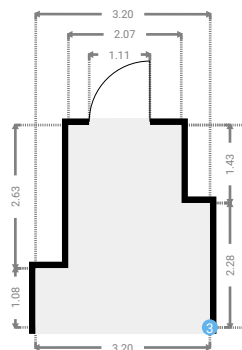

## ▼ Other/Ground Floor

### 3 OPENING

Height  
0.00 m



## ▼ Other Ground Floor

WIDTH: 12.00 m • LENGTH: 12.50 m  
AREA: 150.00 m<sup>2</sup> • PERIMETER: 49.00 m

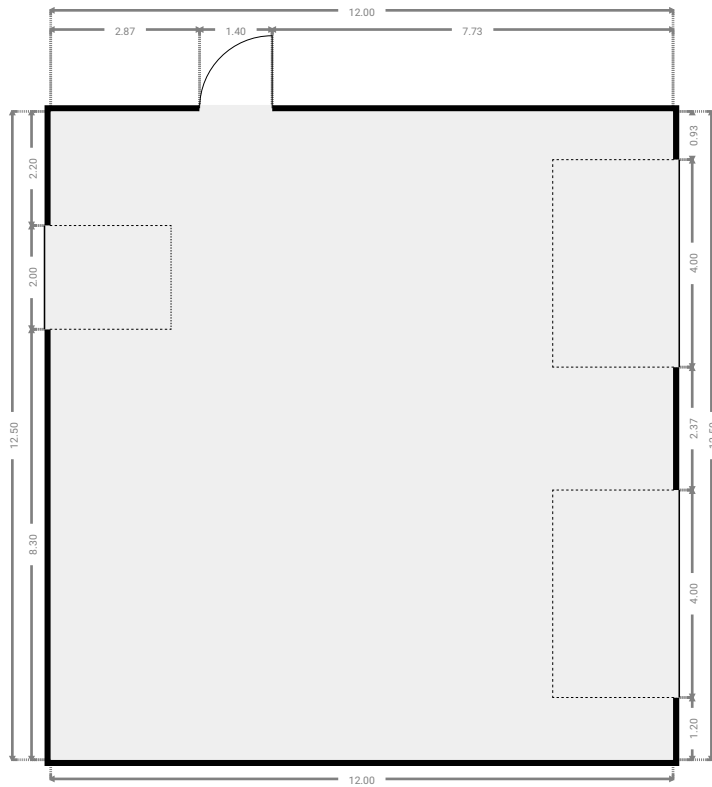

## ▼ Other Ground Floor

WIDTH: 12.00 m • LENGTH: 6.00 m  
AREA: 72.00 m<sup>2</sup> • PERIMETER: 36.00 m

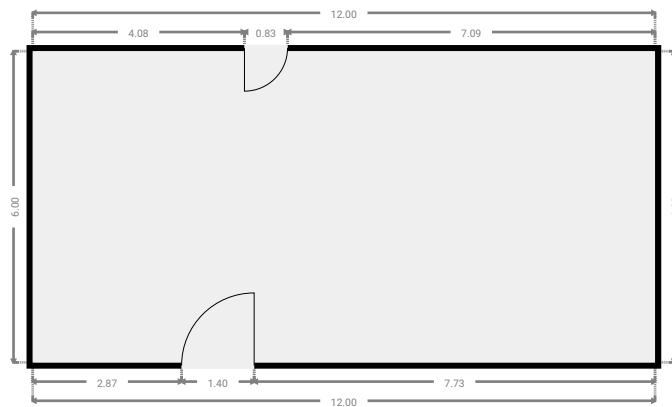

# 34 Millers Place

FLOORS: 1



## ▼ Other Ground Floor

WIDTH: 12.00 m • LENGTH: 2.38 m  
AREA: 28.56 m<sup>2</sup> • PERIMETER: 28.76 m

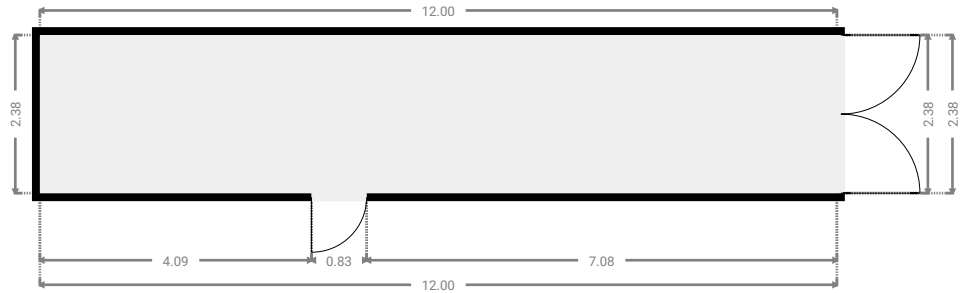
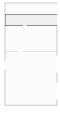

## ▼ Other Ground Floor

WIDTH: 12.00 m • LENGTH: 2.62 m  
AREA: 31.44 m<sup>2</sup> • PERIMETER: 29.24 m

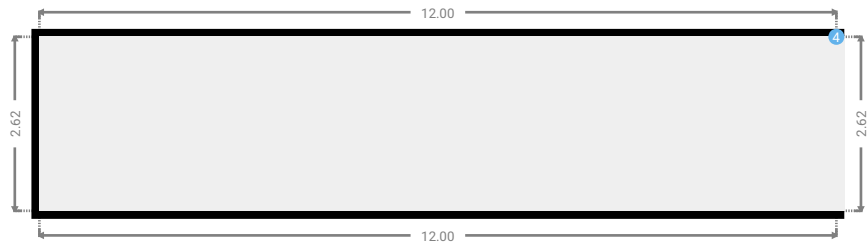

## ▼ Other/Ground Floor

### 4 OPENING

Height  
0.00 m



## ▼ Primary Bedroom Ground Floor

WIDTH: 4.68 m • LENGTH: 5.27 m  
AREA: 20.15 m<sup>2</sup> • PERIMETER: 19.89 m

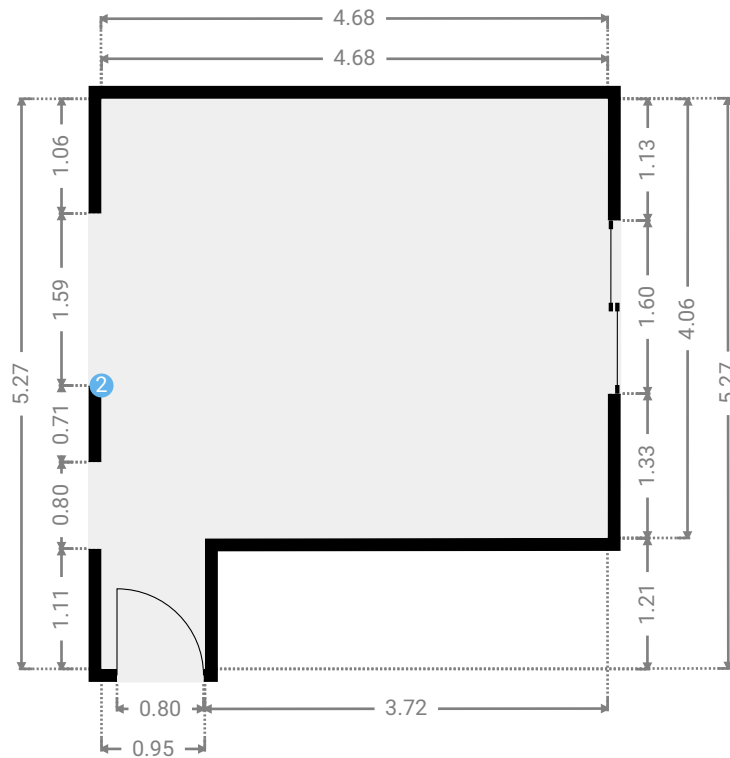

## ▼ Closet Ground Floor

WIDTH: 3.40 m • LENGTH: 1.86 m  
AREA: 6.33 m<sup>2</sup> • PERIMETER: 10.52 m

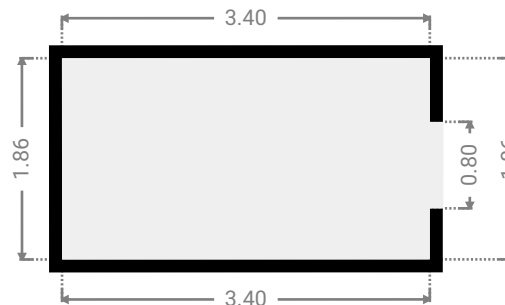

## ▼ Study Ground Floor

WIDTH: 3.87 m • LENGTH: 2.55 m  
AREA: 9.87 m<sup>2</sup> • PERIMETER: 12.84 m

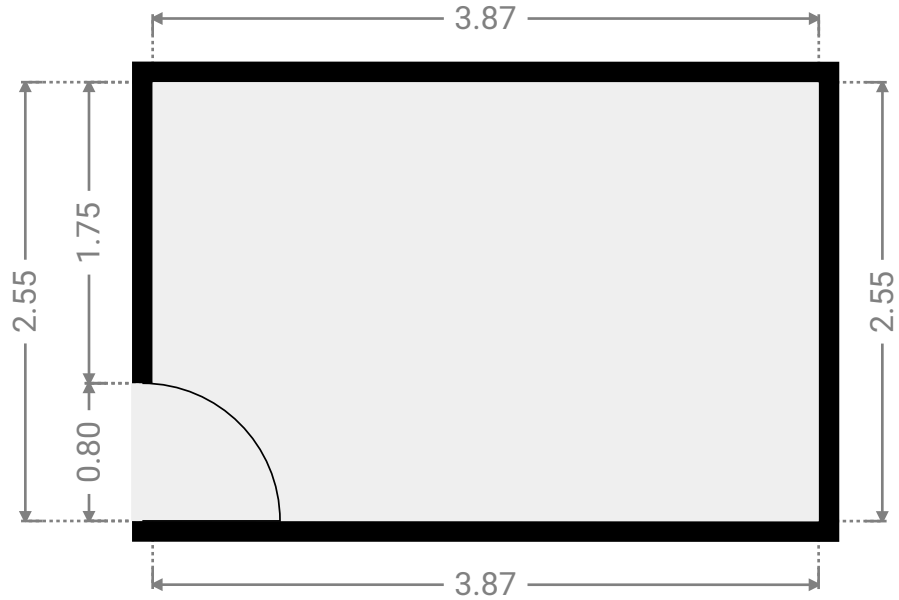

## ▼ Toilet Ground Floor

WIDTH: 2.06 m • LENGTH: 0.88 m  
AREA: 1.80 m<sup>2</sup> • PERIMETER: 5.86 m

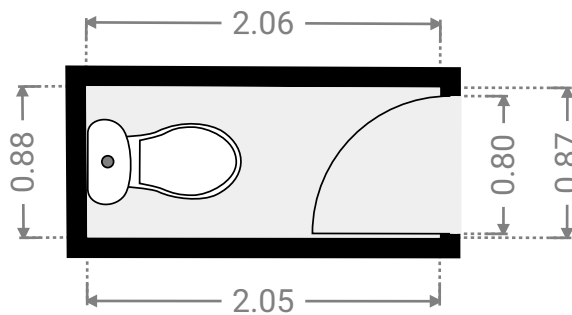



▼ Toilet  
Ground Floor

WIDTH: 1.66 m • LENGTH: 0.96 m  
AREA: 1.57 m<sup>2</sup> • PERIMETER: 5.21 m

