

33 StringyBark Avenue

SUBMITTED BY
Janelle Casey

CREATED ON
2021-10-19

<p>Floors 1</p>

FLOORS: 1

▼ Ground Floor

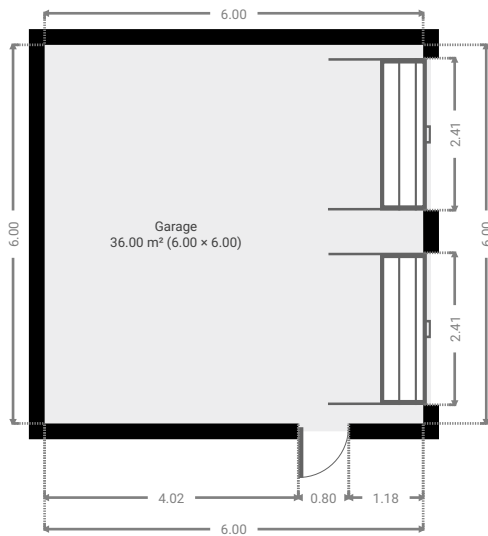

THIS FLOORPLAN IS PROVIDED WITHOUT WARRANTY OF ANY KIND. SENSOPIA DISCLAIMS ANY WARRANTY INCLUDING, WITHOUT LIMITATION, SATISFACTORY QUALITY OR ACCURACY OF DIMENSIONS.

FLOORS: 1

▼ Living Room
Ground Floor

WIDTH: 8.05 m • LENGTH: 7.72 m
AREA: 50.71 m² • PERIMETER: 30.59 m

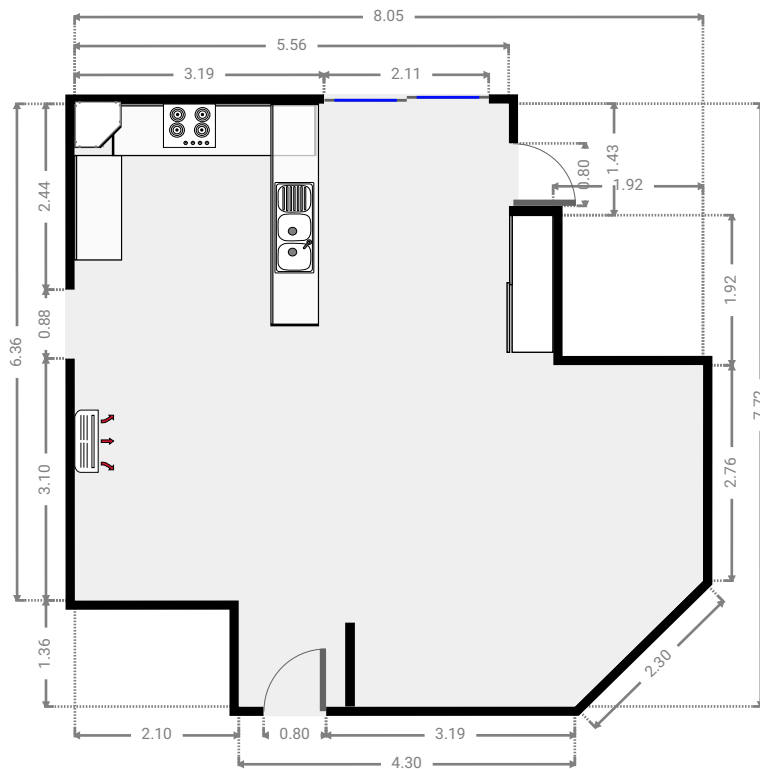
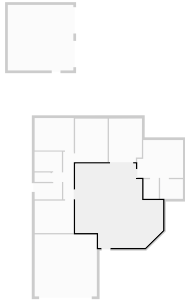

▼ Garage
Ground Floor

WIDTH: 5.69 m • LENGTH: 5.68 m
AREA: 32.30 m² • PERIMETER: 22.73 m

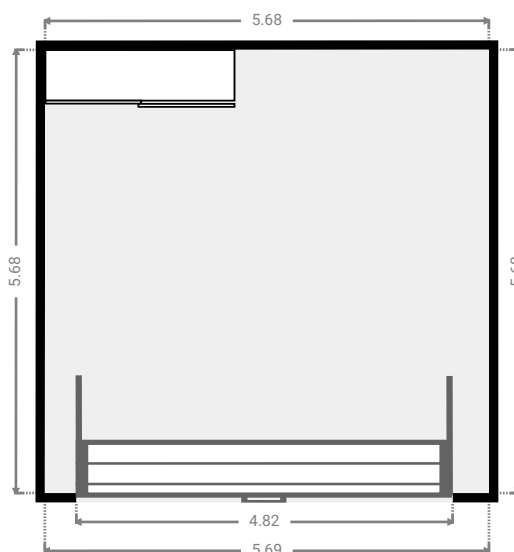
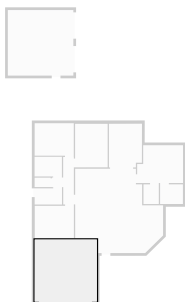

FLOORS: 1

▼ Master Bedroom
Ground Floor

WIDTH: 4.20 m • LENGTH: 3.46 m
AREA: 13.58 m² • PERIMETER: 15.32 m

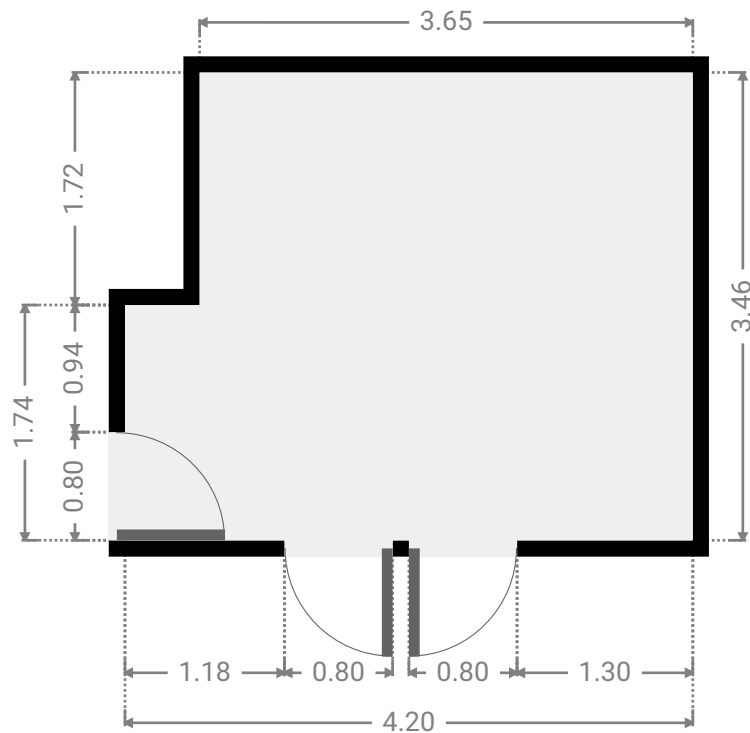
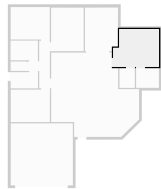

▼ Closet
Ground Floor

WIDTH: 1.40 m • LENGTH: 1.80 m
AREA: 2.52 m² • PERIMETER: 6.40 m

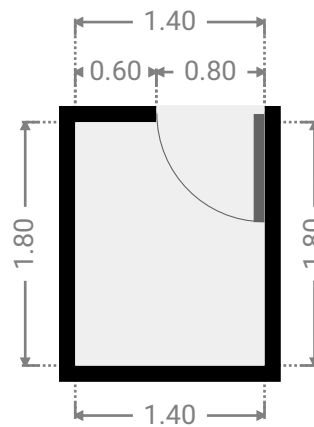
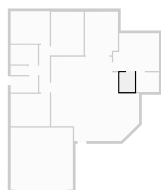

FLOORS: 1

▼ **Bathroom**
Ground Floor

WIDTH: 2.09 m • LENGTH: 1.80 m
AREA: 3.76 m² • PERIMETER: 7.78 m

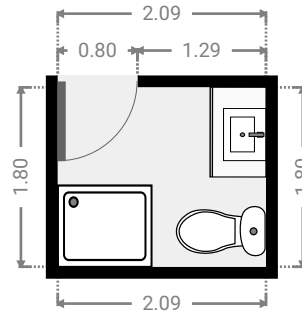
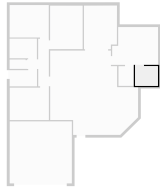

▼ **Hall**
Ground Floor

WIDTH: 2.01 m • LENGTH: 4.35 m
AREA: 5.15 m² • PERIMETER: 12.72 m

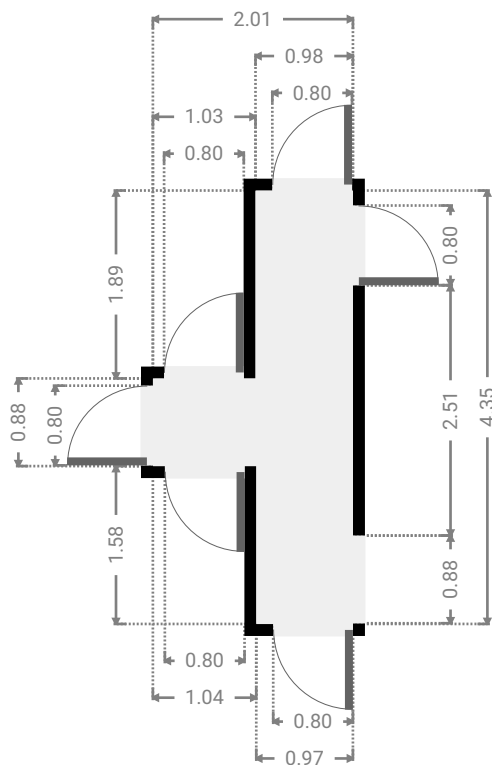
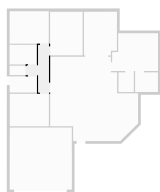

FLOORS: 1

▼ **Bedroom**
Ground Floor

WIDTH: 3.58 m • LENGTH: 2.97 m
AREA: 10.63 m² • PERIMETER: 13.10 m

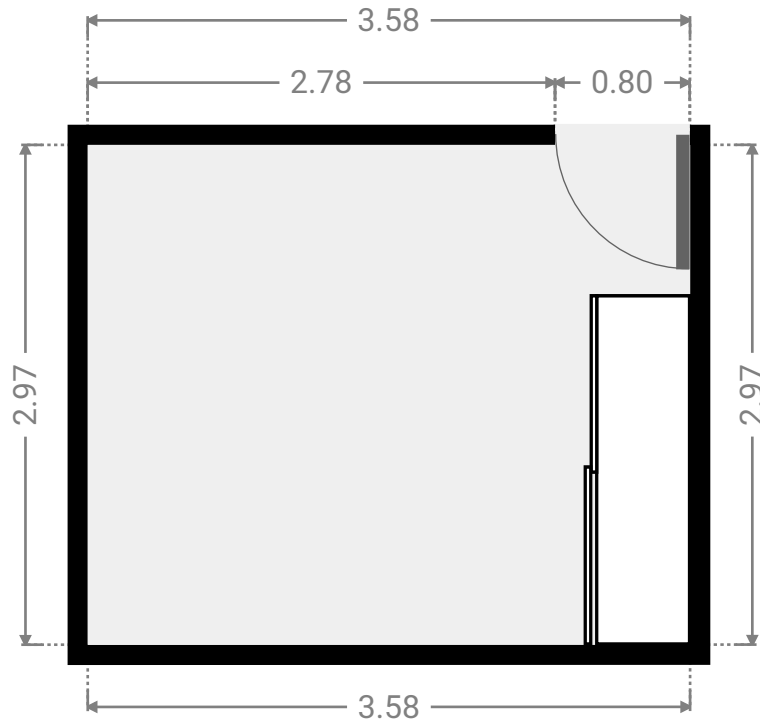
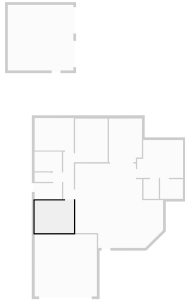

▼ **Laundry Room**
Ground Floor

WIDTH: 2.50 m • LENGTH: 1.48 m
AREA: 3.70 m² • PERIMETER: 7.96 m

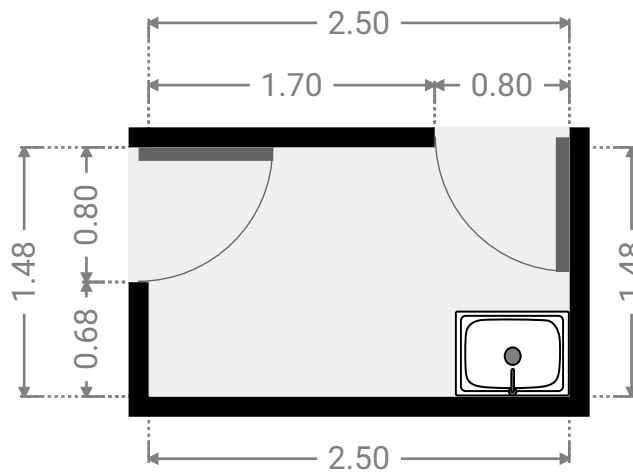
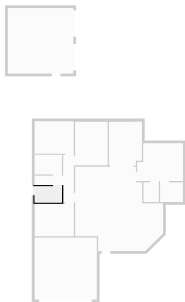

FLOORS: 1

▼ Toilet
Ground Floor

WIDTH: 1.47 m • LENGTH: 0.86 m
AREA: 1.26 m² • PERIMETER: 4.65 m

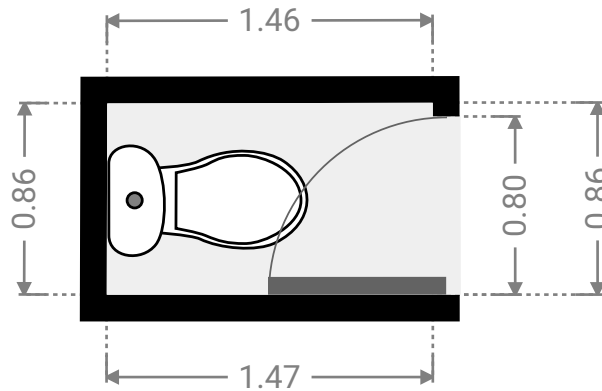
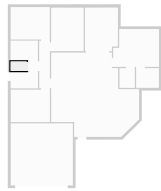

▼ Bathroom
Ground Floor

WIDTH: 2.50 m • LENGTH: 1.80 m
AREA: 4.50 m² • PERIMETER: 8.60 m

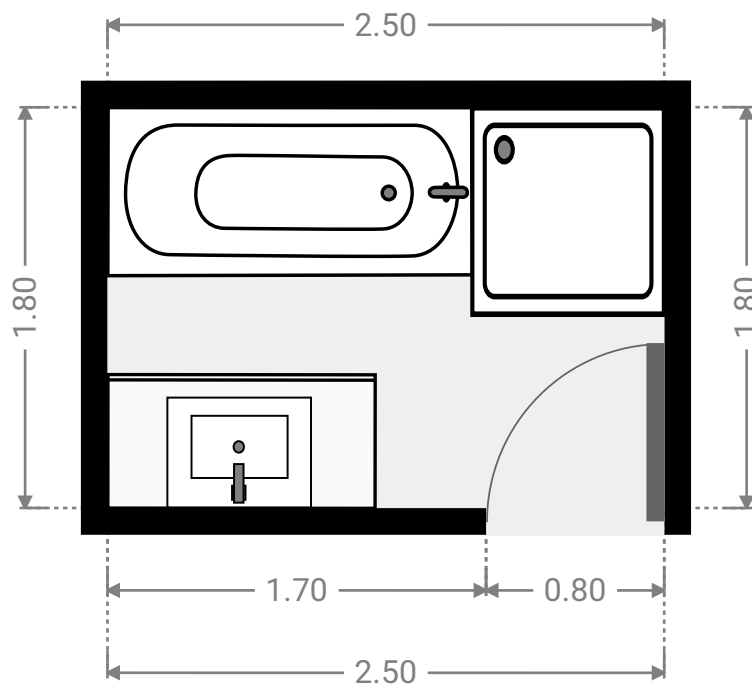
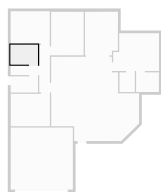

FLOORS: 1

▼ **Bedroom**
Ground Floor

WIDTH: 3.58 m • LENGTH: 2.97 m
AREA: 10.63 m² • PERIMETER: 13.10 m

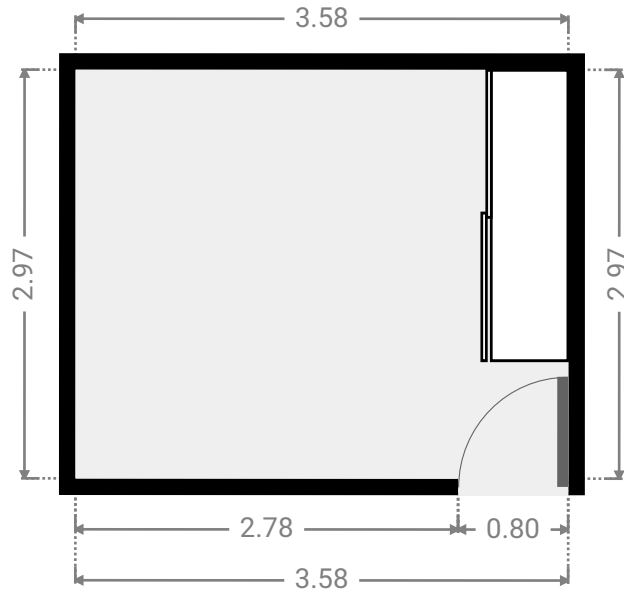
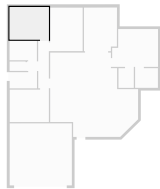

▼ **Bedroom**
Ground Floor

WIDTH: 2.98 m • LENGTH: 3.98 m
AREA: 11.87 m² • PERIMETER: 13.92 m

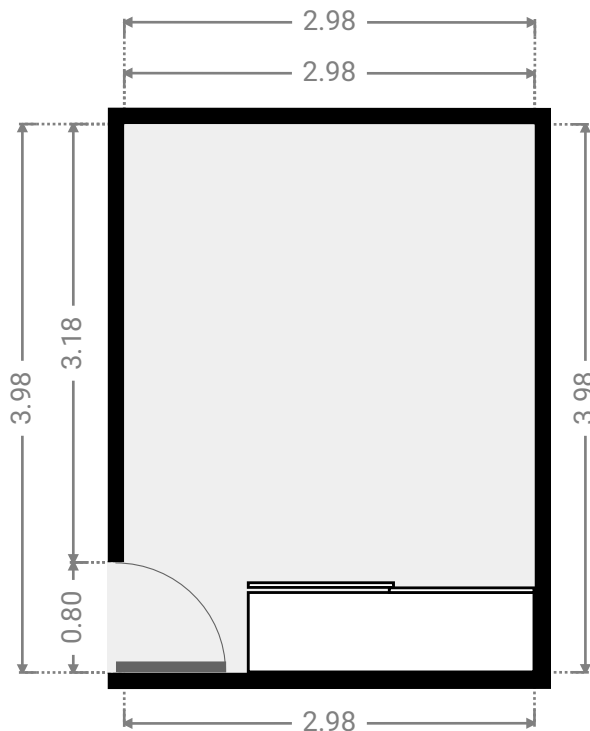
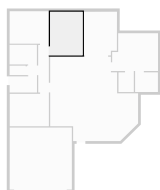

FLOORS: 1

▼ Other
Ground Floor

WIDTH: 3.02 m • LENGTH: 4.00 m
AREA: 11.83 m² • PERIMETER: 14.03 m

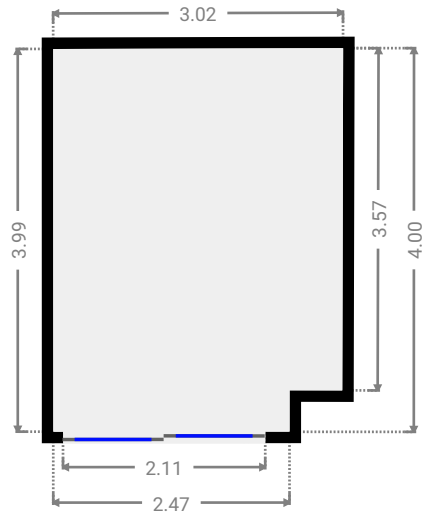
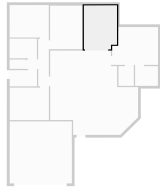

▼ Garage
Ground Floor

WIDTH: 6.00 m • LENGTH: 6.00 m
AREA: 36.00 m² • PERIMETER: 24.00 m

