

325 Pain Street

Ground Floor

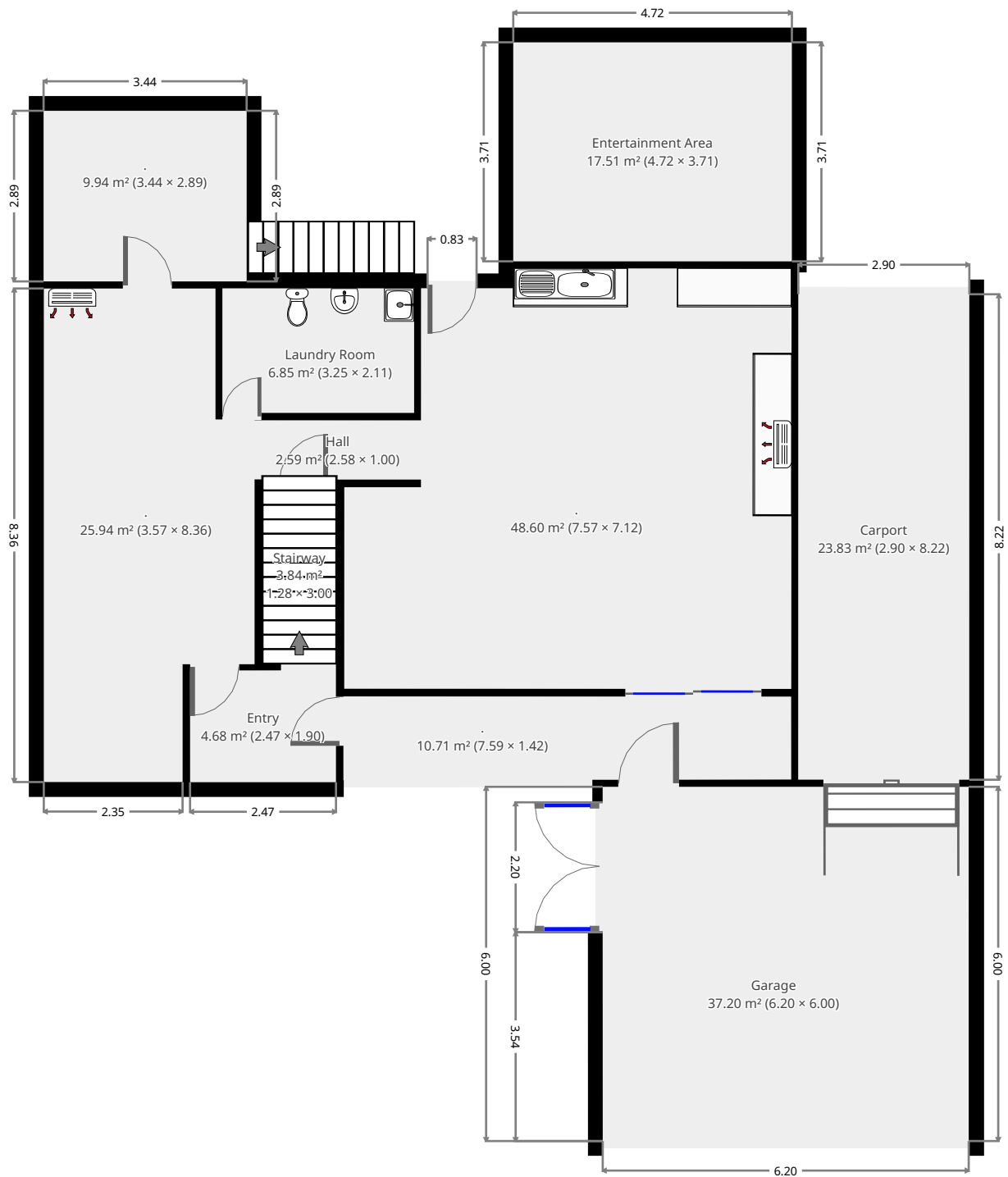

THIS FLOORPLAN IS PROVIDED WITHOUT WARRANTY OF ANY KIND. SENSOPIA DISCLAIMS ANY WARRANTY INCLUDING, WITHOUT LIMITATION, SATISFACTORY QUALITY OR ACCURACY OF DIMENSIONS.

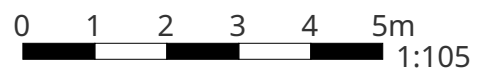

325 Pain Street

Entry

Width: 1.90 m
 Length: 2.47 m
 Area: 4.68 m²
 Perimeter: 8.73 m

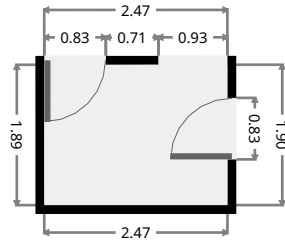
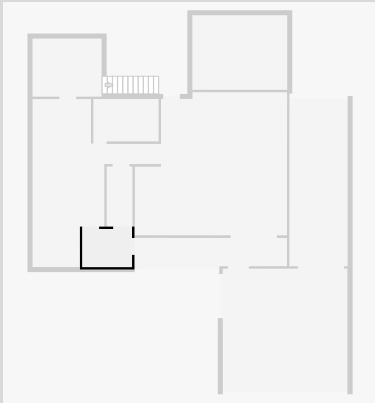

•
 Width: 3.57 m
 Length: 8.36 m
 Area: 25.94 m²
 Perimeter: 23.86 m

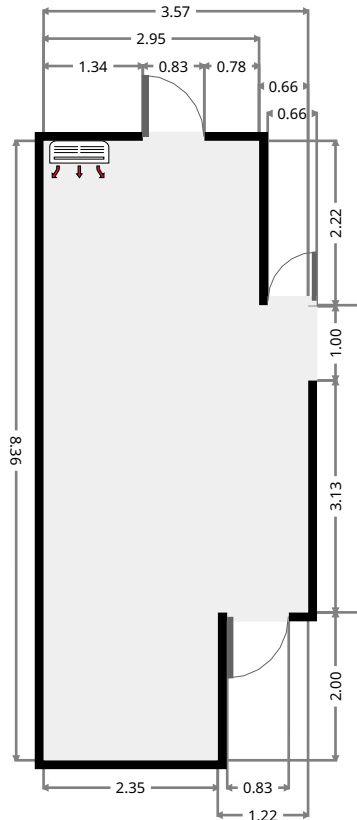
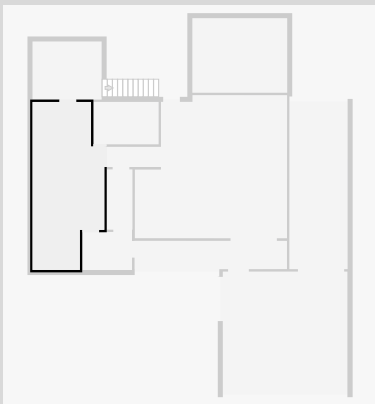

THIS FLOORPLAN IS PROVIDED WITHOUT WARRANTY OF ANY KIND. SENSOPIA DISCLAIMS ANY WARRANTY INCLUDING, WITHOUT LIMITATION, SATISFACTORY QUALITY OR ACCURACY OF DIMENSIONS.

325 Pain Street

Laundry Room

Width: 2.11 m
Length: 3.25 m
Area: 6.85 m²
Perimeter: 10.72 m

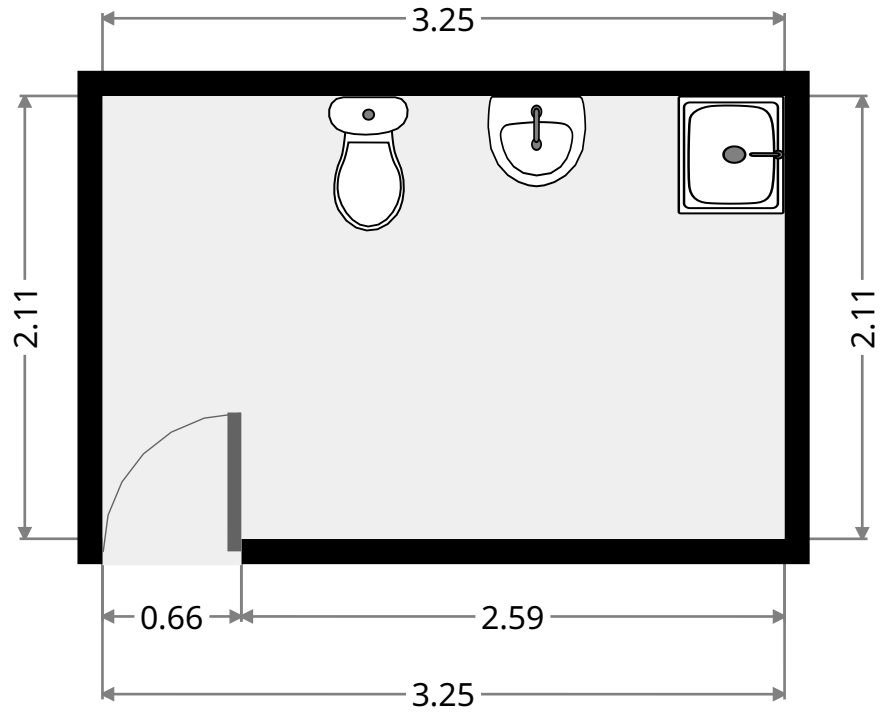
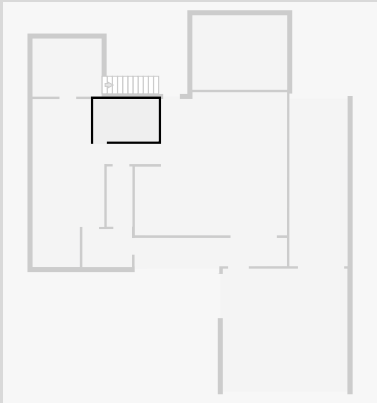

Hall

Width: 1.00 m
Length: 2.58 m
Area: 2.59 m²
Perimeter: 7.17 m

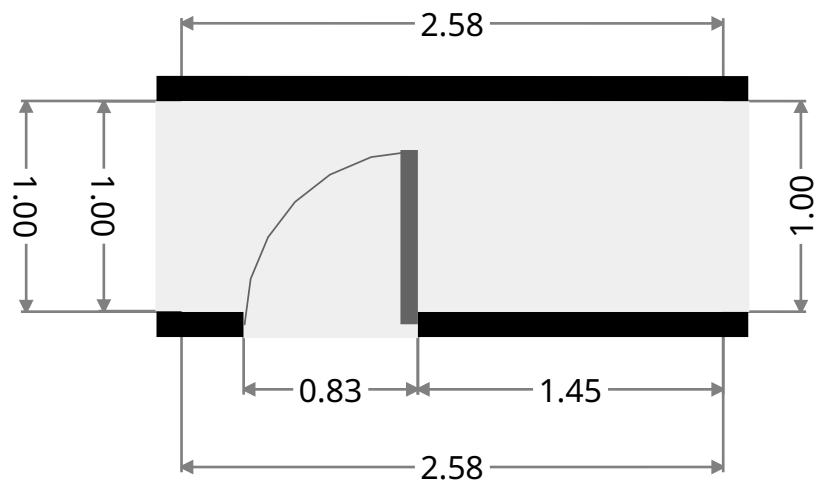
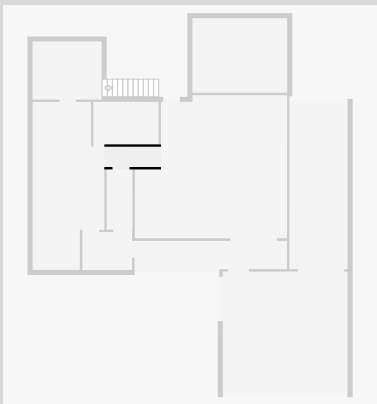

325 Pain Street

•
 Width: 7.12 m
 Length: 7.57 m
 Area: 48.60 m²
 Perimeter: 29.39 m

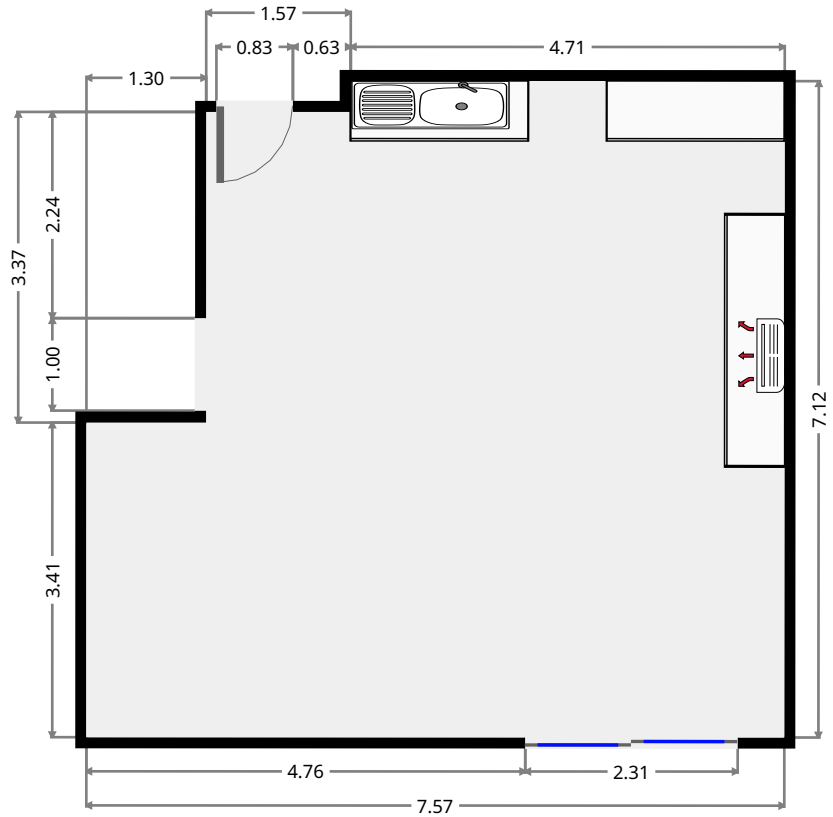
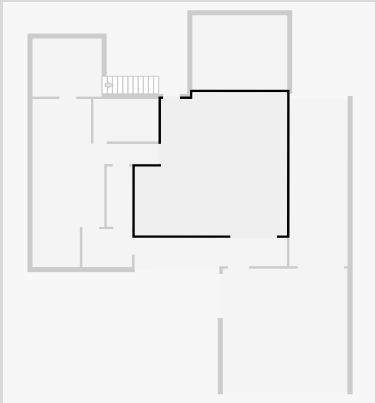

Stairway

Width: 1.28 m
 Length: 3.00 m
 Area: 3.84 m²
 Perimeter: 8.56 m

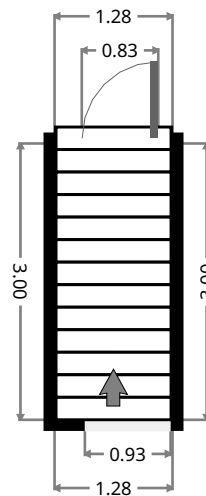
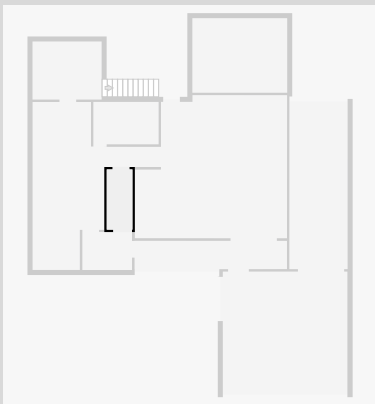

THIS FLOORPLAN IS PROVIDED WITHOUT WARRANTY OF ANY KIND. SENSOPIA DISCLAIMS ANY WARRANTY INCLUDING, WITHOUT LIMITATION, SATISFACTORY QUALITY OR ACCURACY OF DIMENSIONS.



325 Pain Street

•
Width: 2.89 m
Length: 3.44 m
Area: 9.94 m²
Perimeter: 12.66 m

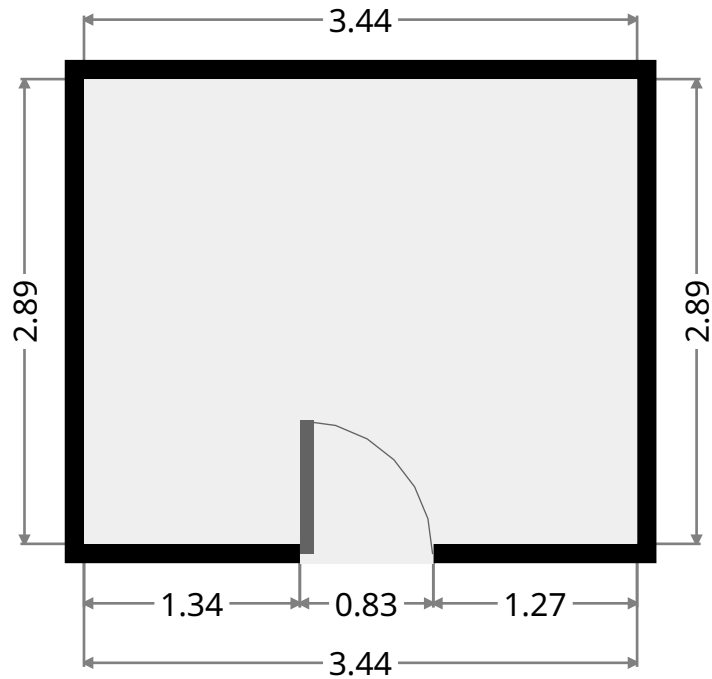
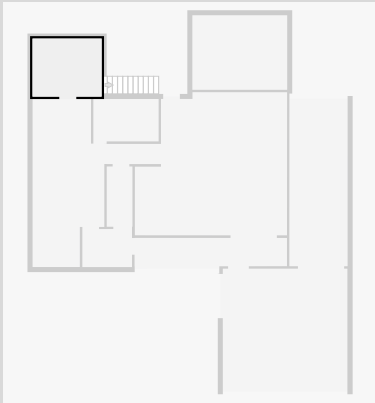

Entertainment Area

Width: 3.71 m
Length: 4.72 m
Area: 17.51 m²
Perimeter: 16.86 m

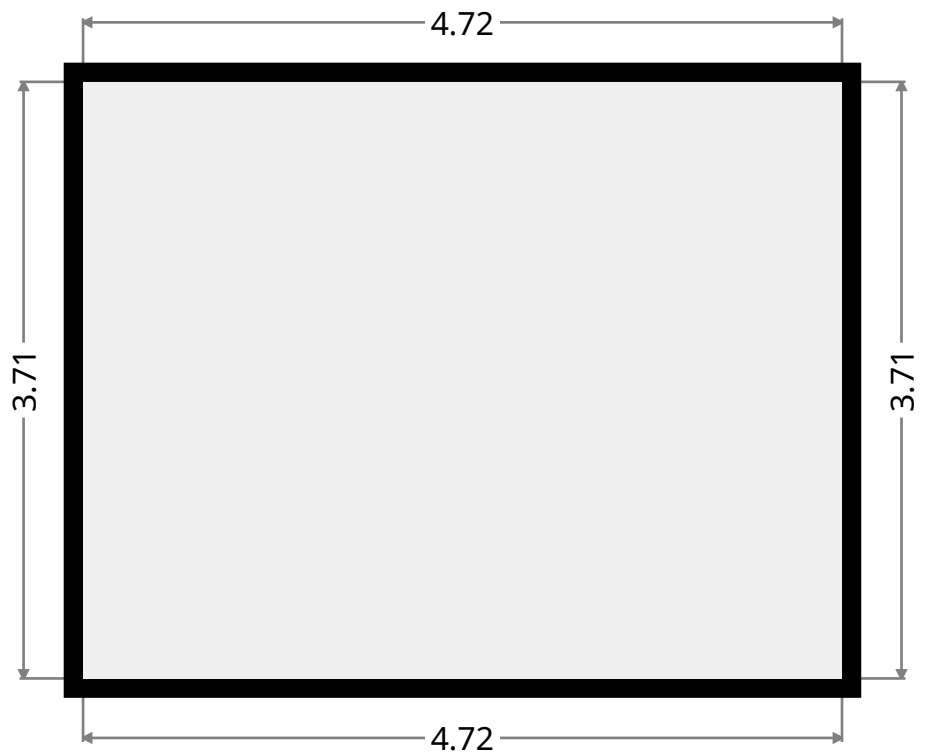
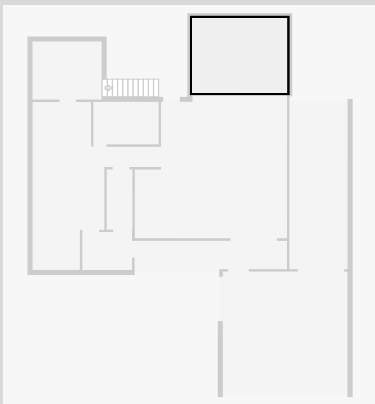

325 Pain Street

•
 Width: 1.42 m
 Length: 7.59 m
 Area: 10.71 m²
 Perimeter: 18.00 m

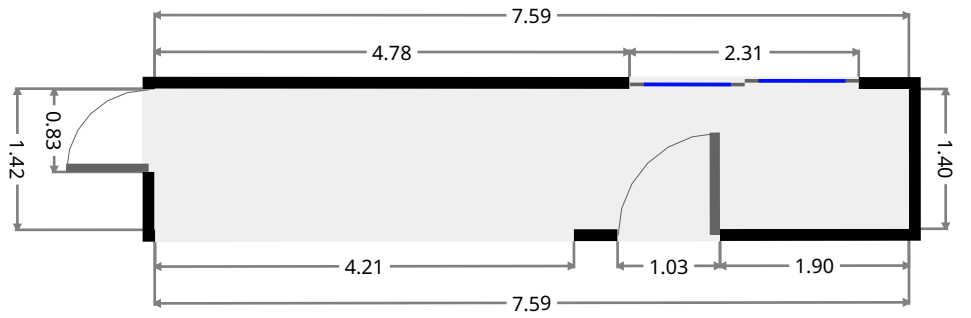
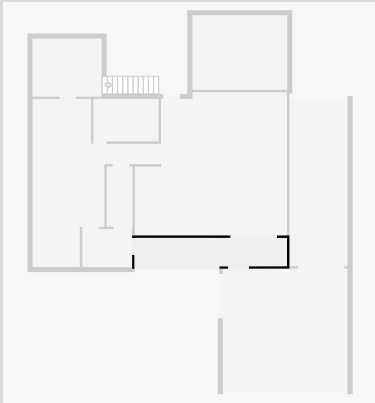

Garage

Width: 6.00 m
 Length: 6.20 m
 Area: 37.20 m²
 Perimeter: 24.40 m

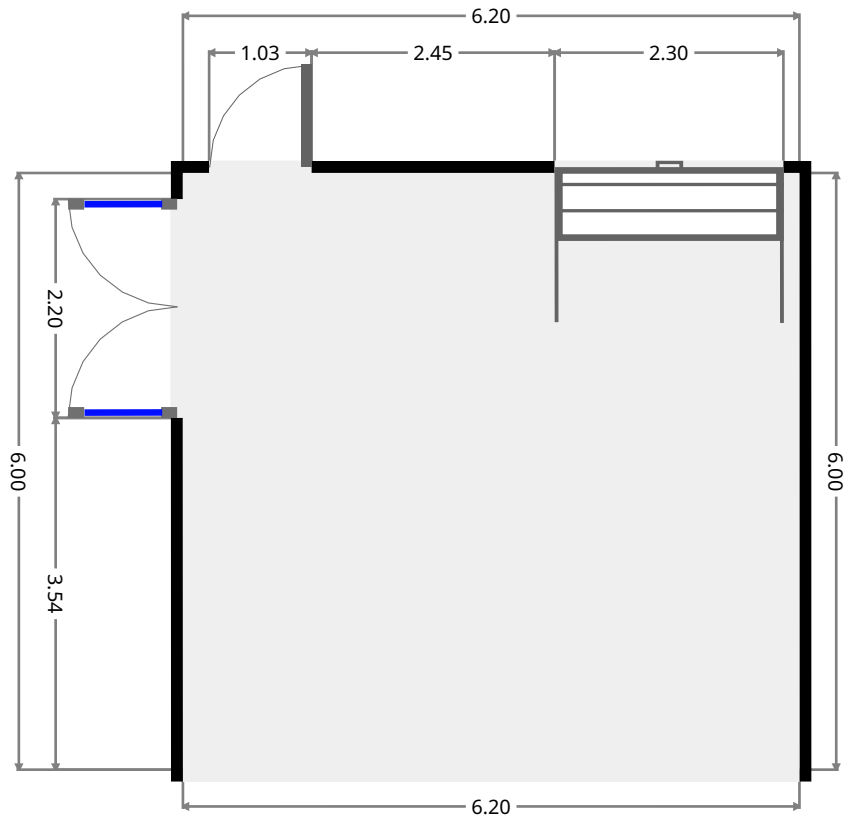
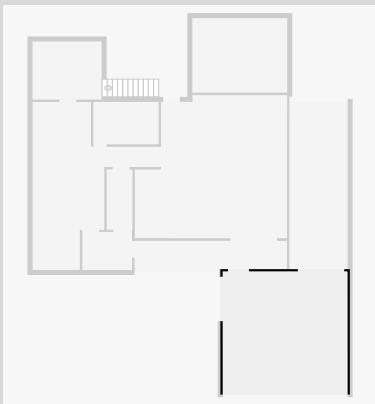

THIS FLOORPLAN IS PROVIDED WITHOUT WARRANTY OF ANY KIND. SENSOPIA DISCLAIMS ANY WARRANTY INCLUDING, WITHOUT LIMITATION, SATISFACTORY QUALITY OR ACCURACY OF DIMENSIONS.

325 Pain Street

Carport

Width: 2.90 m
Length: 8.22 m
Area: 23.83 m²
Perimeter: 22.24 m

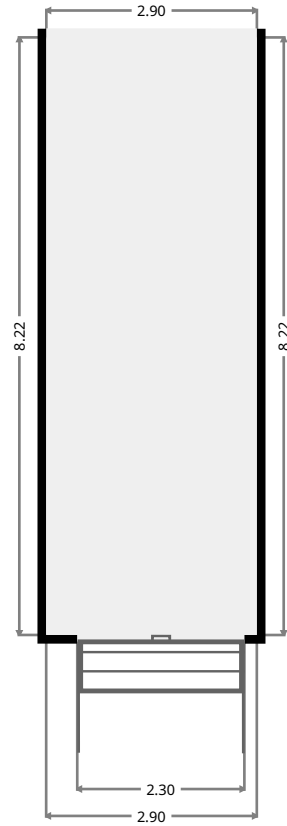
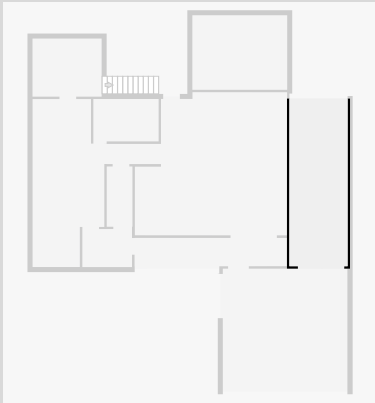

325 Pain Street

1st Floor

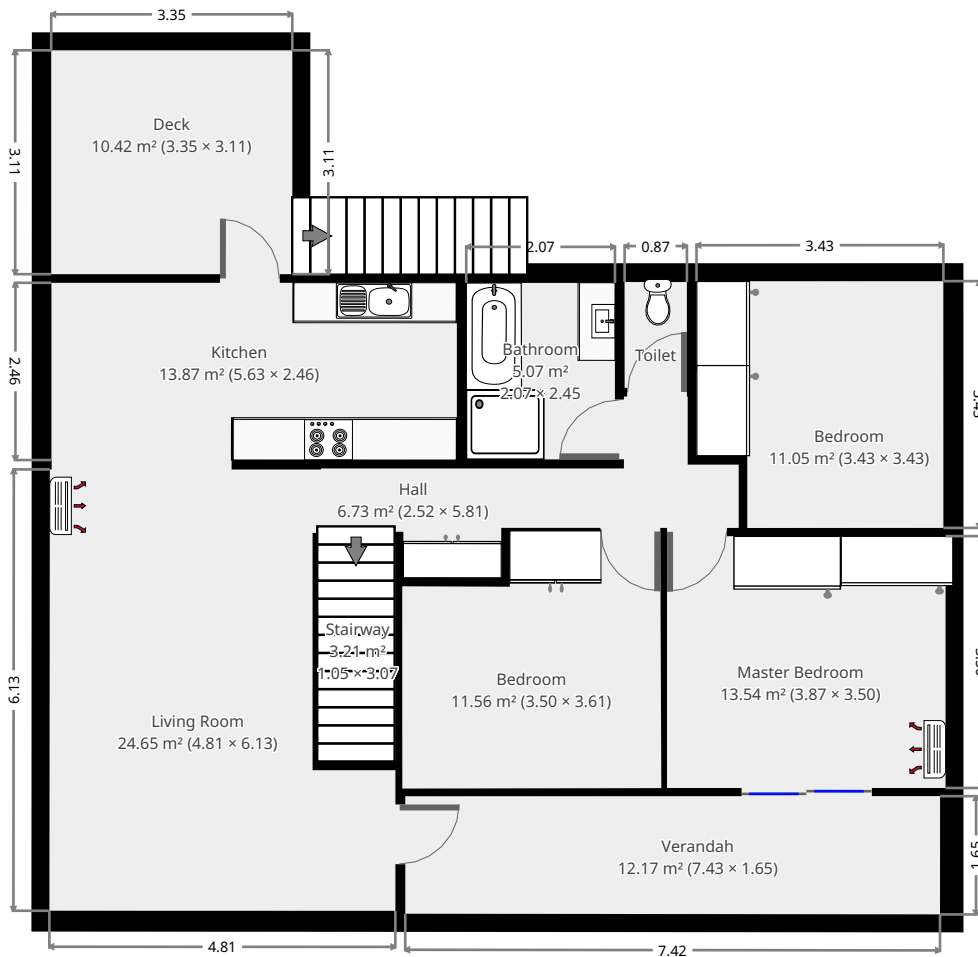

THIS FLOORPLAN IS PROVIDED WITHOUT WARRANTY OF ANY KIND. SENSOPIA DISCLAIMS ANY WARRANTY INCLUDING, WITHOUT LIMITATION, SATISFACTORY QUALITY OR ACCURACY OF DIMENSIONS.

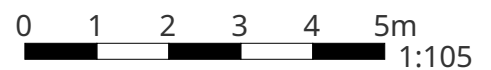

325 Pain Street

Living Room

Width: 4.81 m
 Length: 6.13 m
 Area: 24.65 m²
 Perimeter: 21.87 m

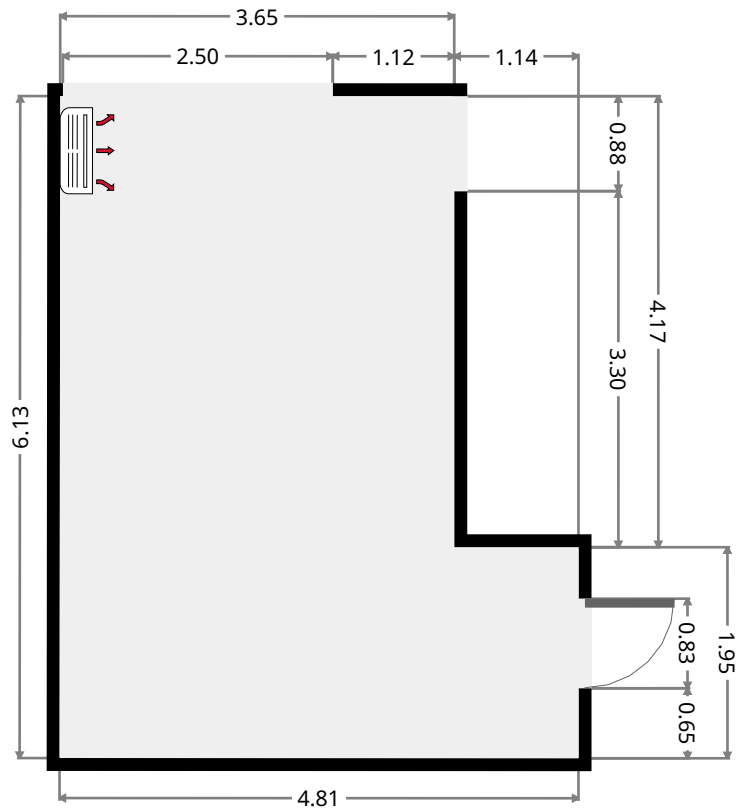
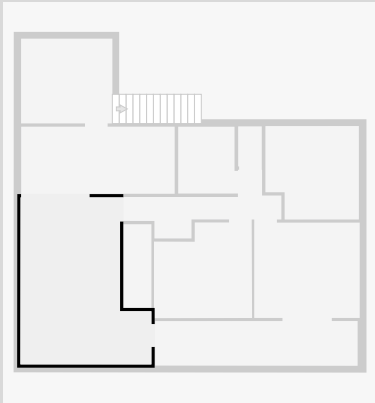

Kitchen

Width: 2.46 m
 Length: 5.63 m
 Area: 13.87 m²
 Perimeter: 16.19 m

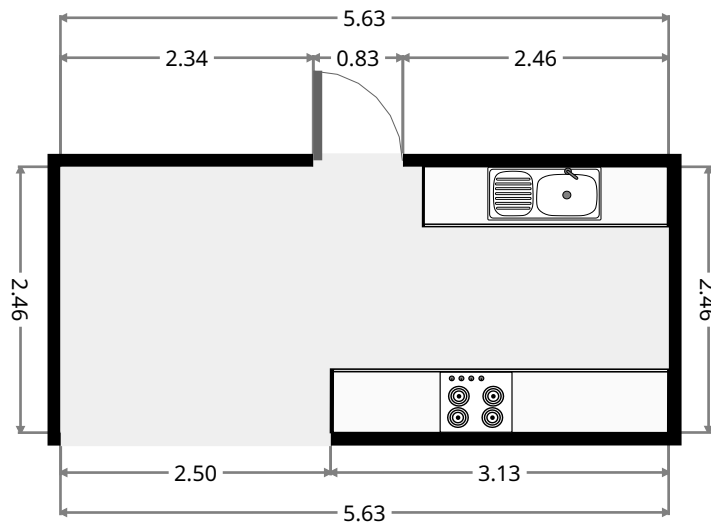
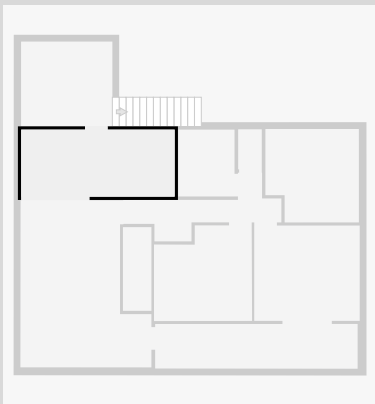

325 Pain Street

Hall

Width: 2.52 m
 Length: 5.81 m
 Area: 6.73 m²
 Perimeter: 16.65 m

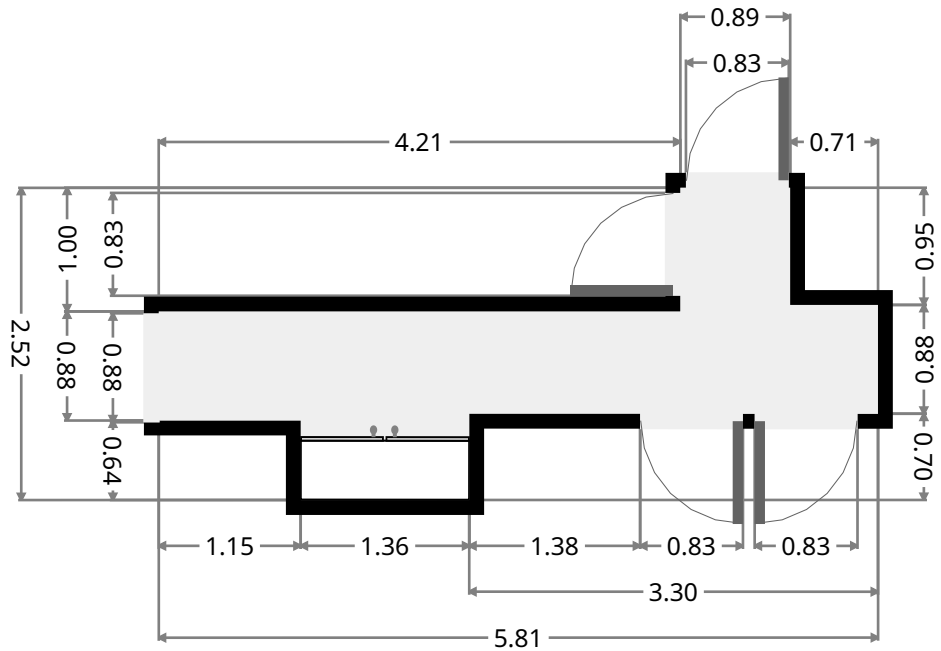
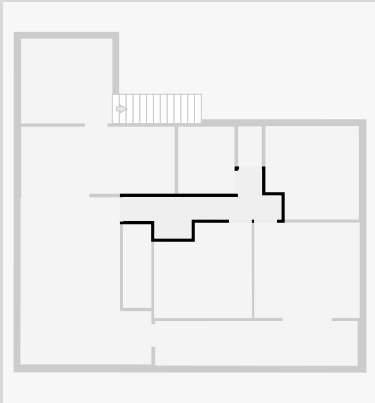

Stairway

Width: 1.05 m
 Length: 3.07 m
 Area: 3.21 m²
 Perimeter: 8.23 m

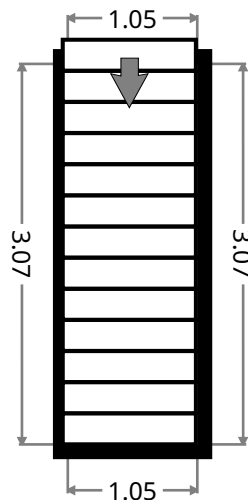
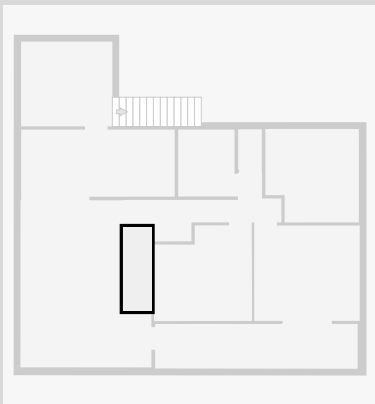

325 Pain Street

Bedroom

Width: 3.50 m
 Length: 3.61 m
 Area: 11.56 m²
 Perimeter: 14.21 m

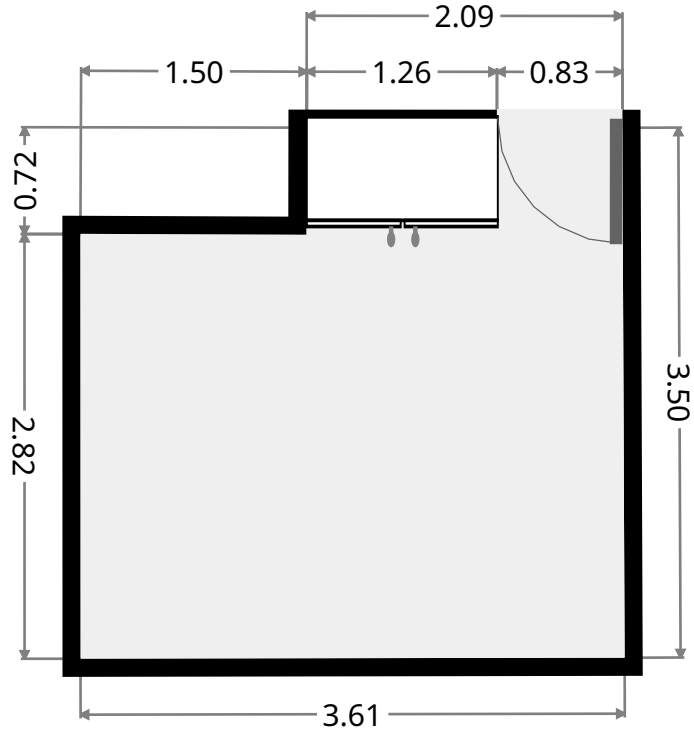
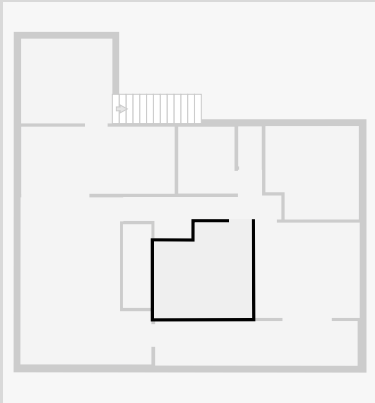

Master Bedroom

Width: 3.50 m
 Length: 3.87 m
 Area: 13.54 m²
 Perimeter: 14.74 m

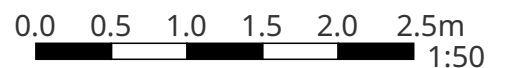
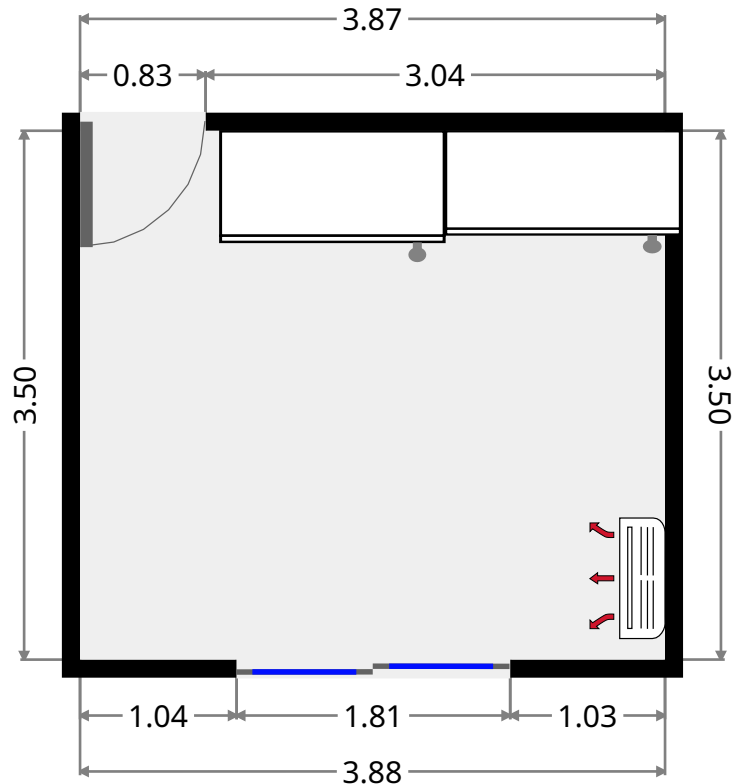
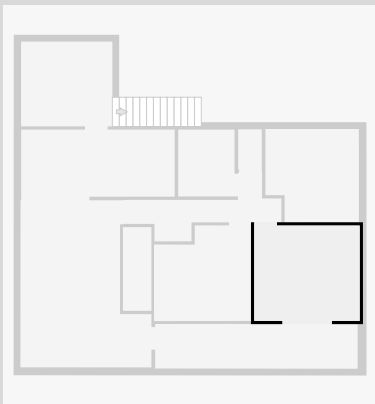

THIS FLOORPLAN IS PROVIDED WITHOUT WARRANTY OF ANY KIND. SENSOPIA DISCLAIMS ANY WARRANTY INCLUDING, WITHOUT LIMITATION, SATISFACTORY QUALITY OR ACCURACY OF DIMENSIONS.

325 Pain Street

Verandah

Width: 1.65 m
Length: 7.43 m
Area: 12.17 m²
Perimeter: 18.14 m

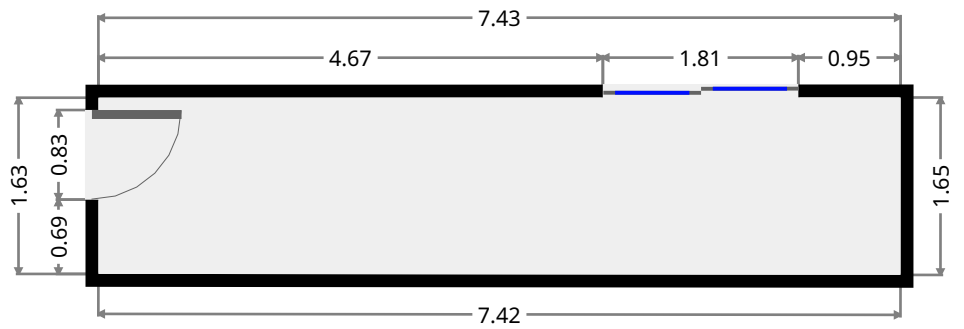
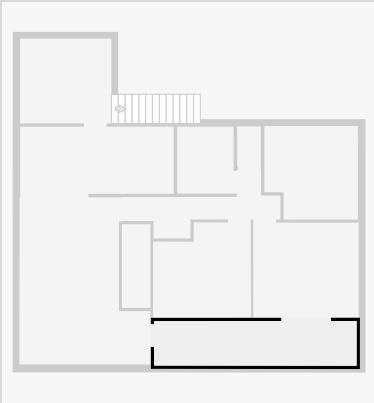

Bedroom

Width: 3.43 m
Length: 3.43 m
Area: 11.05 m²
Perimeter: 13.72 m

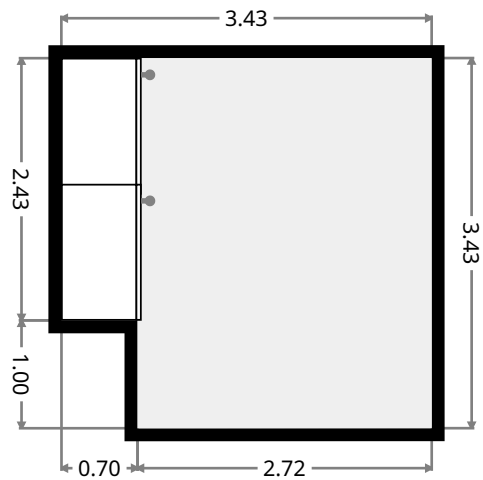
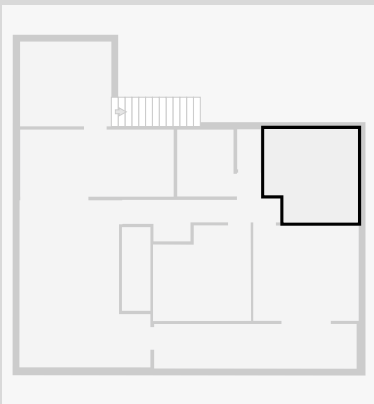

325 Pain Street

Bathroom

Width: 2.07 m
Length: 2.45 m
Area: 5.07 m²
Perimeter: 9.04 m

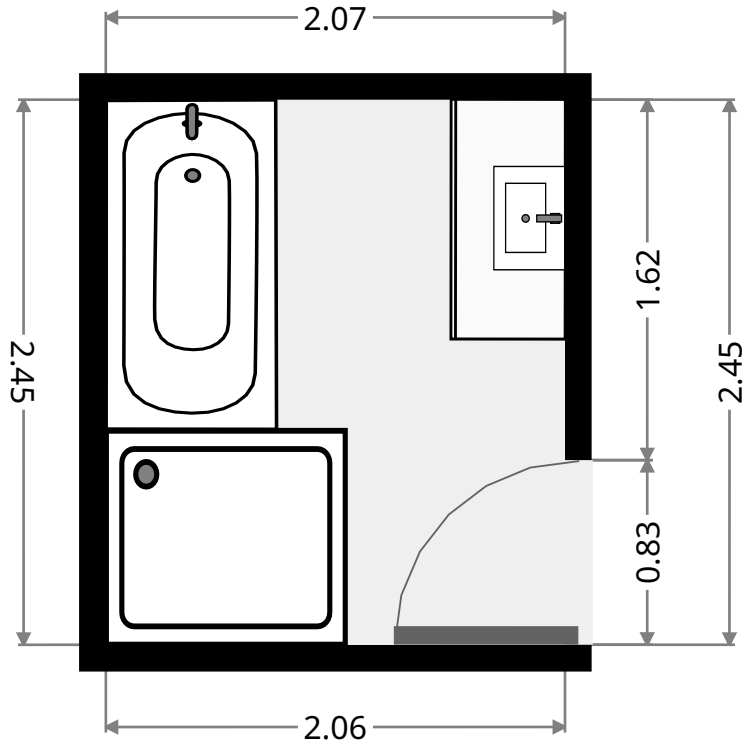
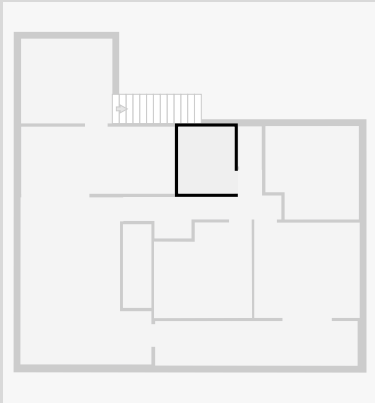

Toilet

Width: 0.87 m
Length: 1.47 m
Area: 1.27 m²
Perimeter: 4.67 m

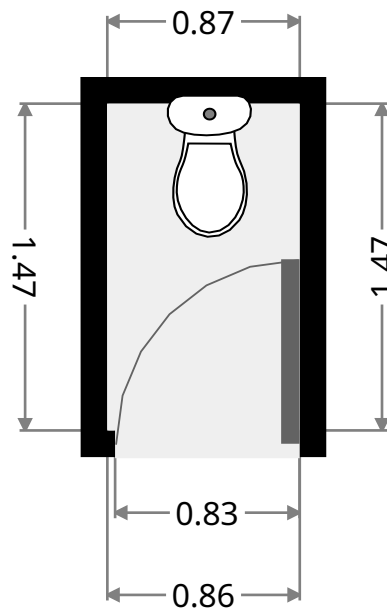
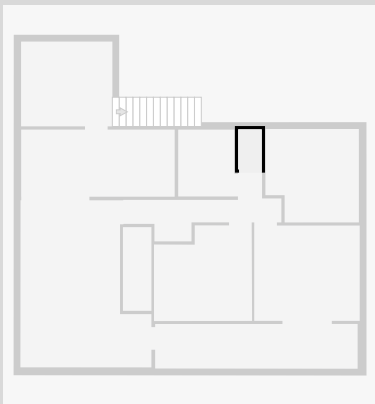

325 Pain Street

Deck

Width: 3.11 m
Length: 3.35 m
Area: 10.42 m²
Perimeter: 12.92 m

