

# 32 Thackeray Street

Created on  
2020-06-23

Floors  
2

## ▼ Ground Floor

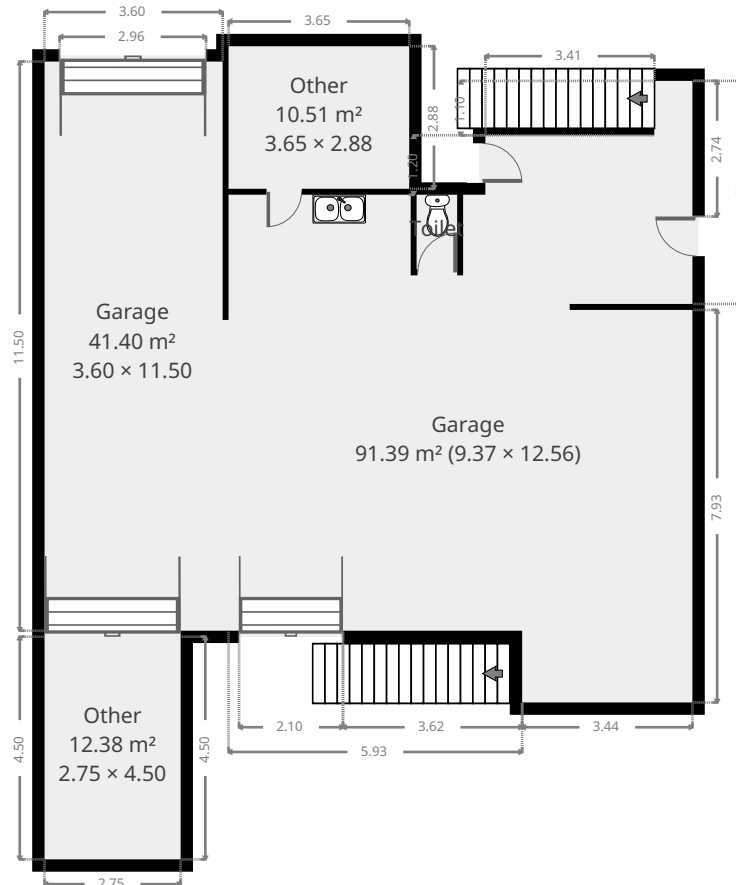
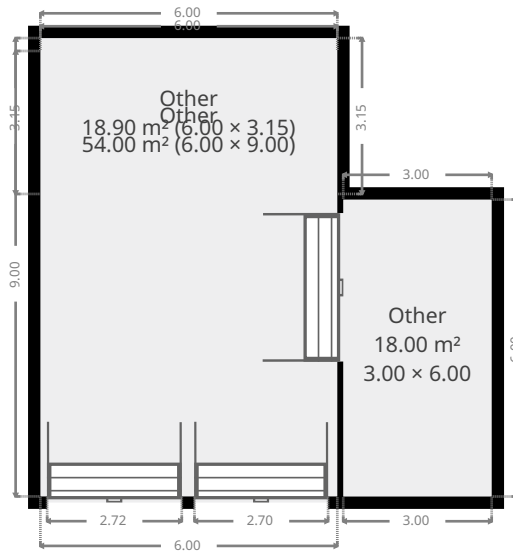

FLOORS: 2

## ▼ Garage Ground Floor

WIDTH: 3.60 m • LENGTH: 11.50 m  
AREA: 41.40 m<sup>2</sup> • PERIMETER: 30.20 m

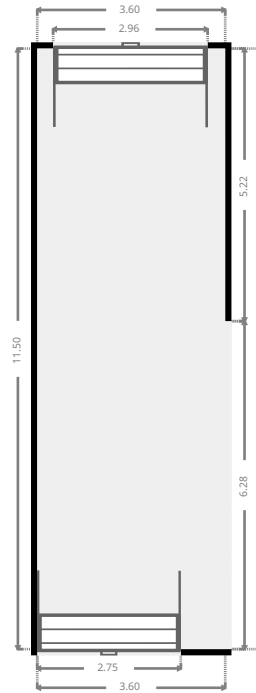
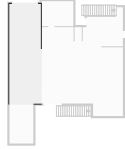

## ▼ Garage Ground Floor

WIDTH: 9.37 m • LENGTH: 12.56 m  
AREA: 91.39 m<sup>2</sup> • PERIMETER: 52.08 m

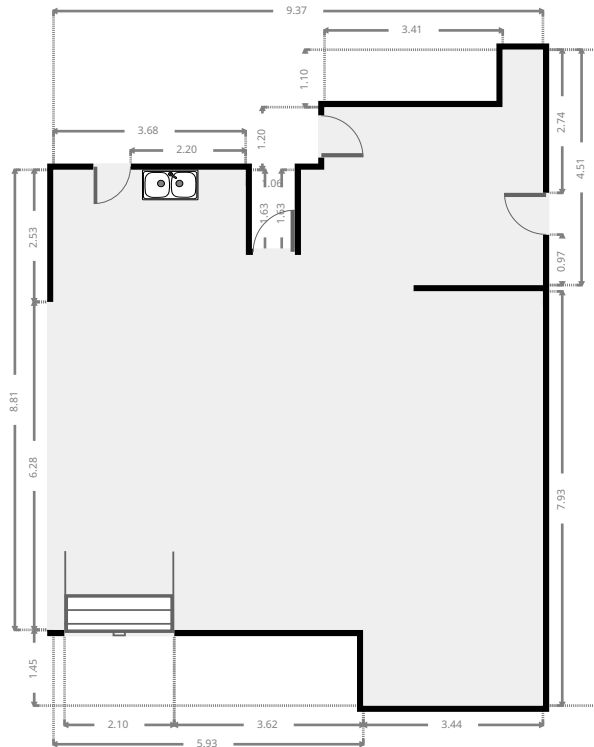
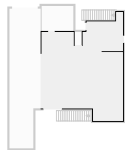

THIS FLOORPLAN IS PROVIDED WITHOUT WARRANTY OF ANY KIND. SENSOPIA DISCLAIMS ANY WARRANTY INCLUDING, WITHOUT LIMITATION, SATISFACTORY QUALITY OR ACCURACY OF DIMENSIONS.

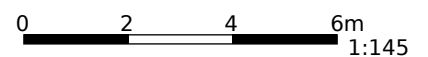

FLOORS: 2

## ▼ Toilet Ground Floor

WIDTH: 0.82 m • LENGTH: 1.51 m  
AREA: 1.24 m<sup>2</sup> • PERIMETER: 4.66 m

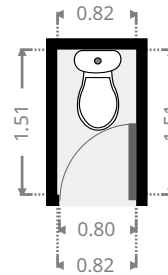

## ▼ Other Ground Floor

WIDTH: 2.75 m • LENGTH: 4.50 m  
AREA: 12.38 m<sup>2</sup> • PERIMETER: 14.50 m

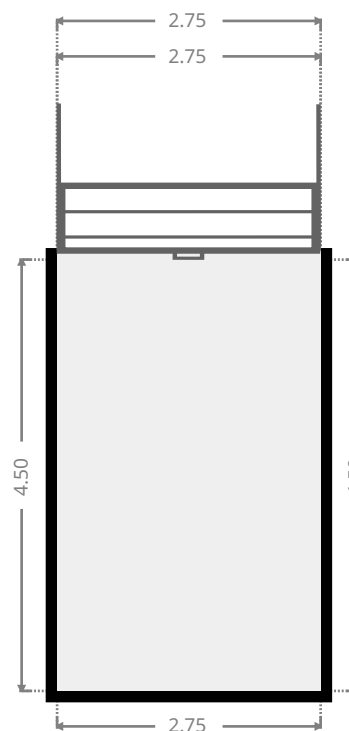

FLOORS: 2

## ▼ Other Ground Floor

WIDTH: 6.00 m • LENGTH: 9.00 m  
AREA: 54.00 m<sup>2</sup> • PERIMETER: 30.00 m

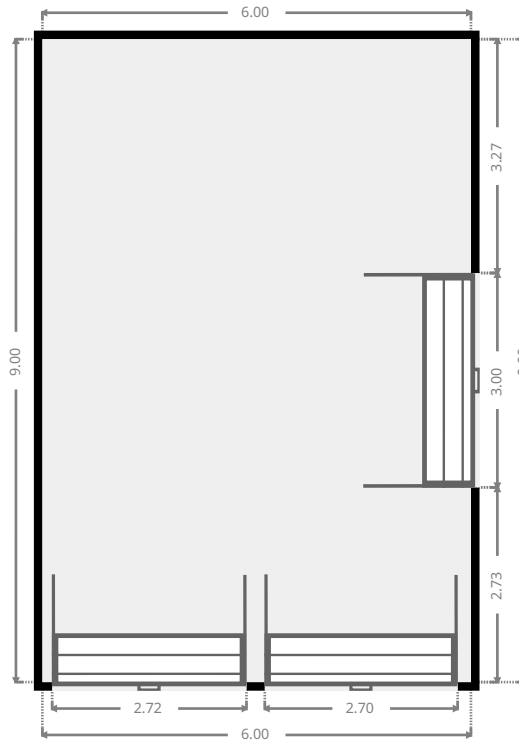

## ▼ Other Ground Floor

WIDTH: 6.00 m • LENGTH: 3.15 m  
AREA: 18.90 m<sup>2</sup> • PERIMETER: 18.30 m



FLOORS: 2

## ▼ Other Ground Floor

WIDTH: 3.00 m • LENGTH: 6.00 m  
AREA: 18.00 m<sup>2</sup> • PERIMETER: 18.00 m

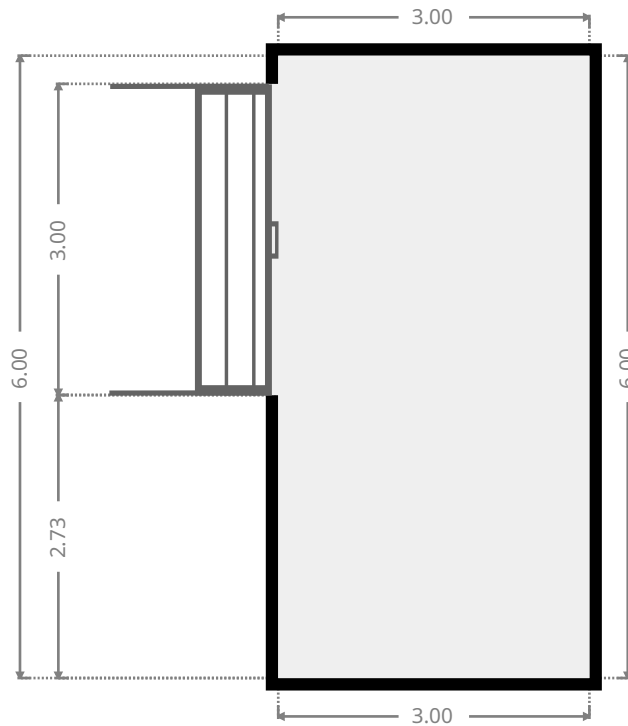

## ▼ Other Ground Floor

WIDTH: 3.65 m • LENGTH: 2.88 m  
AREA: 10.51 m<sup>2</sup> • PERIMETER: 13.06 m

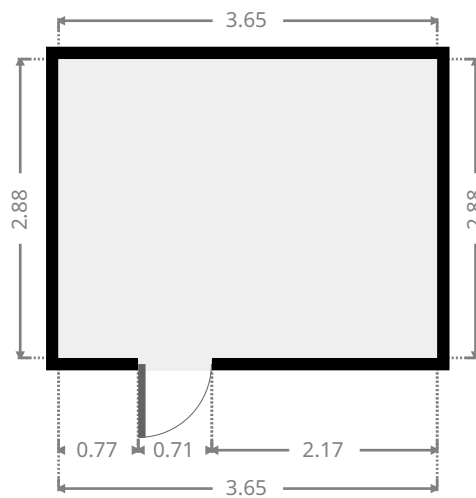
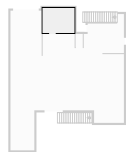

## ▼ 1st Floor

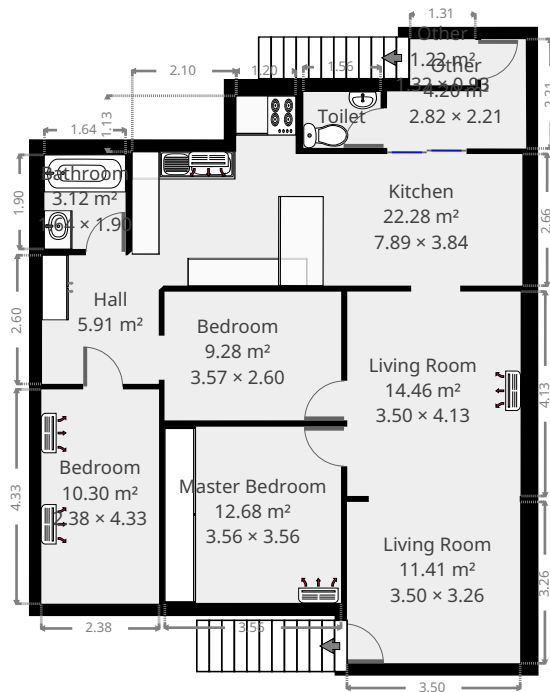

▼ **Other**  
1st Floor

WIDTH: 2.82 m • LENGTH: 2.21 m  
AREA: 4.20 m<sup>2</sup> • PERIMETER: 10.03 m

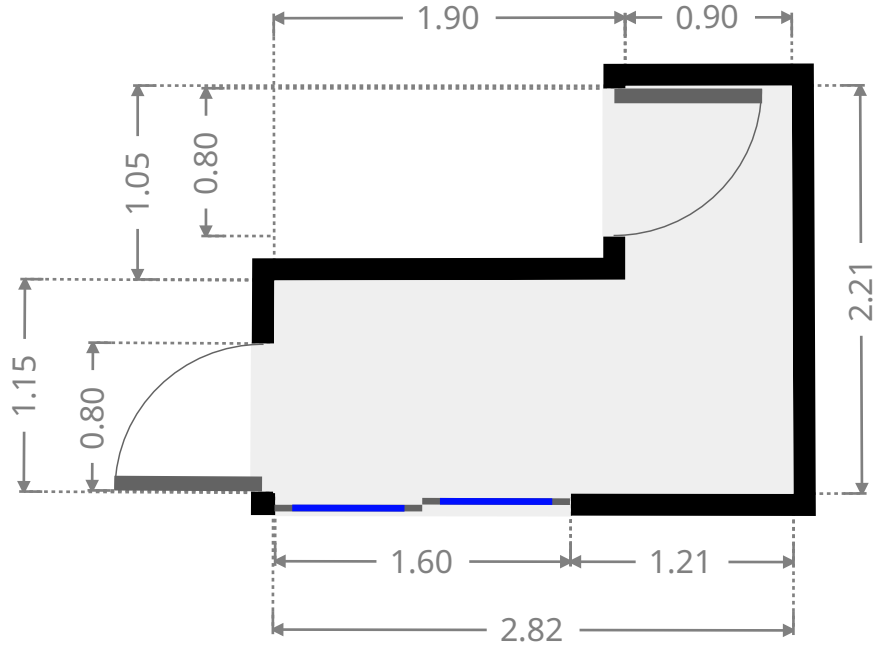
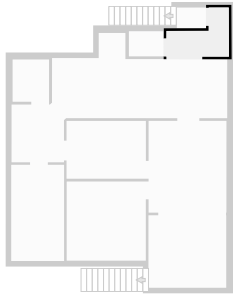

▼ **Toilet**  
1st Floor

WIDTH: 1.56 m • LENGTH: 1.13 m  
AREA: 1.76 m<sup>2</sup> • PERIMETER: 5.38 m

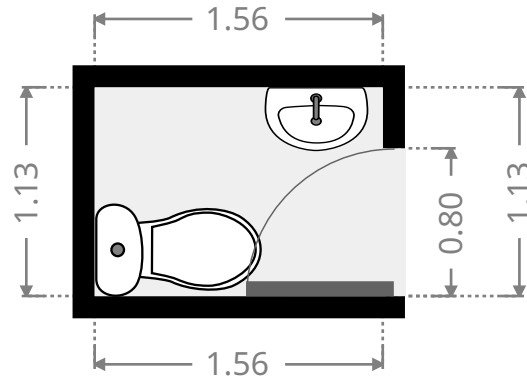
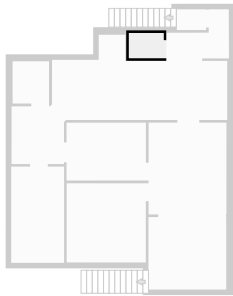



▼ **Kitchen**  
1st Floor

WIDTH: 7.89 m • LENGTH: 3.84 m  
AREA: 22.28 m<sup>2</sup> • PERIMETER: 23.07 m

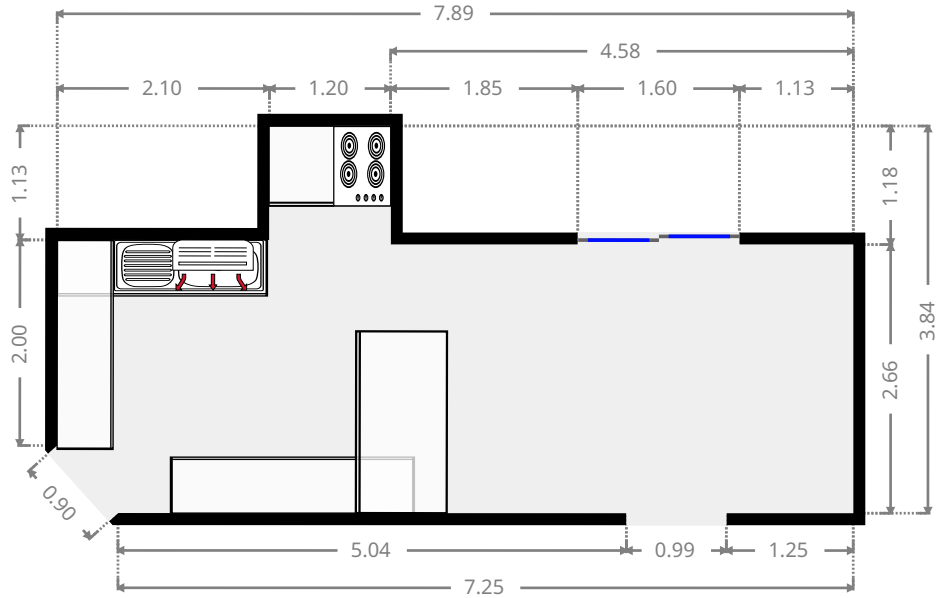
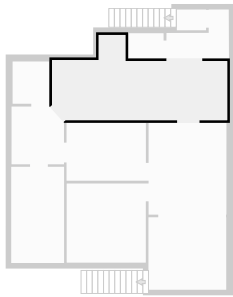

▼ **Living Room**  
1st Floor

WIDTH: 3.50 m • LENGTH: 4.13 m  
AREA: 14.46 m<sup>2</sup> • PERIMETER: 15.26 m

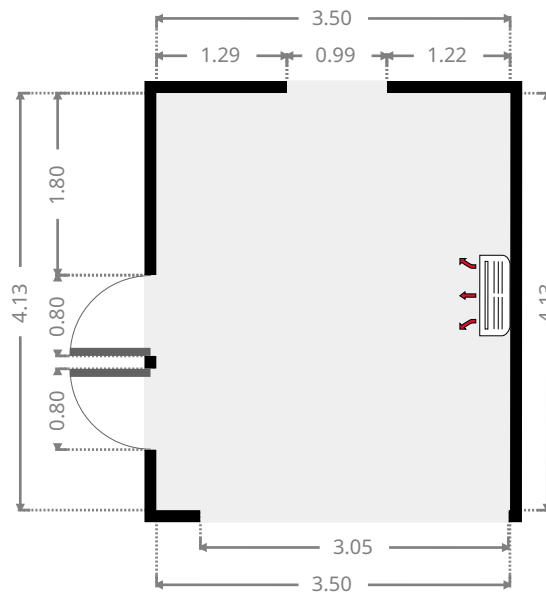
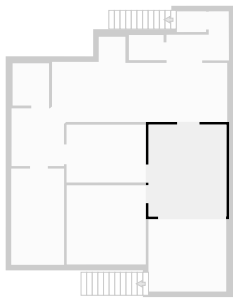

FLOORS: 2

▼ **Living Room**  
1st Floor

WIDTH: 3.50 m • LENGTH: 3.26 m  
AREA: 11.41 m<sup>2</sup> • PERIMETER: 13.52 m

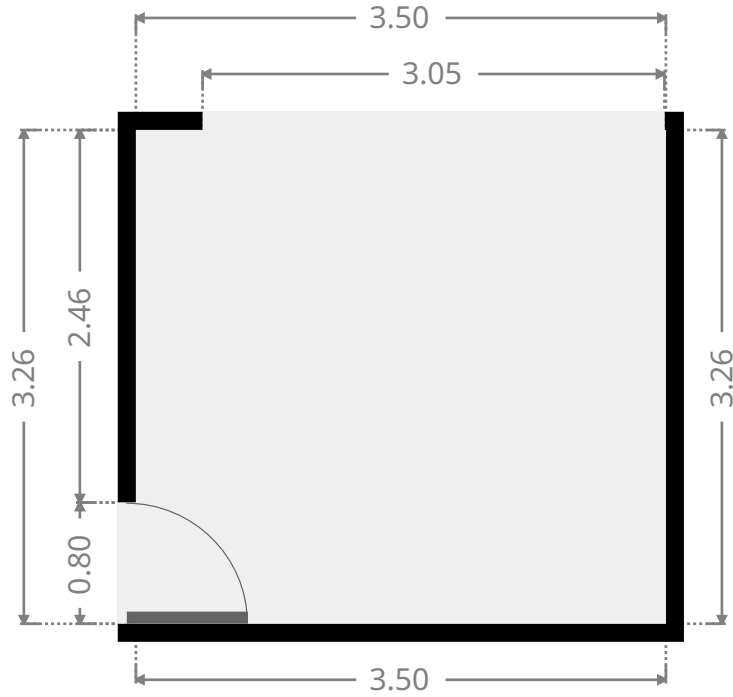
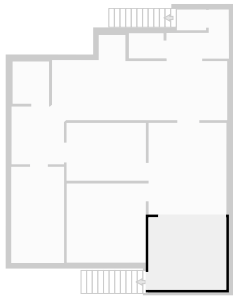

▼ **Bedroom**  
1st Floor

WIDTH: 3.57 m • LENGTH: 2.60 m  
AREA: 9.28 m<sup>2</sup> • PERIMETER: 12.34 m

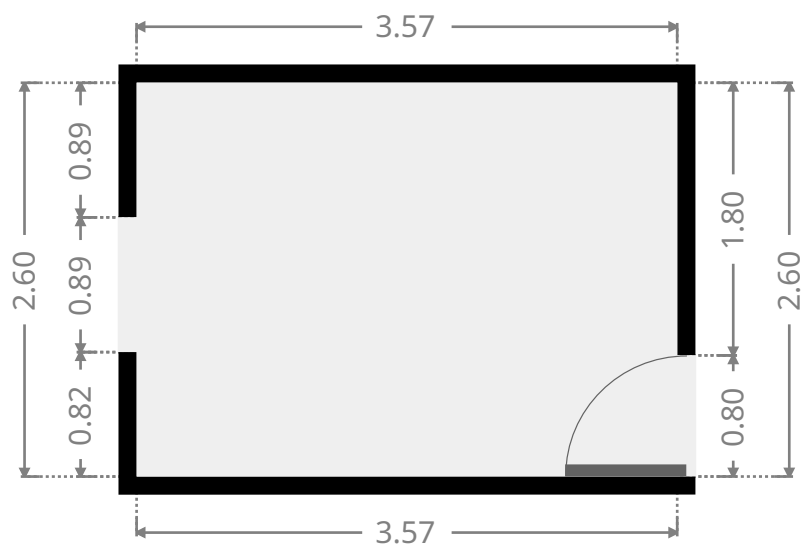
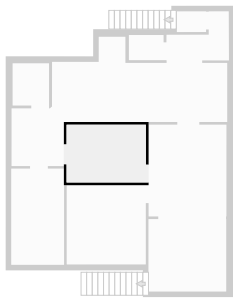

▼ **Master Bedroom**  
1st Floor

WIDTH: 3.56 m • LENGTH: 3.56 m  
AREA: 12.68 m<sup>2</sup> • PERIMETER: 14.24 m

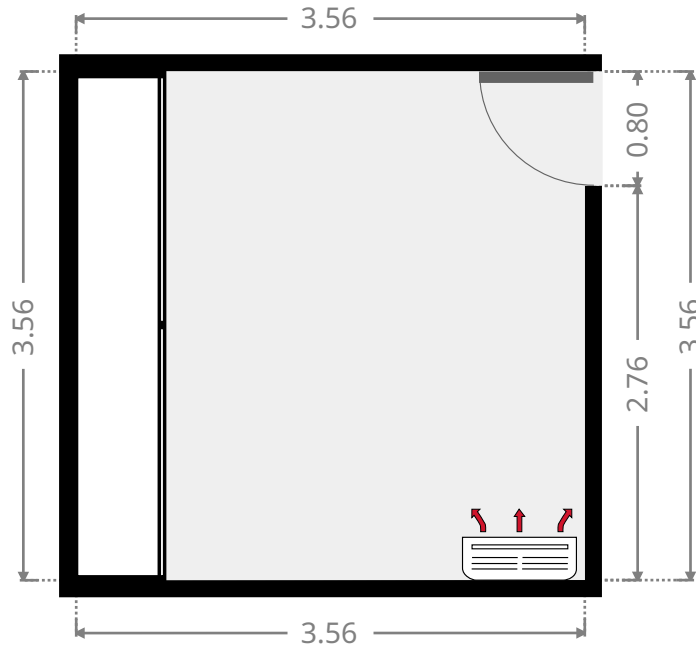
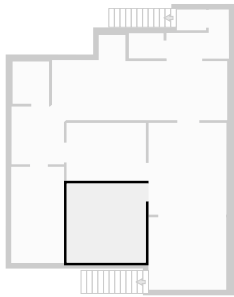

▼ **Hall**  
1st Floor

WIDTH: 2.36 m • LENGTH: 2.60 m  
AREA: 5.91 m<sup>2</sup> • PERIMETER: 9.53 m

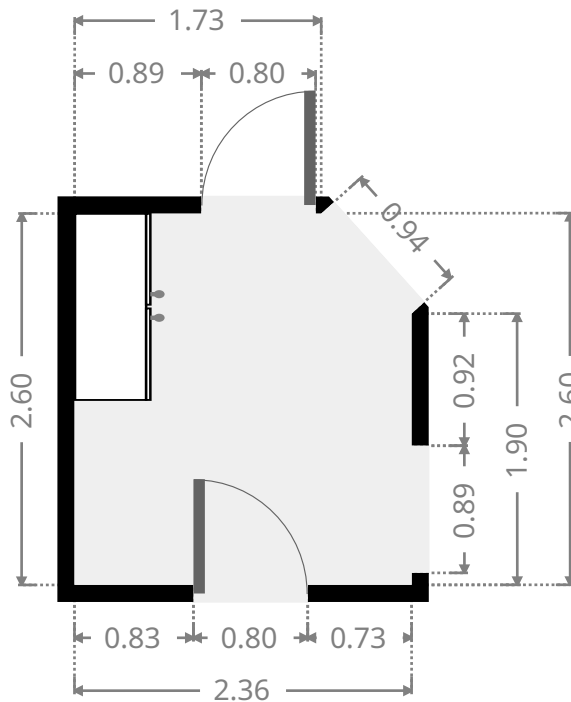
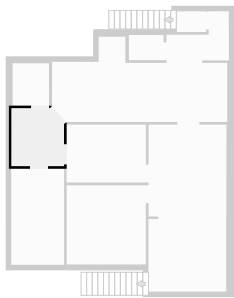

▼ **Bathroom**  
1st Floor

**WIDTH:** 1.64 m • **LENGTH:** 1.90 m  
**AREA:** 3.12 m<sup>2</sup> • **PERIMETER:** 7.08 m

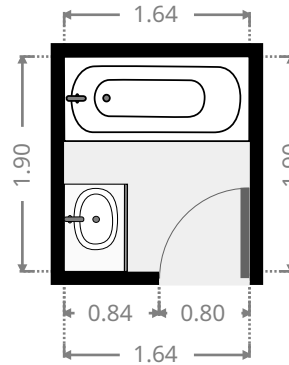
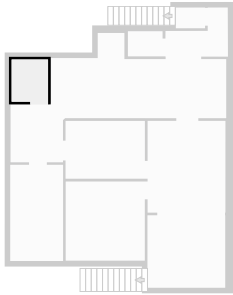

▼ **Bedroom**  
1st Floor

**WIDTH:** 2.38 m • **LENGTH:** 4.33 m  
**AREA:** 10.30 m<sup>2</sup> • **PERIMETER:** 13.42 m

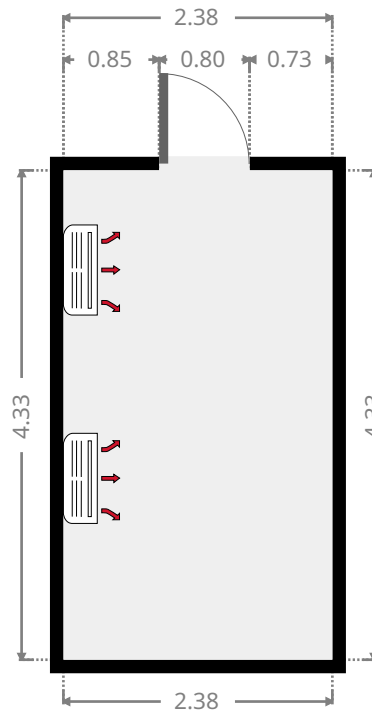
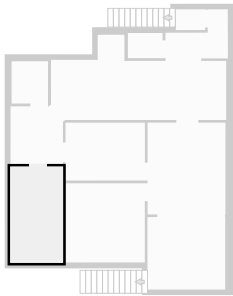

▼ Other  
1st Floor

WIDTH: 1.32 m • LENGTH: 0.93 m  
AREA: 1.22 m<sup>2</sup> • PERIMETER: 4.49 m

