

# 32 Constance Avenue

Created on  
2020-07-21

Floors  
1

## ▼ Ground Floor



THIS FLOORPLAN IS PROVIDED WITHOUT WARRANTY OF ANY KIND. SENSOPIA DISCLAIMS ANY WARRANTY INCLUDING, WITHOUT LIMITATION, SATISFACTORY QUALITY OR ACCURACY OF DIMENSIONS.

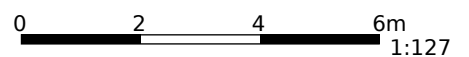

FLOORS: 1

▼ **Garage**  
Ground Floor

WIDTH: 9.00 m • LENGTH: 6.00 m  
AREA: 54.00 m<sup>2</sup> • PERIMETER: 30.00 m

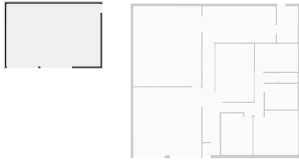

▼ **Garage**  
Ground Floor

WIDTH: 6.50 m • LENGTH: 6.53 m  
AREA: 42.44 m<sup>2</sup> • PERIMETER: 26.06 m

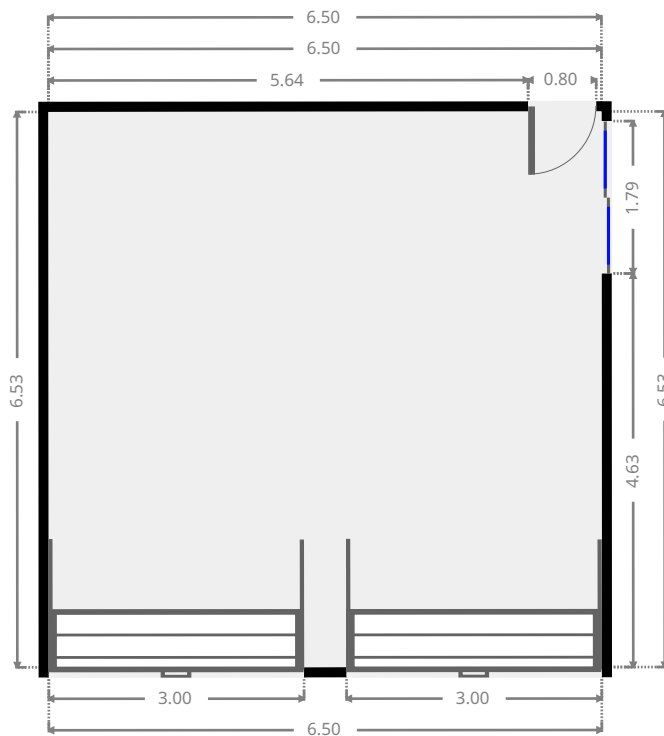
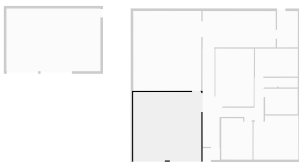

FLOORS: 1

## ▼ Hall Ground Floor

WIDTH: 4.87 m • LENGTH: 9.40 m  
AREA: 16.12 m<sup>2</sup> • PERIMETER: 28.67 m

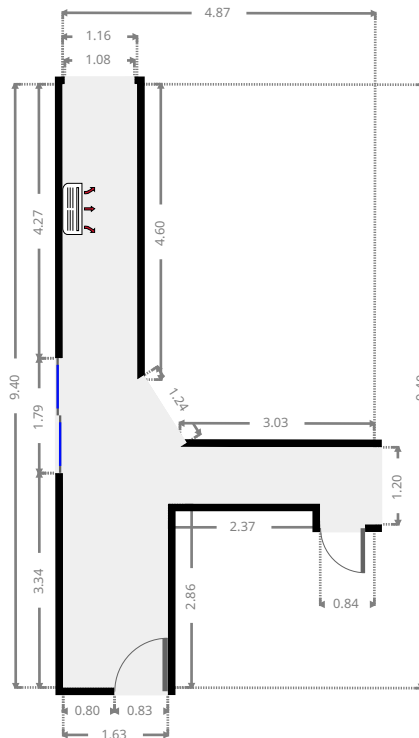
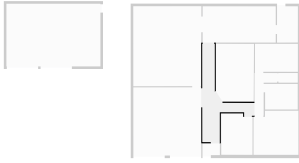

## ▼ Hall Ground Floor

WIDTH: 2.17 m • LENGTH: 4.08 m  
AREA: 4.77 m<sup>2</sup> • PERIMETER: 12.50 m

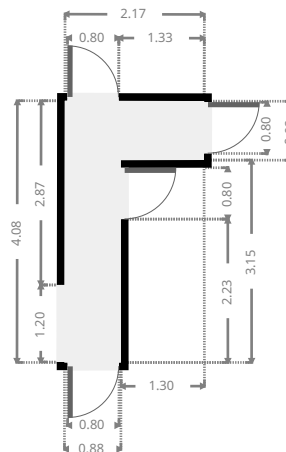
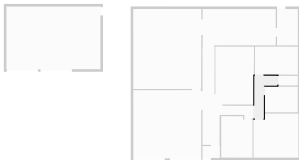

THIS FLOORPLAN IS PROVIDED WITHOUT WARRANTY OF ANY KIND. SENSOPIA DISCLAIMS ANY WARRANTY INCLUDING, WITHOUT LIMITATION, SATISFACTORY QUALITY OR ACCURACY OF DIMENSIONS.

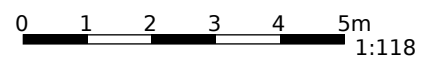

▼ **Bedroom**  
Ground Floor

WIDTH: 3.00 m • LENGTH: 3.97 m  
AREA: 11.57 m<sup>2</sup> • PERIMETER: 13.92 m

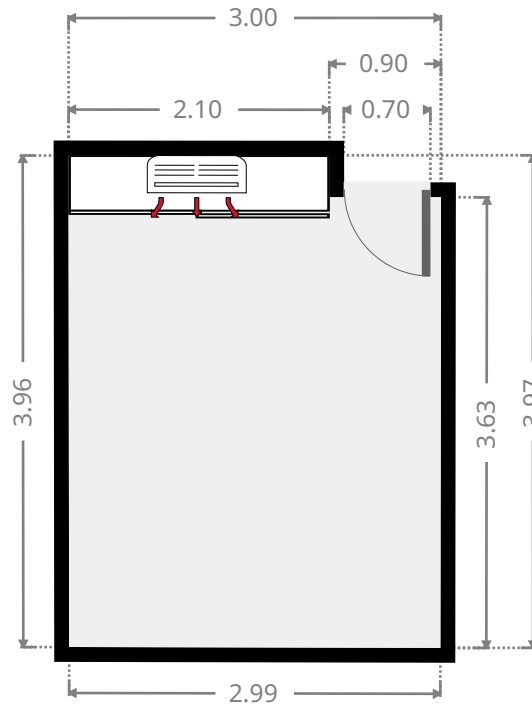
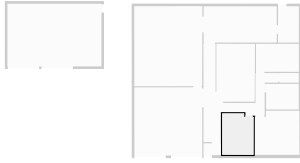

▼ **Master Bedroom**  
Ground Floor

WIDTH: 4.30 m • LENGTH: 4.22 m  
AREA: 17.49 m<sup>2</sup> • PERIMETER: 17.03 m

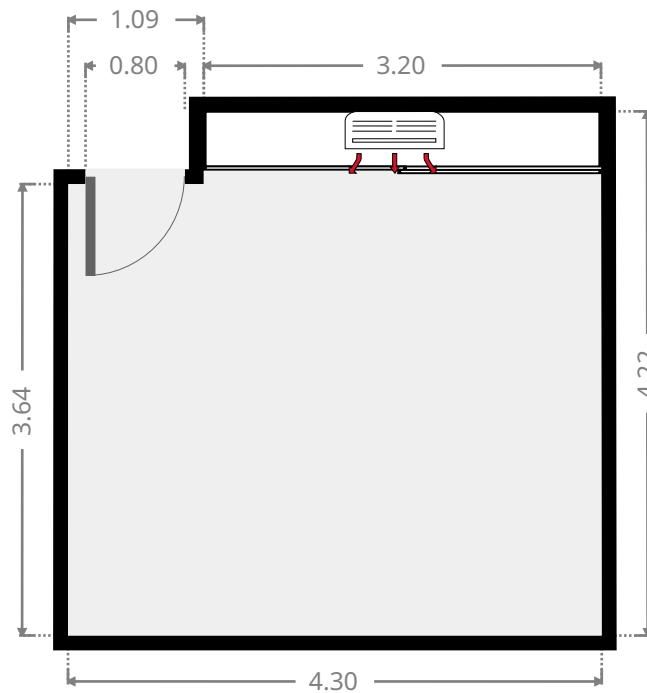
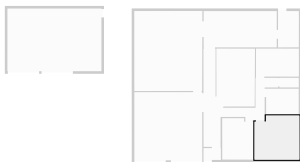

FLOORS: 1

▼ **Bathroom**  
Ground Floor

WIDTH: 3.12 m • LENGTH: 2.45 m  
AREA: 7.65 m<sup>2</sup> • PERIMETER: 11.14 m

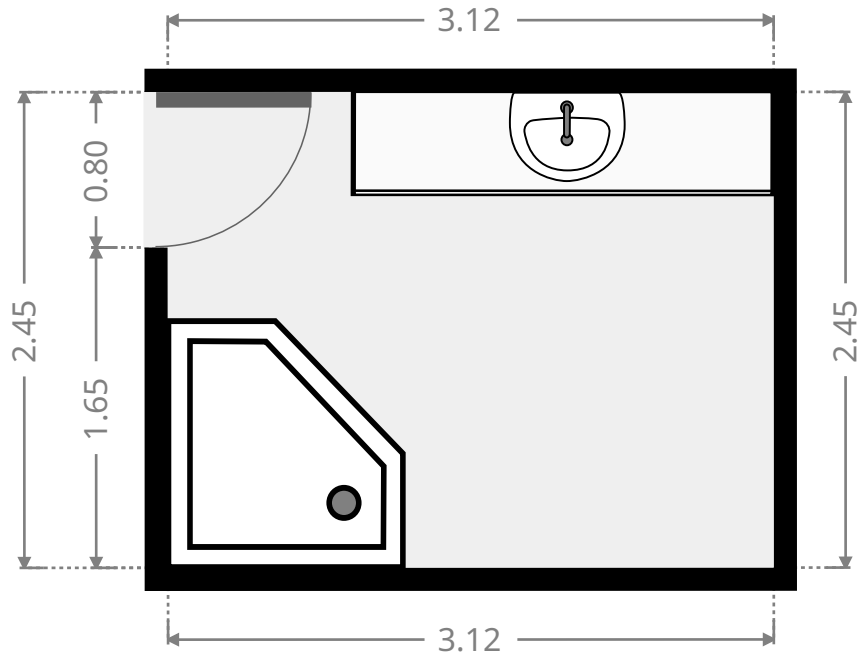

▼ **Toilet**  
Ground Floor

WIDTH: 1.85 m • LENGTH: 0.93 m  
AREA: 1.71 m<sup>2</sup> • PERIMETER: 5.55 m

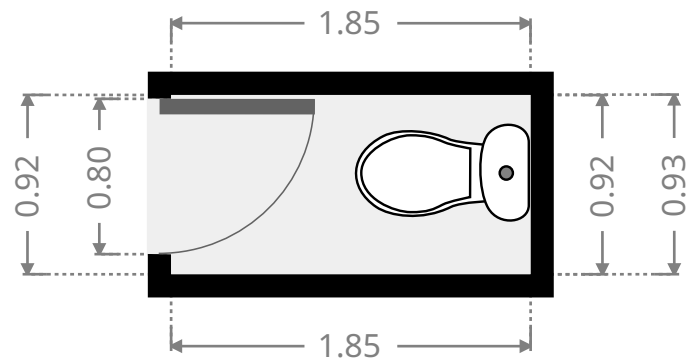
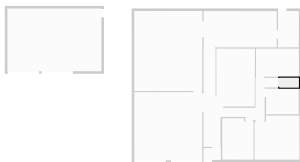

FLOORS: 1

## ▼ Bedroom Ground Floor

WIDTH: 4.11 m • LENGTH: 2.68 m  
AREA: 11.01 m<sup>2</sup> • PERIMETER: 13.58 m

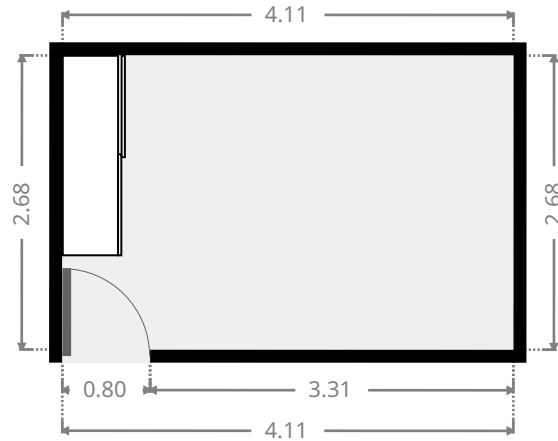
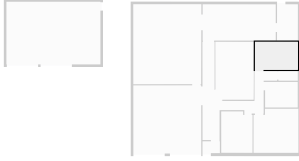

## ▼ Living Room Ground Floor

WIDTH: 3.70 m • LENGTH: 5.55 m  
AREA: 20.09 m<sup>2</sup> • PERIMETER: 17.99 m

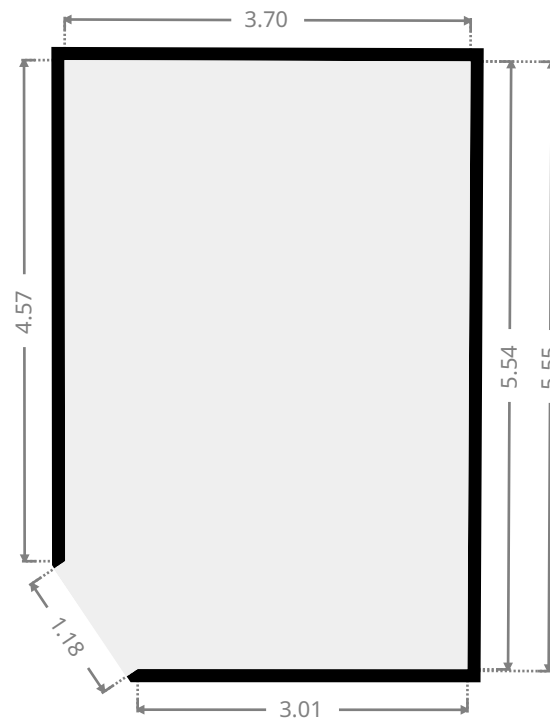
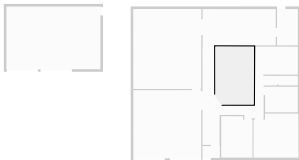

FLOORS: 1

## ▼ Kitchen Ground Floor

WIDTH: 7.00 m • LENGTH: 3.47 m  
AREA: 24.30 m<sup>2</sup> • PERIMETER: 20.94 m

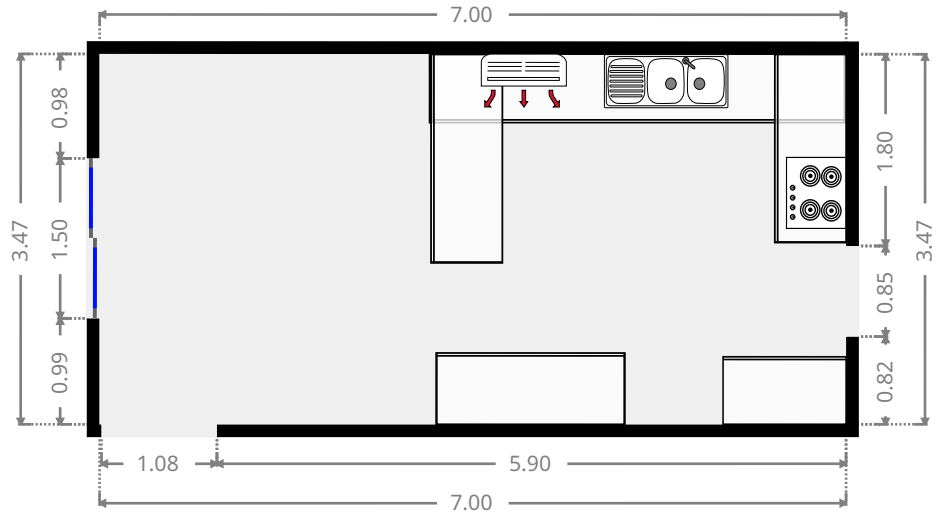
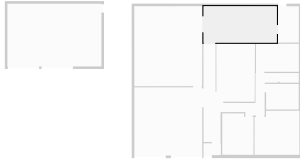

## ▼ Laundry Room Ground Floor

WIDTH: 1.99 m • LENGTH: 3.48 m  
AREA: 6.93 m<sup>2</sup> • PERIMETER: 10.94 m

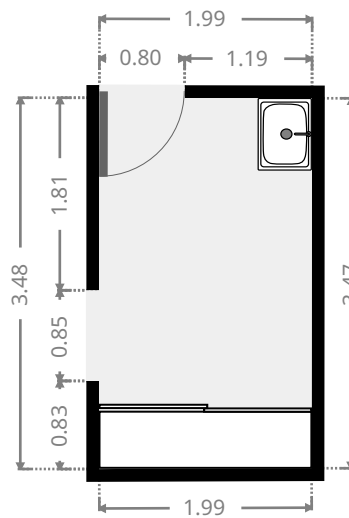



FLOORS: 1

## ▼ Other Ground Floor

WIDTH: 6.53 m • LENGTH: 7.66 m  
AREA: 49.87 m<sup>2</sup> • PERIMETER: 28.34 m

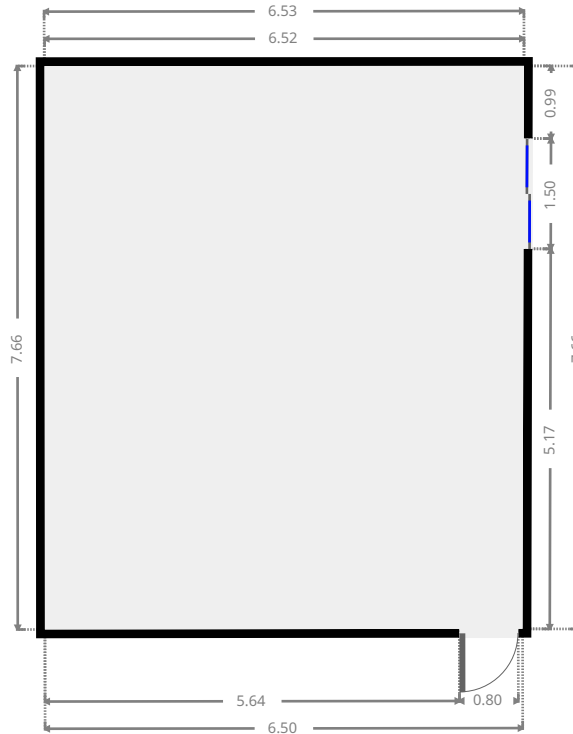
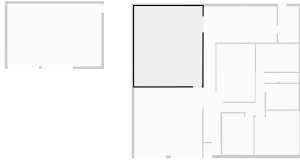

## ▼ Other Ground Floor

WIDTH: 1.66 m • LENGTH: 1.13 m  
AREA: 1.88 m<sup>2</sup> • PERIMETER: 5.59 m

