

316 Mills Avenue

Created on
2021-02-02

Floors
2

▼ Ground Floor

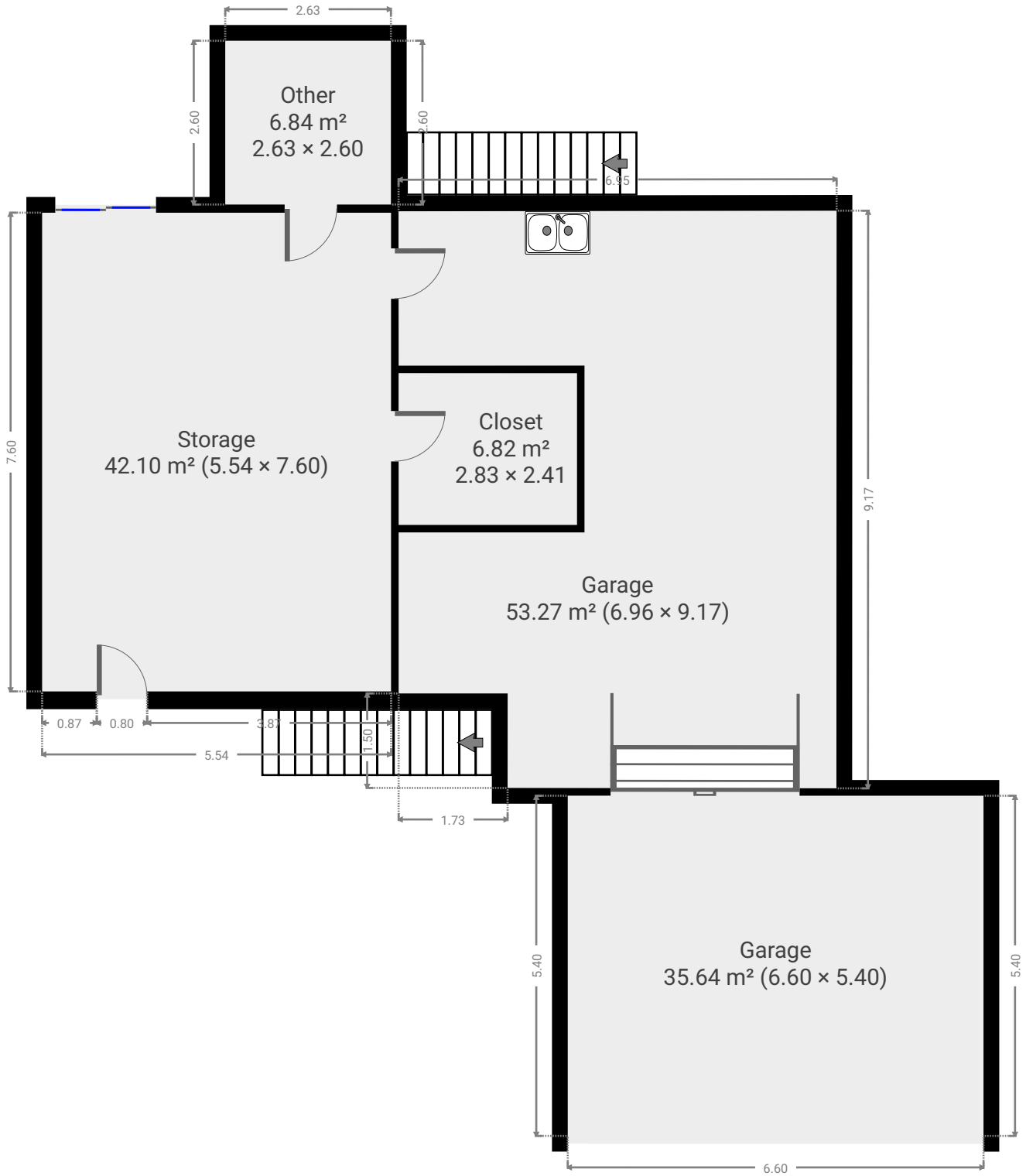

▼ Storage
Ground Floor

WIDTH: 5.54 m • LENGTH: 7.60 m
AREA: 42.10 m² • PERIMETER: 26.28 m

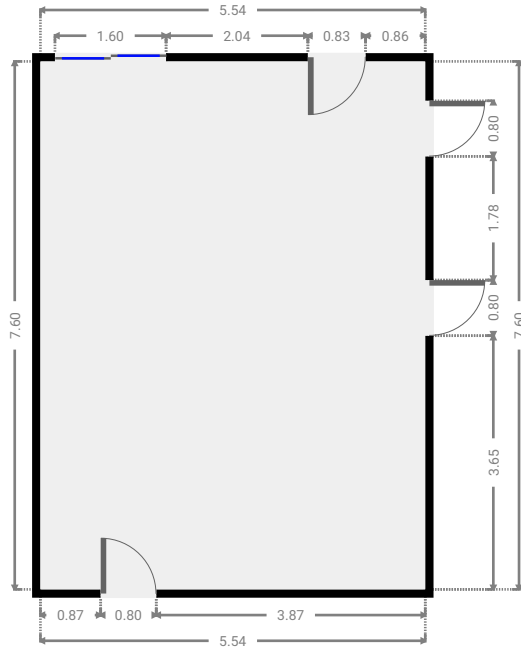
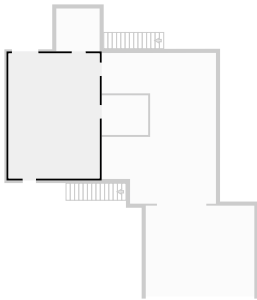

▼ Garage
Ground Floor

WIDTH: 6.96 m • LENGTH: 9.17 m
AREA: 53.27 m² • PERIMETER: 38.13 m

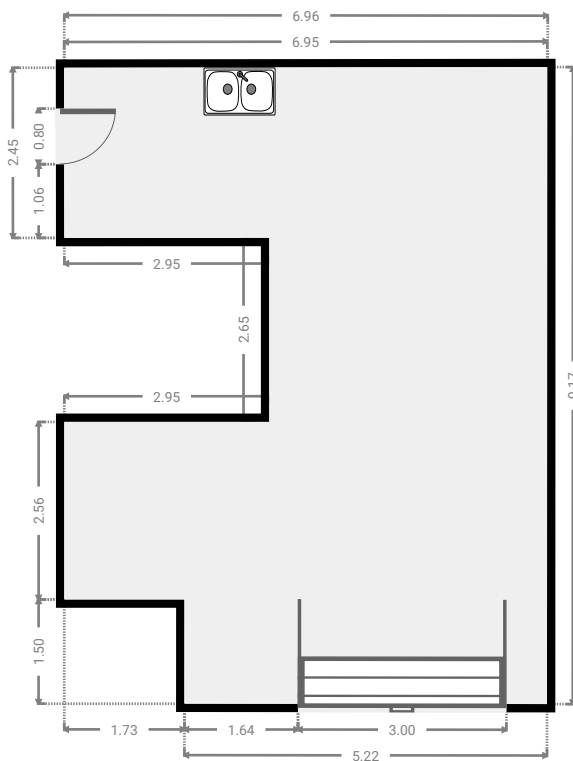
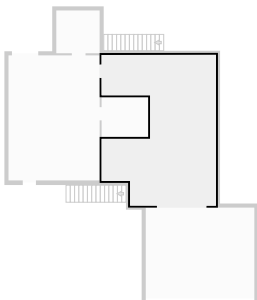

▼ Other
Ground Floor

WIDTH: 2.63 m • LENGTH: 2.60 m
AREA: 6.84 m² • PERIMETER: 10.46 m

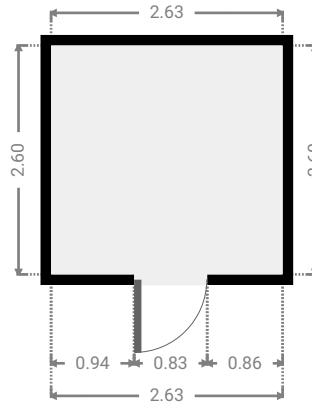
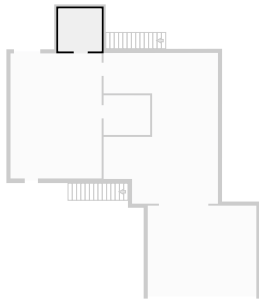

▼ Garage
Ground Floor

WIDTH: 6.60 m • LENGTH: 5.40 m
AREA: 35.64 m² • PERIMETER: 24.00 m

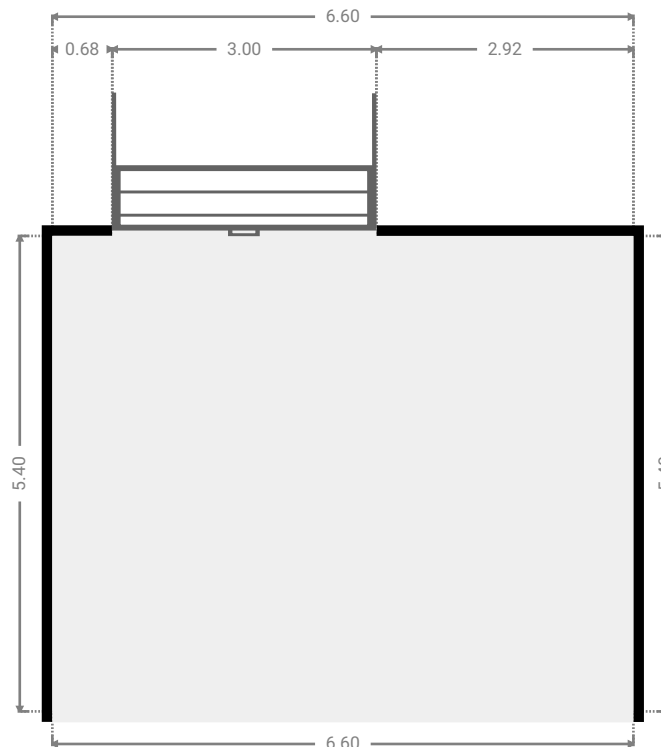
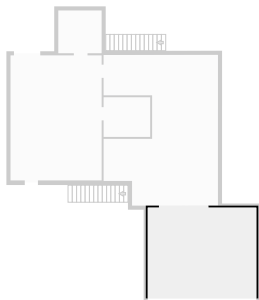

▼ Closet
Ground Floor

WIDTH: 2.83 m • LENGTH: 2.41 m
AREA: 6.82 m² • PERIMETER: 10.48 m

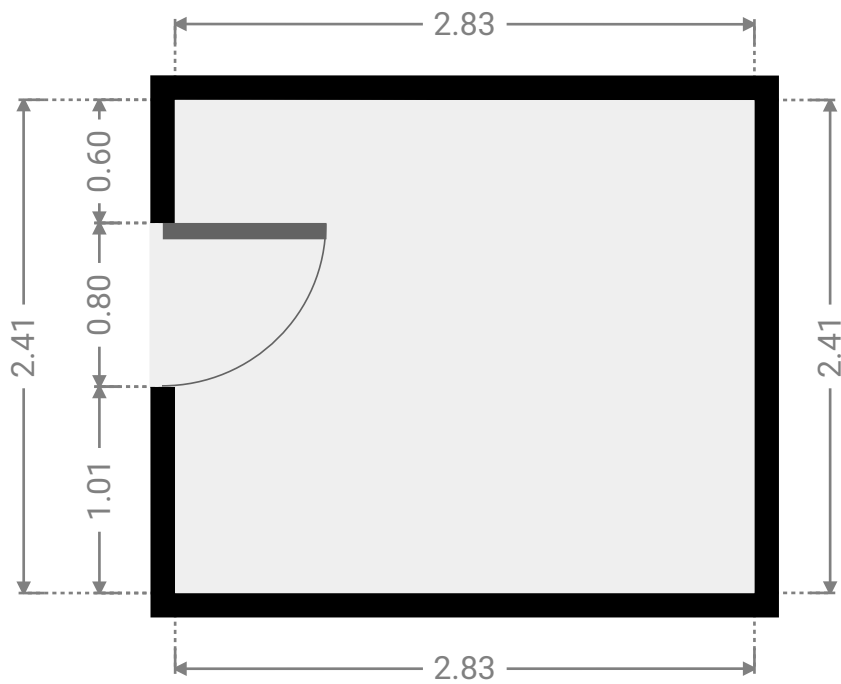
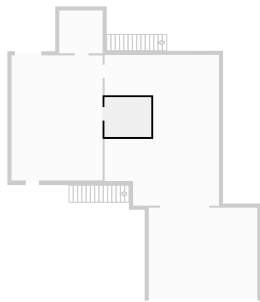

▼ 1st Floor

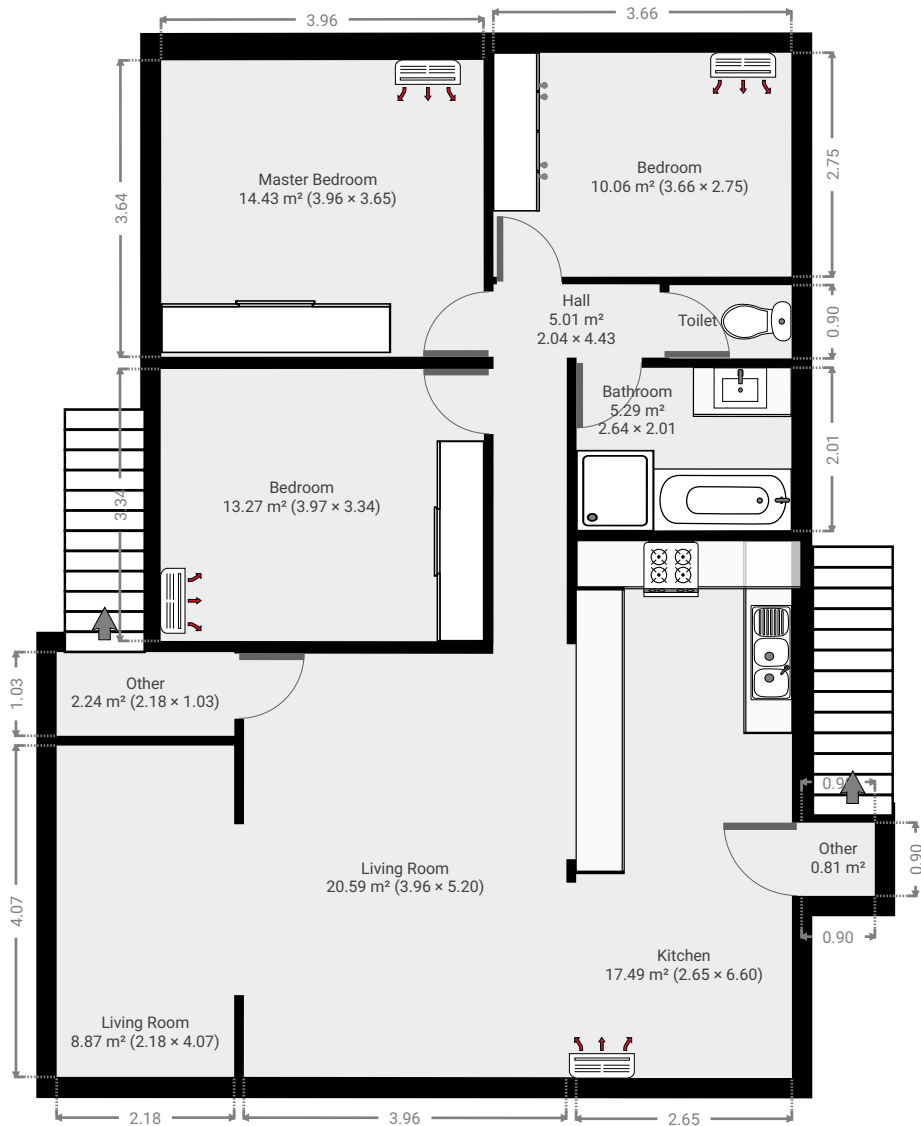

▼ Living Room
1st Floor

WIDTH: 4.07 m • LENGTH: 2.18 m
AREA: 8.87 m² • PERIMETER: 12.50 m

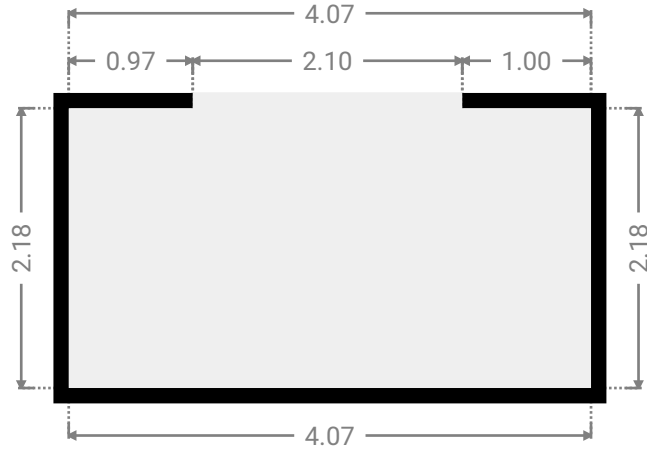
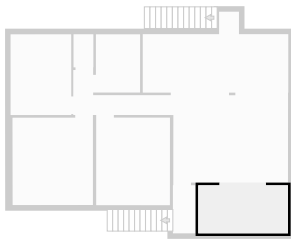

▼ Living Room
1st Floor

WIDTH: 5.20 m • LENGTH: 3.96 m
AREA: 20.59 m² • PERIMETER: 18.32 m

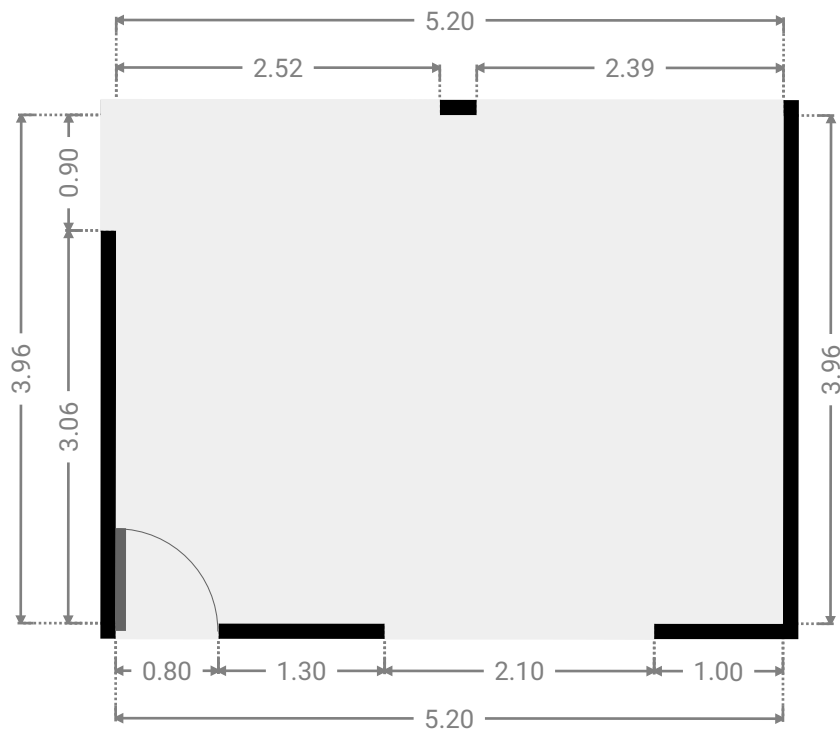
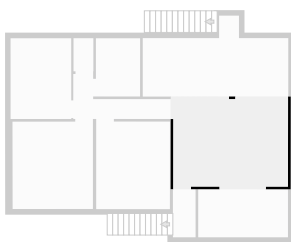

▼ Kitchen
1st Floor

WIDTH: 6.60 m • LENGTH: 2.65 m
AREA: 17.49 m² • PERIMETER: 18.50 m

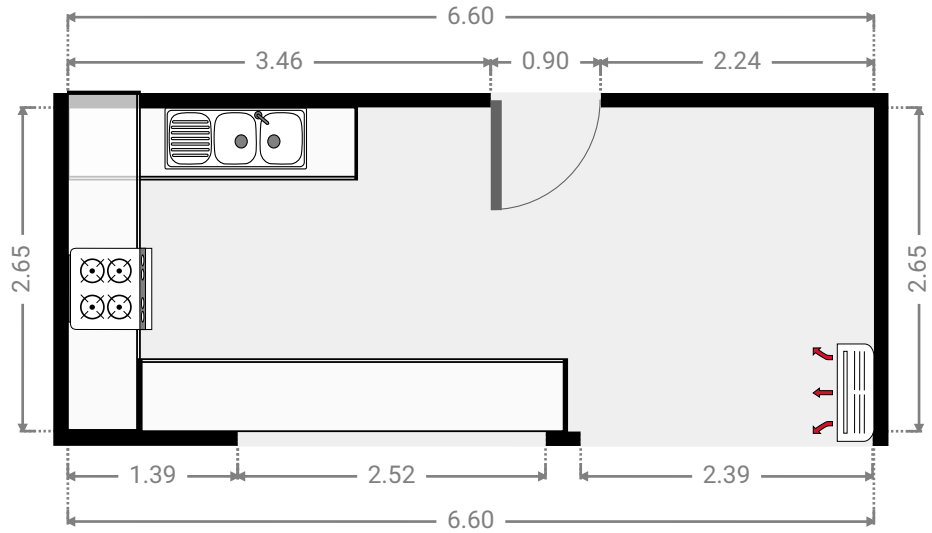
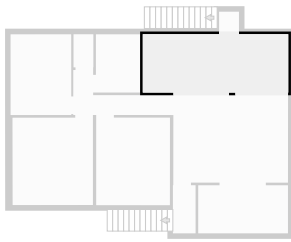

▼ Other
1st Floor

WIDTH: 0.90 m • LENGTH: 0.90 m
AREA: 0.81 m² • PERIMETER: 3.60 m

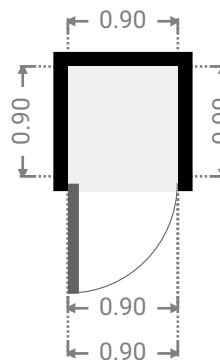
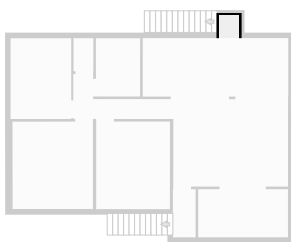

▼ Hall
1st Floor

WIDTH: 4.43 m • LENGTH: 2.04 m
AREA: 5.01 m² • PERIMETER: 12.94 m

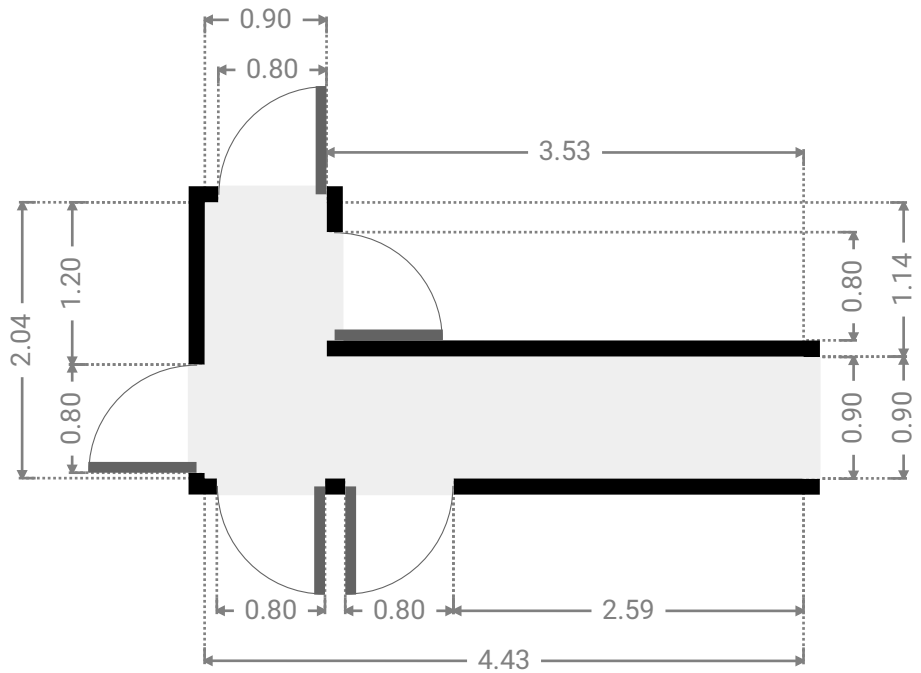
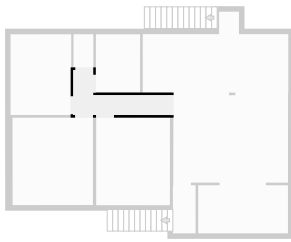

▼ Toilet
1st Floor

WIDTH: 0.90 m • LENGTH: 1.50 m
AREA: 1.35 m² • PERIMETER: 4.80 m

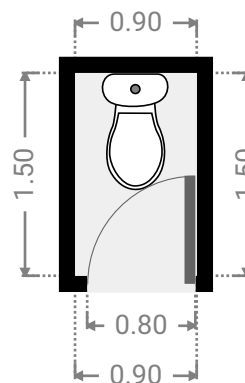
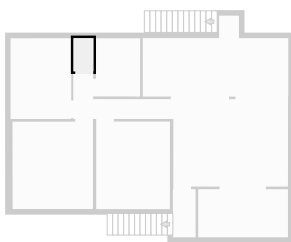

▼ Bathroom
1st Floor

WIDTH: 2.01 m • LENGTH: 2.64 m
AREA: 5.29 m² • PERIMETER: 9.28 m

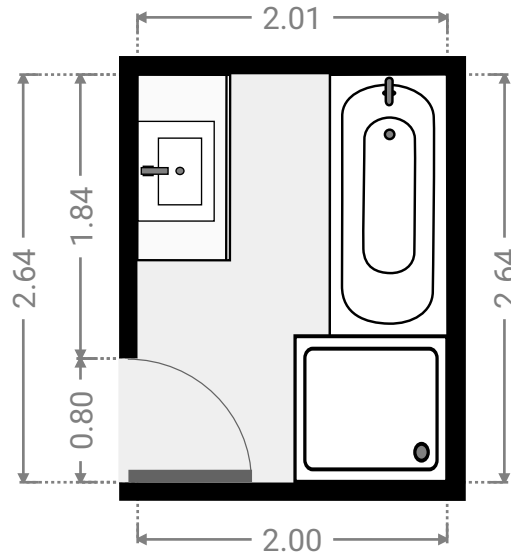
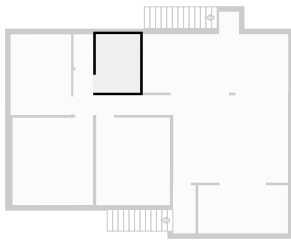

▼ Bedroom
1st Floor

WIDTH: 2.75 m • LENGTH: 3.66 m
AREA: 10.06 m² • PERIMETER: 12.82 m

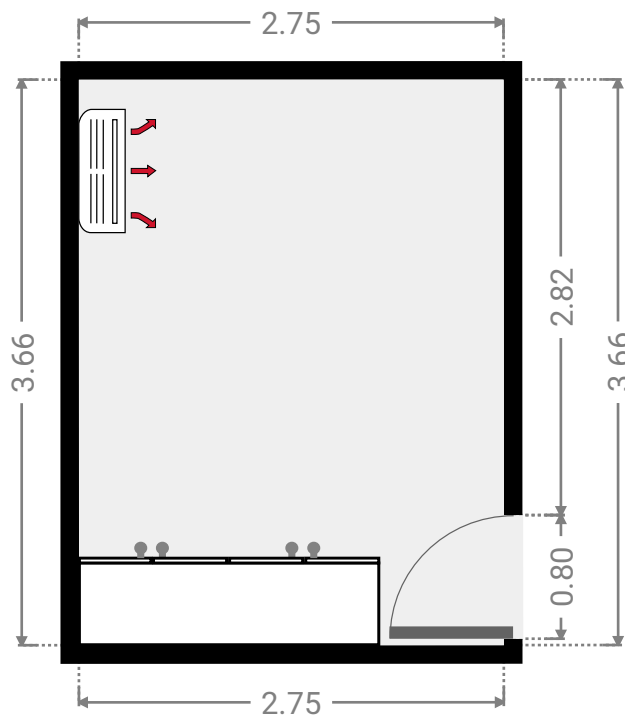
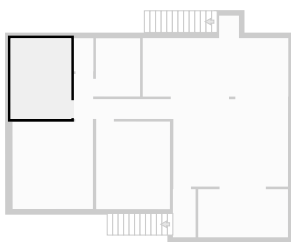

▼ **Master Bedroom**
1st Floor

WIDTH: 3.65 m • LENGTH: 3.96 m
AREA: 14.43 m² • PERIMETER: 15.21 m

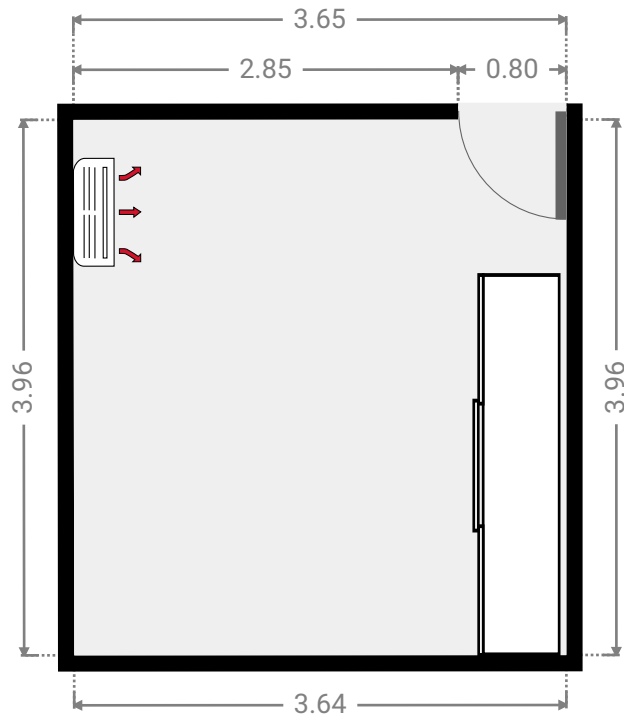
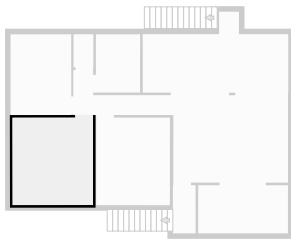

▼ **Bedroom**
1st Floor

WIDTH: 3.34 m • LENGTH: 3.97 m
AREA: 13.27 m² • PERIMETER: 14.62 m

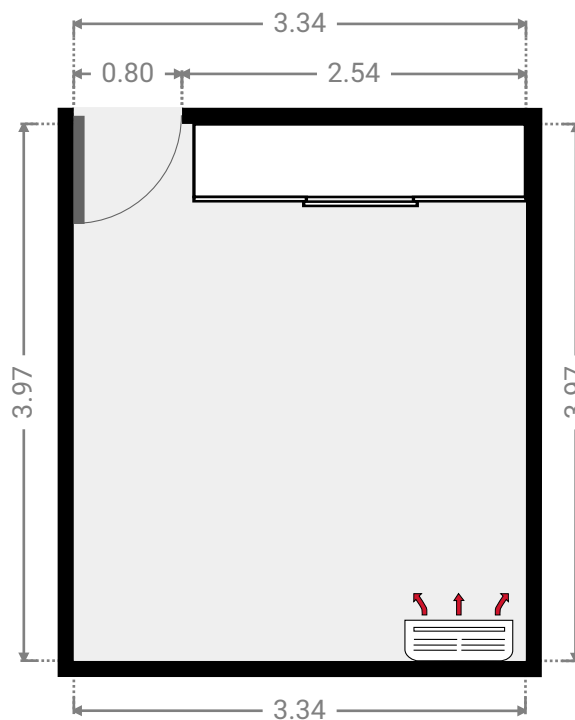
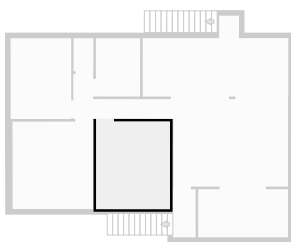

▼ Other
1st Floor

WIDTH: 1.03 m • LENGTH: 2.18 m
AREA: 2.24 m² • PERIMETER: 6.42 m

