

311 Mills Avenue , Frenchville

Ground Floor

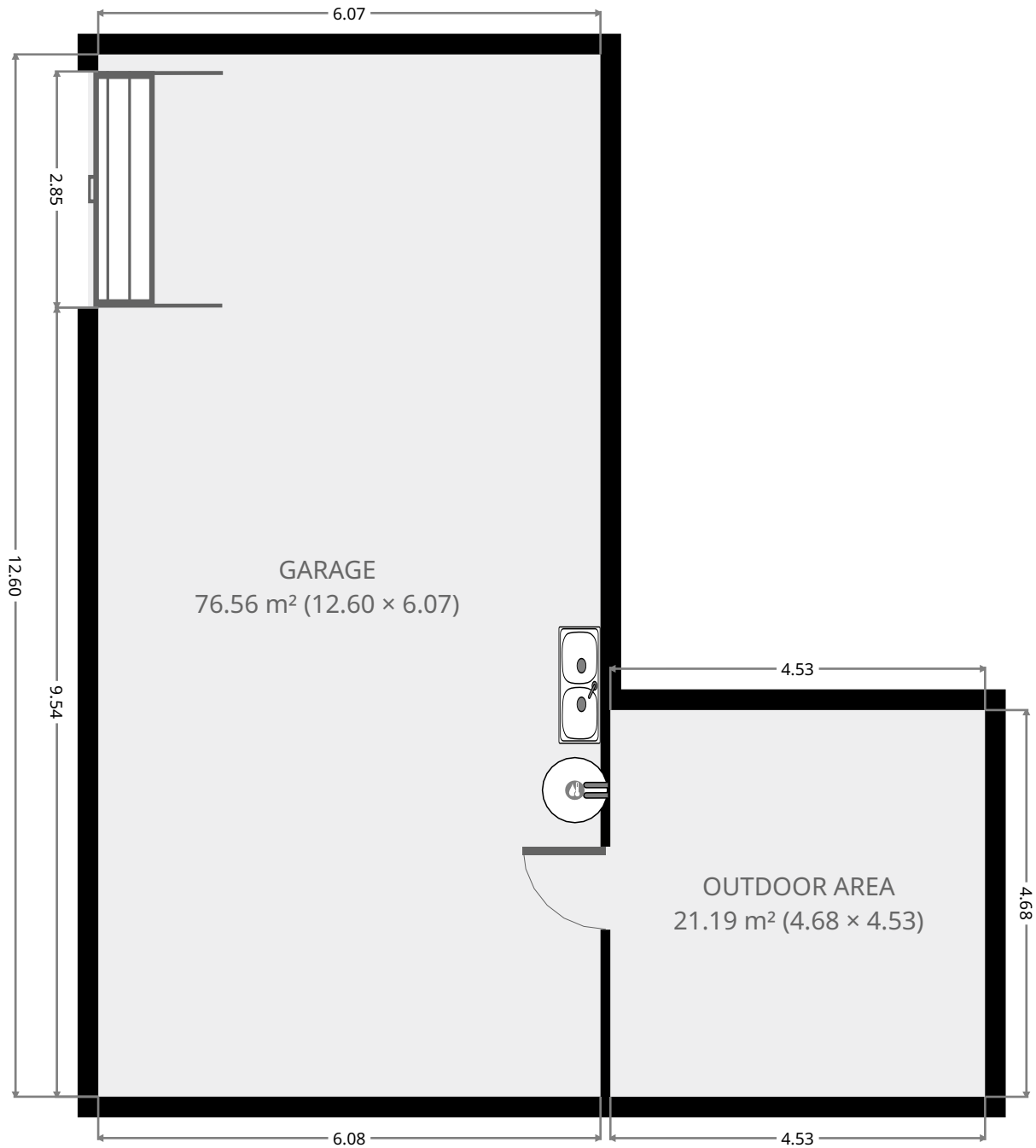

THIS FLOORPLAN IS PROVIDED WITHOUT WARRANTY OF ANY KIND. SENSOPIA DISCLAIMS ANY WARRANTY INCLUDING, WITHOUT LIMITATION, SATISFACTORY QUALITY OR ACCURACY OF DIMENSIONS.



311 Mills Avenue , Frenchville

Garage

Width: 6.07 m
Length: 12.60 m
Area: 76.56 m²
Perimeter: 37.36 m

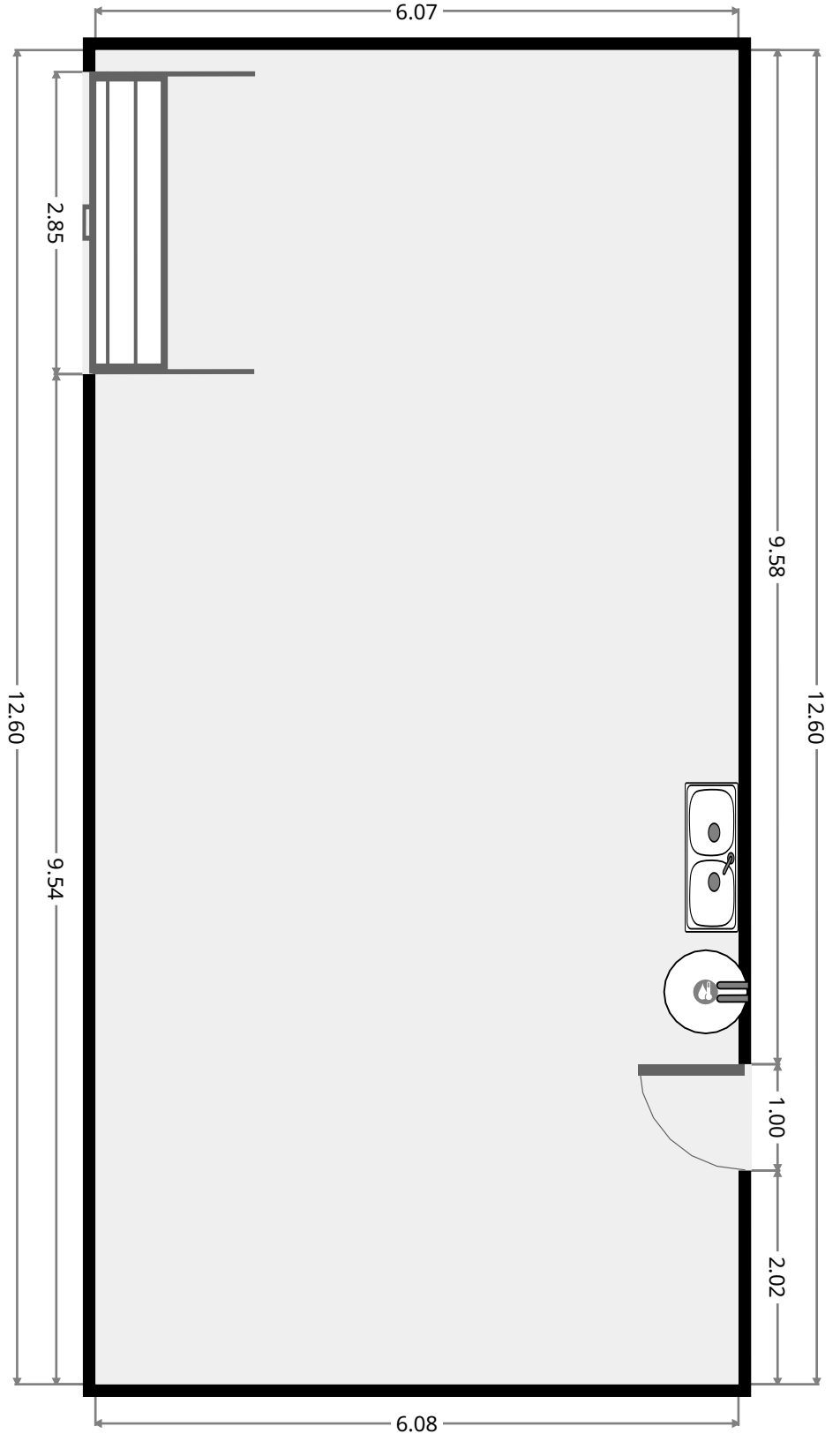
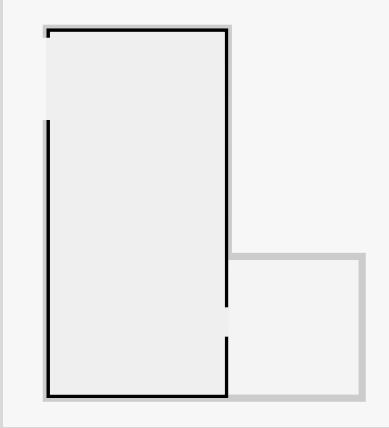

THIS FLOORPLAN IS PROVIDED WITHOUT WARRANTY OF ANY KIND. SENSOPIA DISCLAIMS ANY WARRANTY INCLUDING, WITHOUT LIMITATION, SATISFACTORY QUALITY OR ACCURACY OF DIMENSIONS.

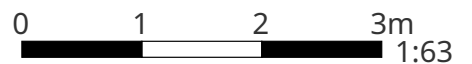

311 Mills Avenue , Frenchville

Outdoor Area

Width: 4.53 m
Length: 4.68 m
Area: 21.19 m²
Perimeter: 18.42 m

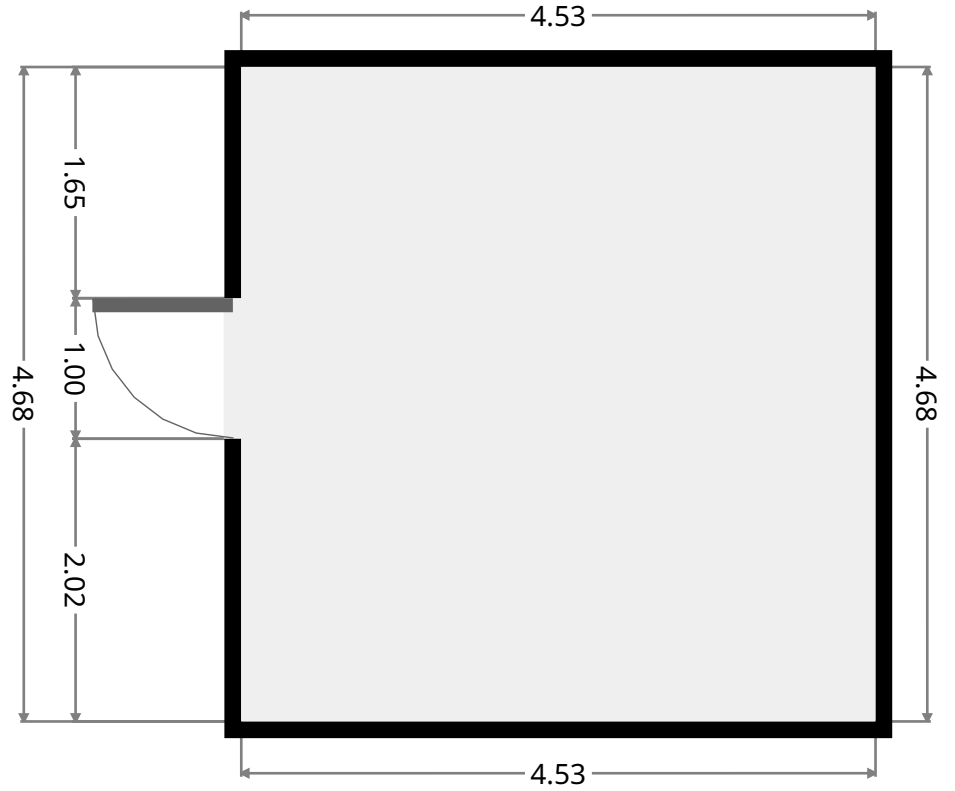
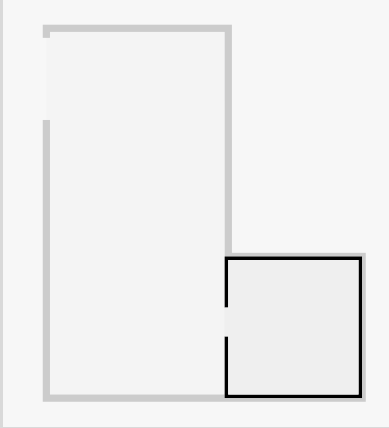

311 Mills Avenue , Frenchville

1st Floor

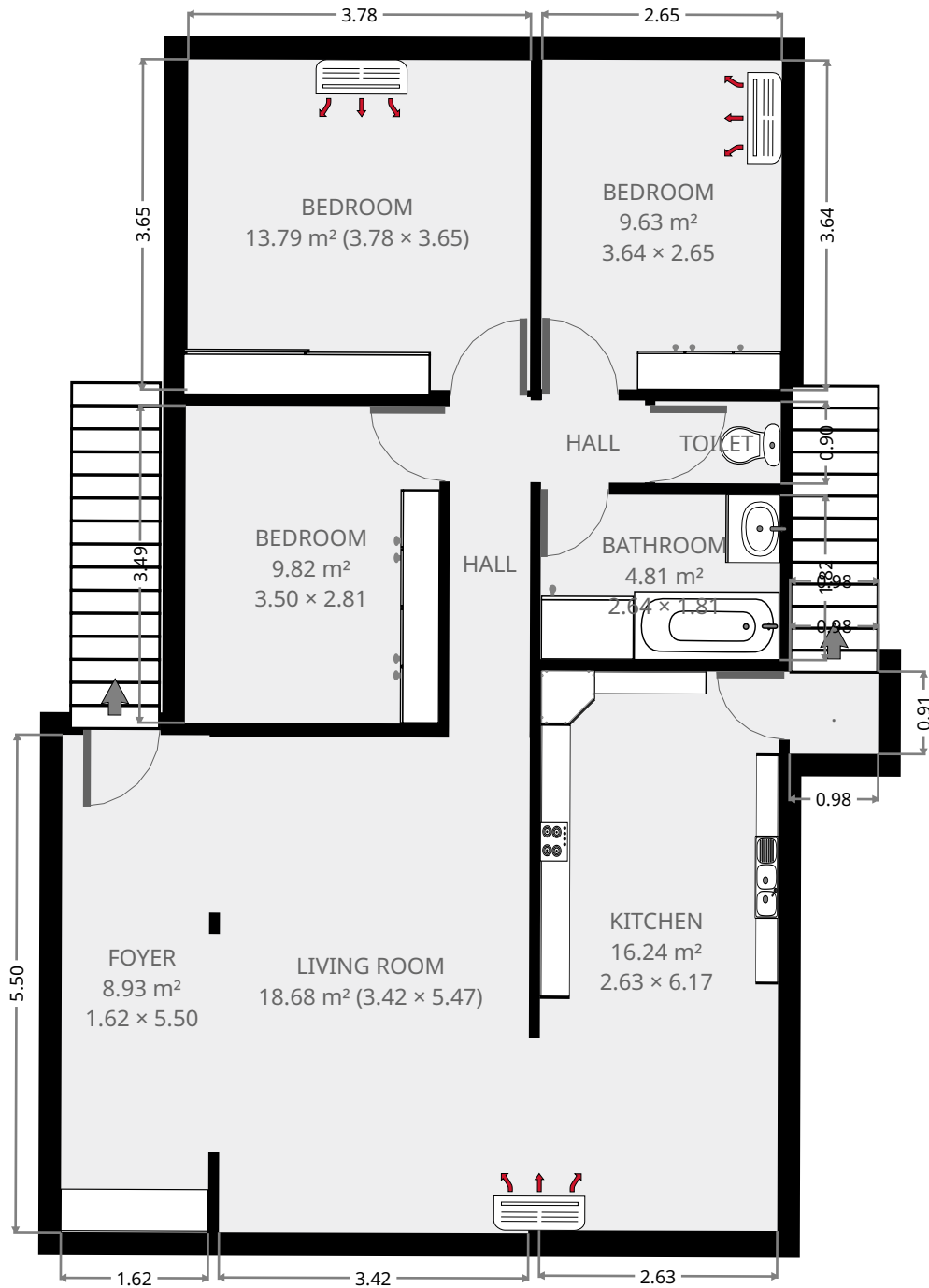

THIS FLOORPLAN IS PROVIDED WITHOUT WARRANTY OF ANY KIND. SENSOPIA DISCLAIMS ANY WARRANTY INCLUDING, WITHOUT LIMITATION, SATISFACTORY QUALITY OR ACCURACY OF DIMENSIONS.



311 Mills Avenue , Frenchville

Foyer

Width: 1.62 m
 Length: 5.50 m
 Area: 8.93 m²
 Perimeter: 14.24 m

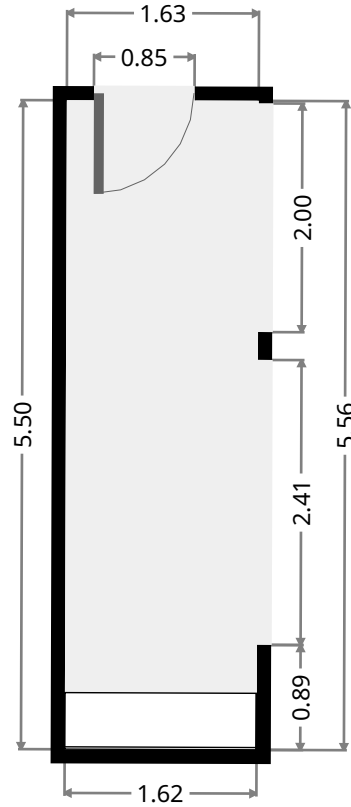
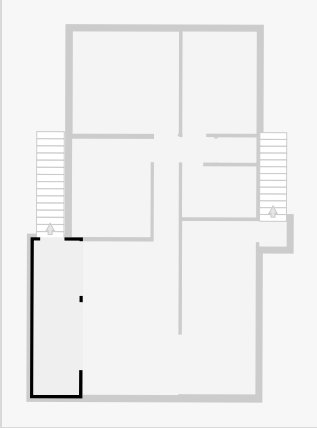

Living Room

Width: 3.42 m
 Length: 5.47 m
 Area: 18.68 m²
 Perimeter: 17.77 m

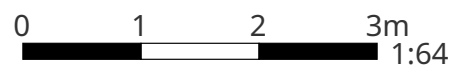
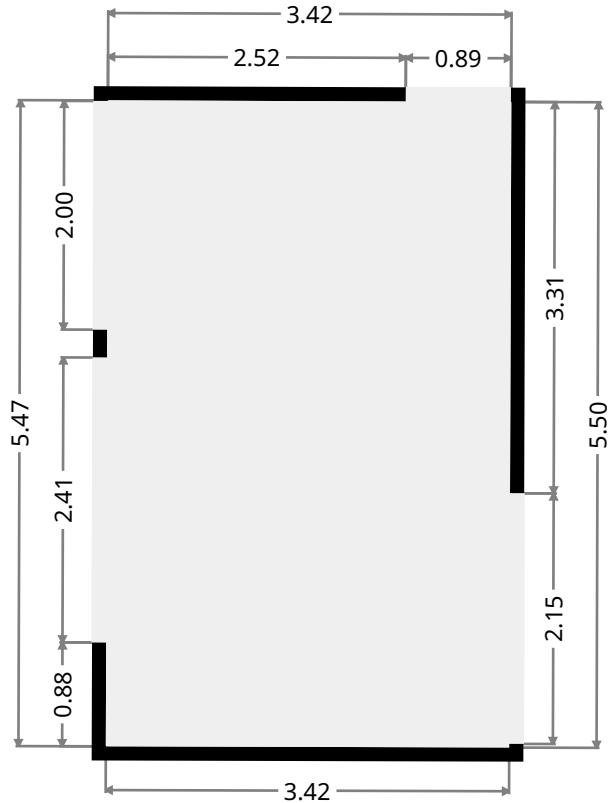
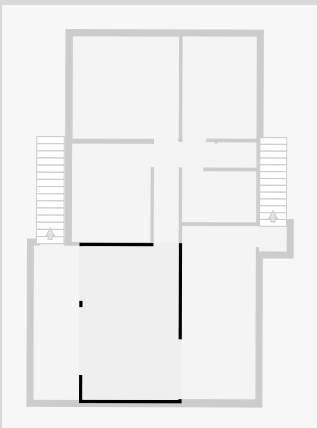

THIS FLOORPLAN IS PROVIDED WITHOUT WARRANTY OF ANY KIND. SENSOPIA DISCLAIMS ANY WARRANTY INCLUDING, WITHOUT LIMITATION, SATISFACTORY QUALITY OR ACCURACY OF DIMENSIONS.

311 Mills Avenue , Frenchville

Kitchen

Width: 2.63 m
 Length: 6.17 m
 Area: 16.24 m²
 Perimeter: 17.61 m

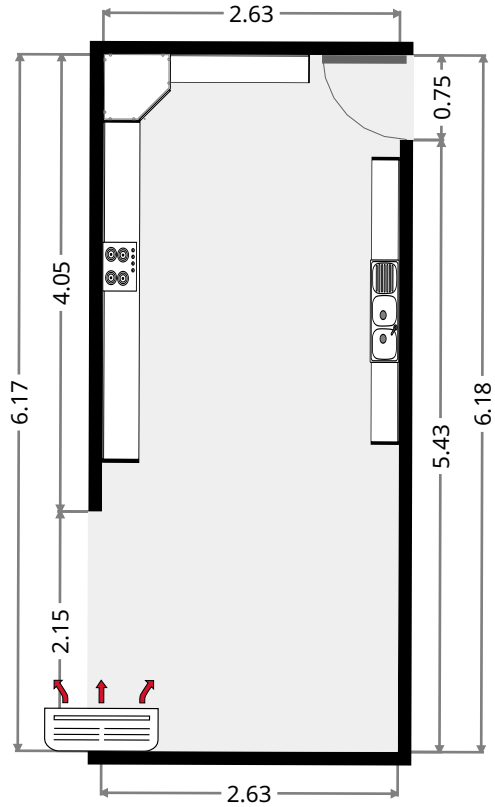
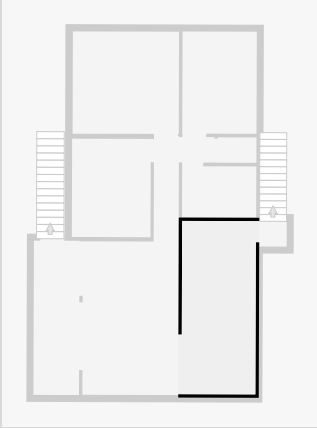

Hall

Width: 0.89 m
 Length: 3.69 m
 Area: 3.27 m²
 Perimeter: 9.14 m

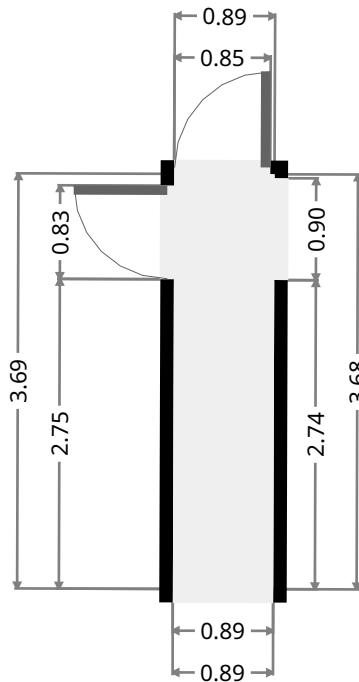
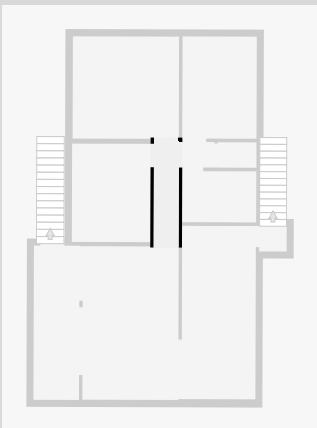

311 Mills Avenue , Frenchville

Bedroom

Width: 2.81 m
 Length: 3.50 m
 Area: 9.82 m²
 Perimeter: 12.61 m

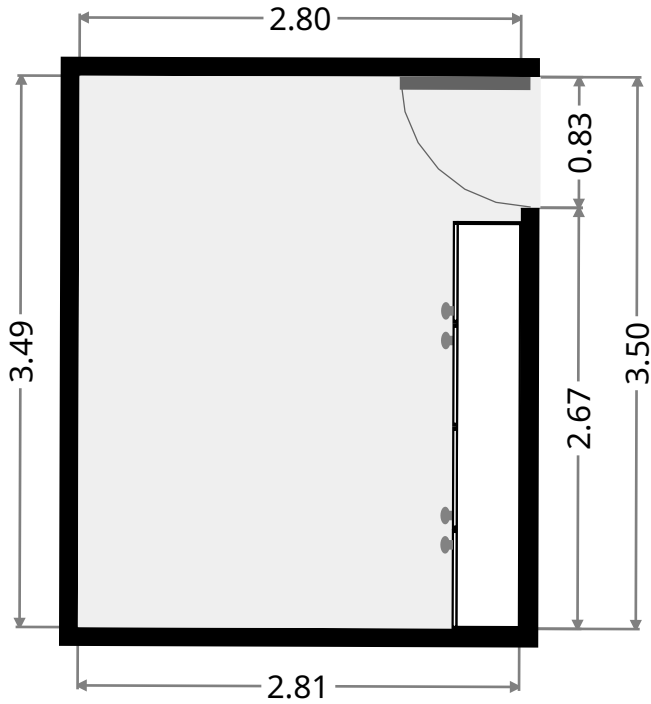
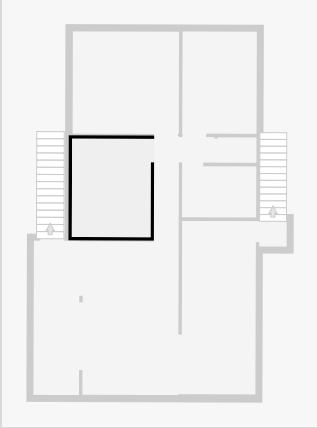

Bedroom

Width: 3.65 m
 Length: 3.78 m
 Area: 13.79 m²
 Perimeter: 14.86 m

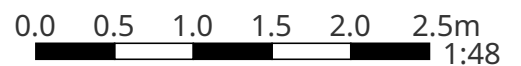
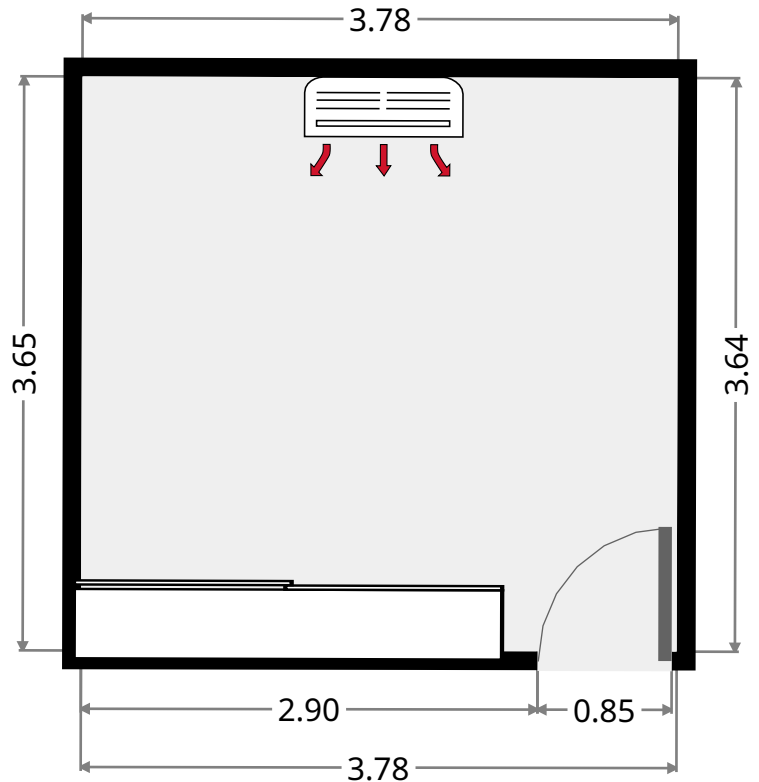
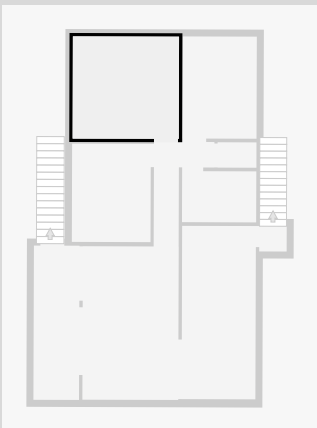

311 Mills Avenue , Frenchville

Hall

Width: 0.91 m
Length: 1.15 m
Area: 1.04 m²
Perimeter: 4.11 m

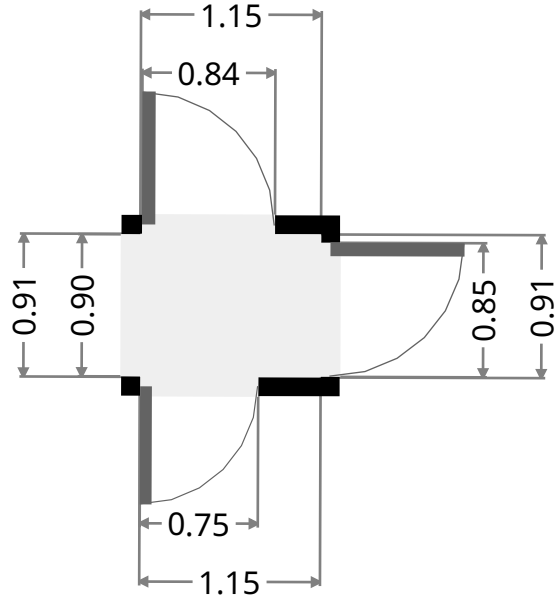
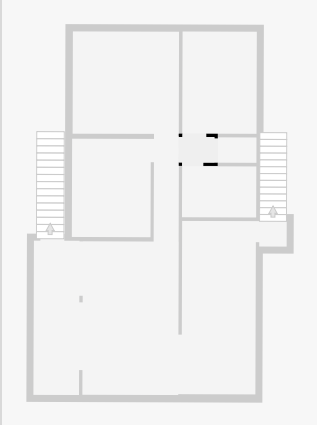

Bedroom

Width: 2.65 m
Length: 3.64 m
Area: 9.63 m²
Perimeter: 12.57 m

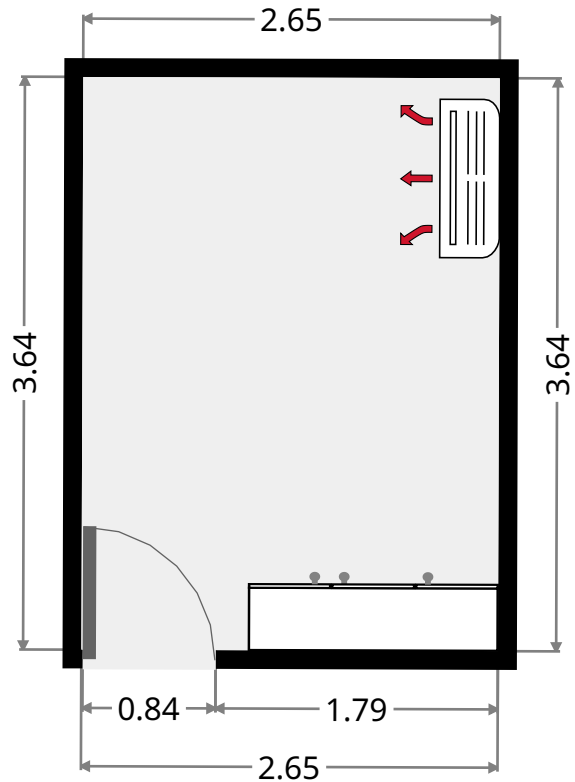
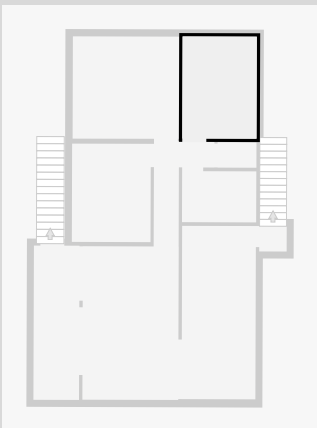

311 Mills Avenue , Frenchville

Toilet

Width: 0.90 m
Length: 1.39 m
Area: 1.25 m²
Perimeter: 4.58 m

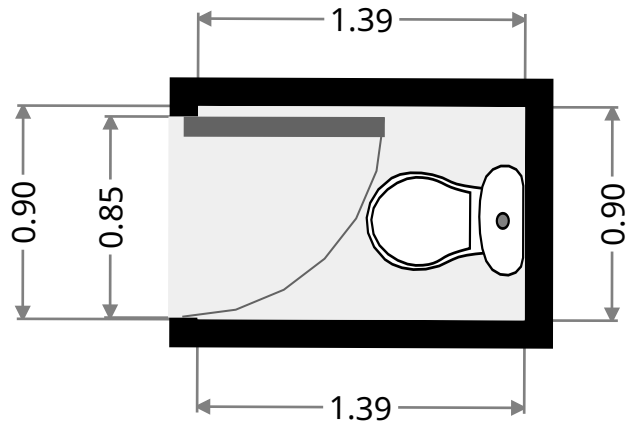
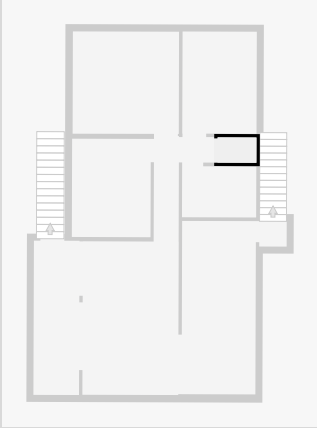

Bathroom

Width: 1.81 m
Length: 2.64 m
Area: 4.81 m²
Perimeter: 8.92 m

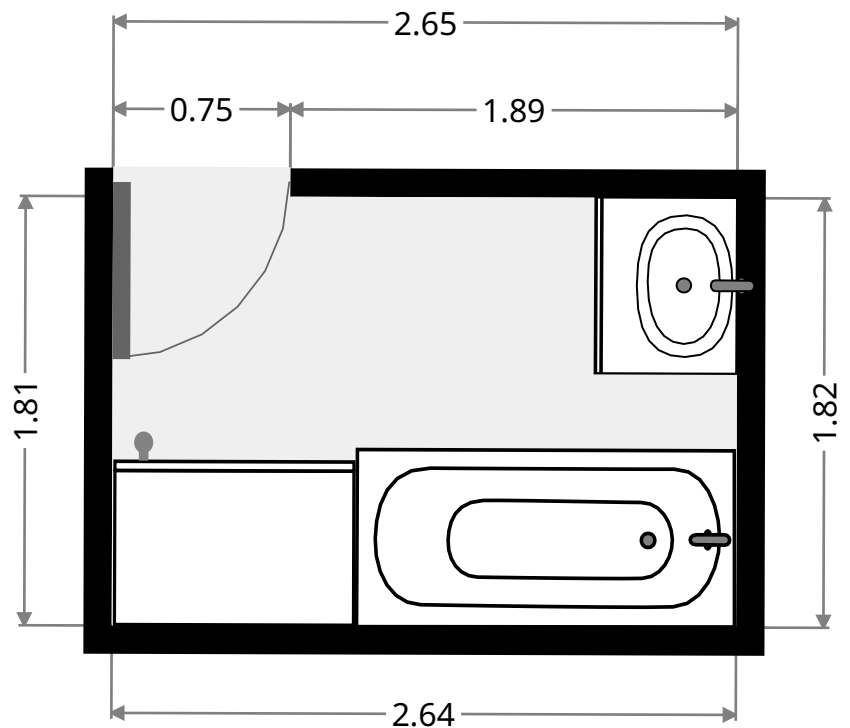
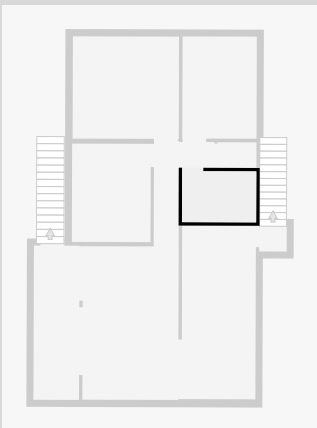

311 Mills Avenue , Frenchville

•
Width: 0.91 m
Length: 0.98 m
Area: 0.89 m²
Perimeter: 3.78 m

