

31 Van Haeren

Created on
2021-09-14

Floors
1

▼ Ground Floor



▼ **Hall**
Ground Floor

WIDTH: 1.04 m • LENGTH: 1.50 m
AREA: 1.56 m² • PERIMETER: 5.08 m

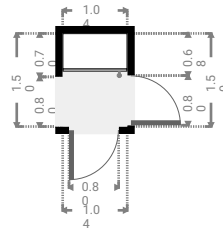
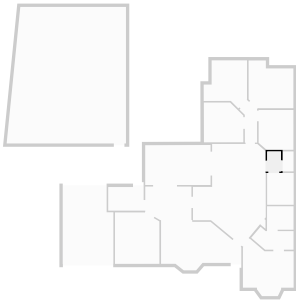

▼ **Pool**
Ground Floor

WIDTH: 9.00 m • LENGTH: 10.30 m
AREA: 87.39 m² • PERIMETER: 37.62 m

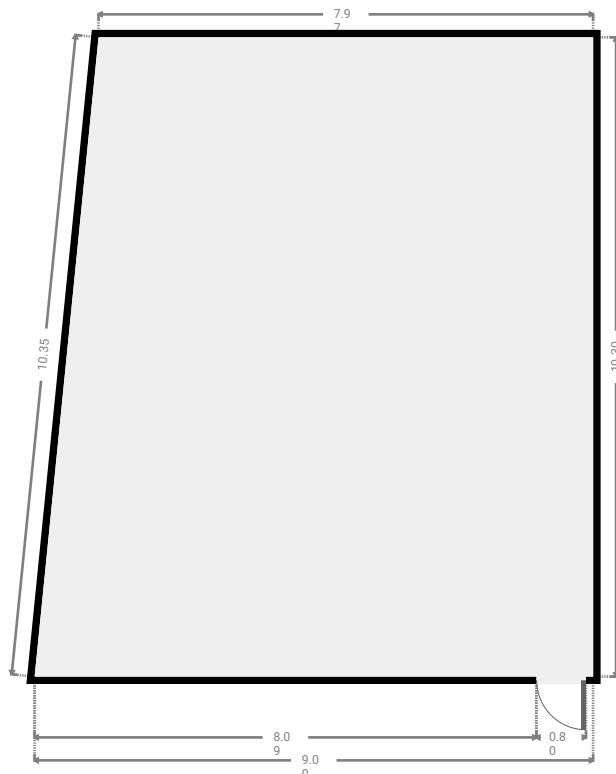
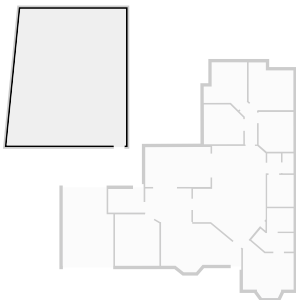

▼ Garage Ground Floor

WIDTH: 3.82 m • LENGTH: 5.81 m
AREA: 21.22 m² • PERIMETER: 19.26 m

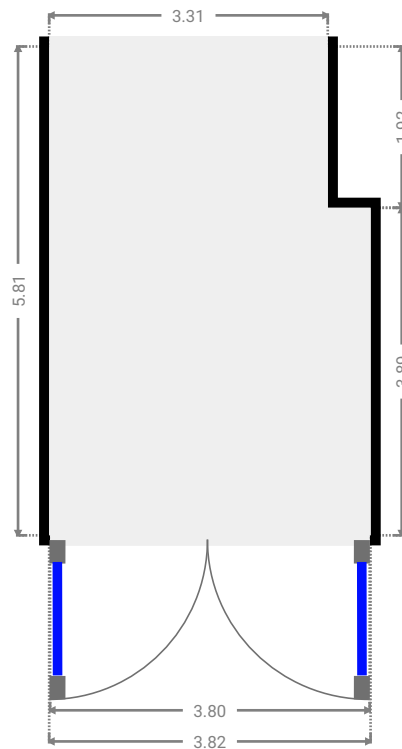
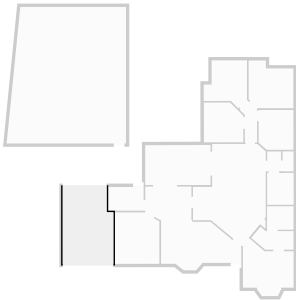

▼ Other Ground Floor

WIDTH: 4.93 m • LENGTH: 3.02 m
AREA: 14.83 m² • PERIMETER: 15.87 m

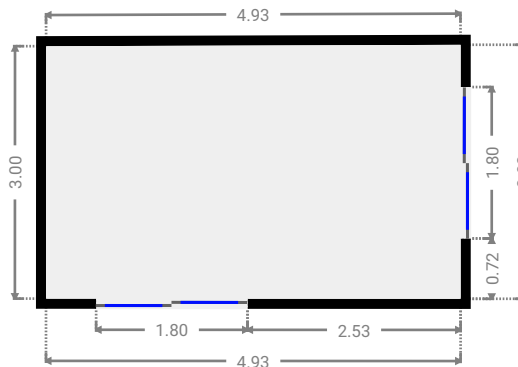
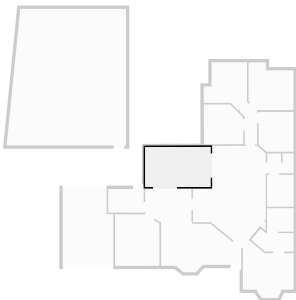

▼ Closet Ground Floor

WIDTH: 0.32 m • LENGTH: 0.66 m
AREA: 0.10 m² • PERIMETER: 1.58 m

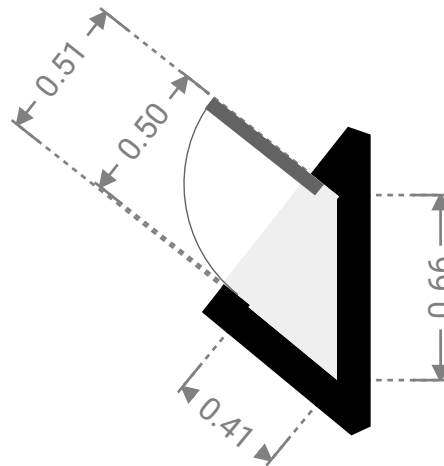
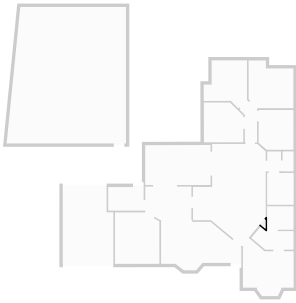

▼ Other Ground Floor

WIDTH: 1.82 m • LENGTH: 0.52 m
AREA: 0.78 m² • PERIMETER: 4.23 m

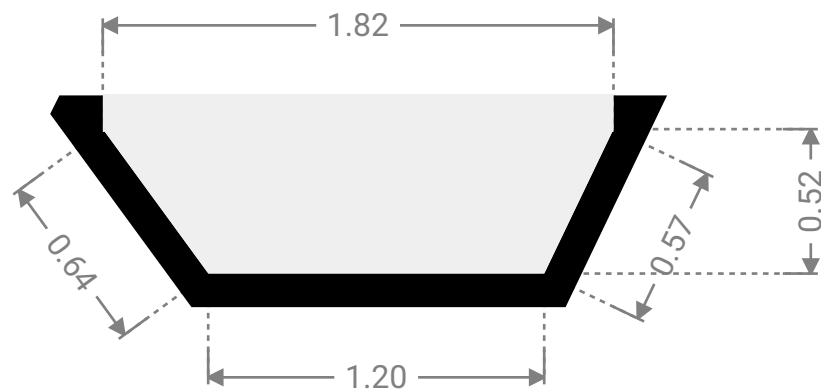
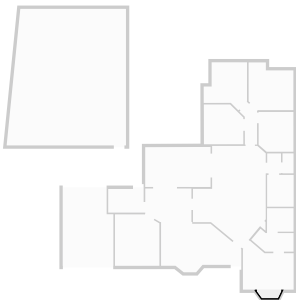

▼ **Master Bedroom**
Ground Floor

WIDTH: 3.83 m • LENGTH: 3.68 m
AREA: 11.34 m² • PERIMETER: 14.08 m

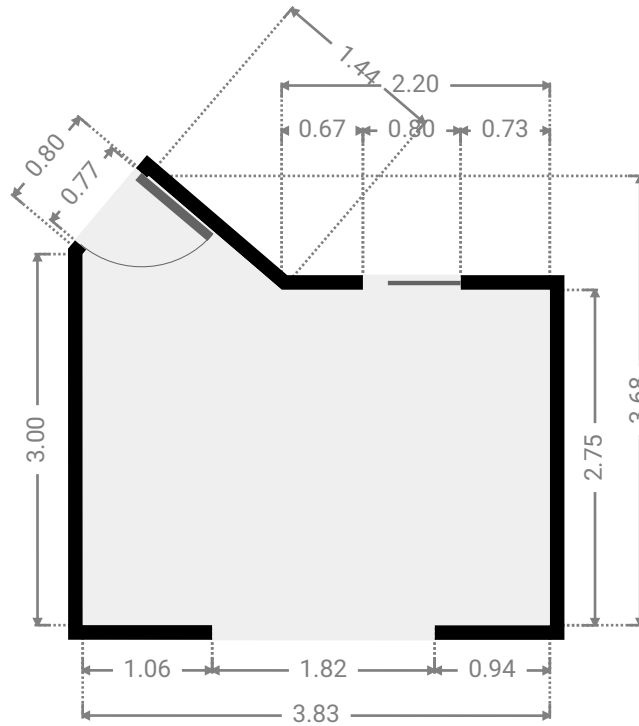
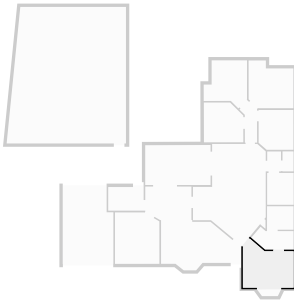

▼ **Closet**
Ground Floor

WIDTH: 3.19 m • LENGTH: 1.73 m
AREA: 4.00 m² • PERIMETER: 8.62 m

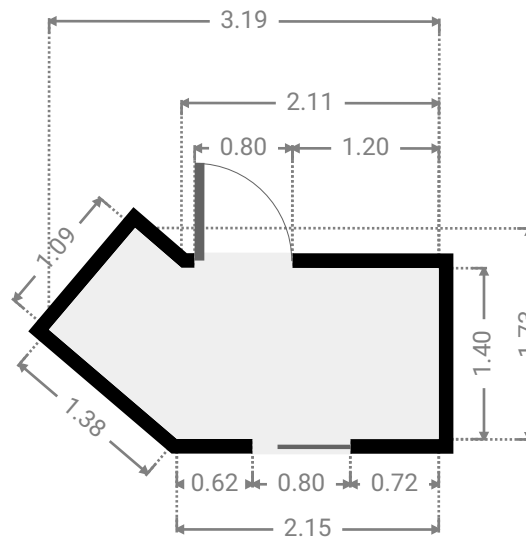
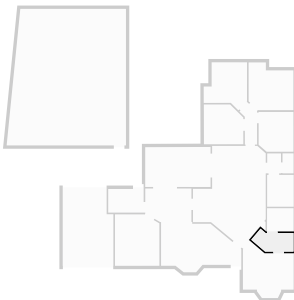

▼ Bathroom
Ground Floor

WIDTH: 2.00 m • LENGTH: 1.77 m
AREA: 3.54 m² • PERIMETER: 7.54 m

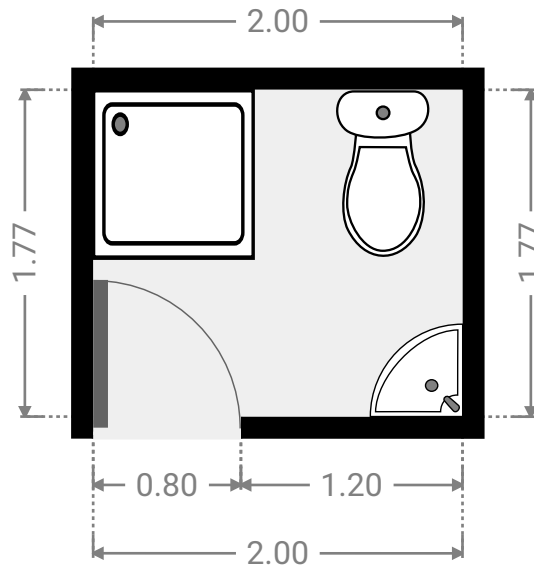
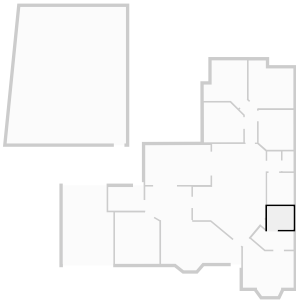

▼ Bathroom
Ground Floor

WIDTH: 2.00 m • LENGTH: 2.40 m
AREA: 4.80 m² • PERIMETER: 8.80 m

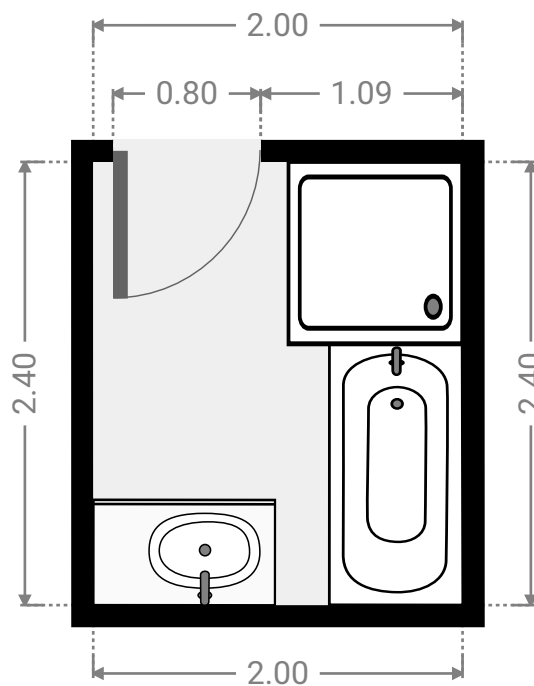
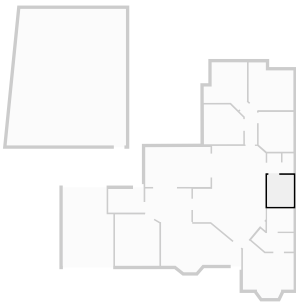

▼ Toilet
Ground Floor

WIDTH: 0.83 m • LENGTH: 1.51 m
AREA: 1.25 m² • PERIMETER: 4.67 m

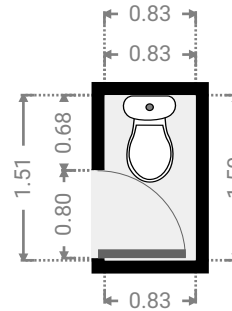
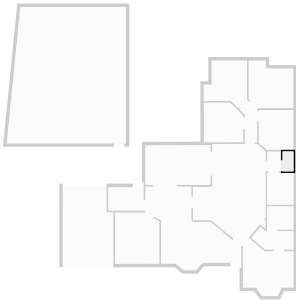

▼ Living Room
Ground Floor

WIDTH: 6.05 m • LENGTH: 3.66 m
AREA: 17.45 m² • PERIMETER: 17.57 m

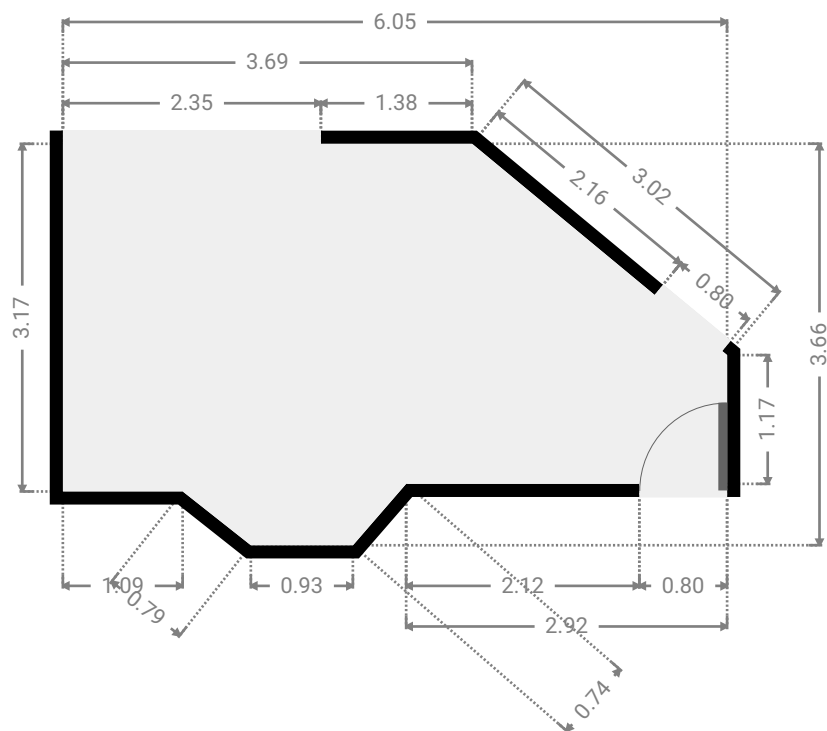
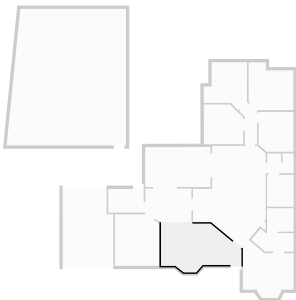

▼ **Bedroom**
Ground Floor

WIDTH: 3.28 m • LENGTH: 3.63 m
AREA: 9.21 m² • PERIMETER: 13.07 m

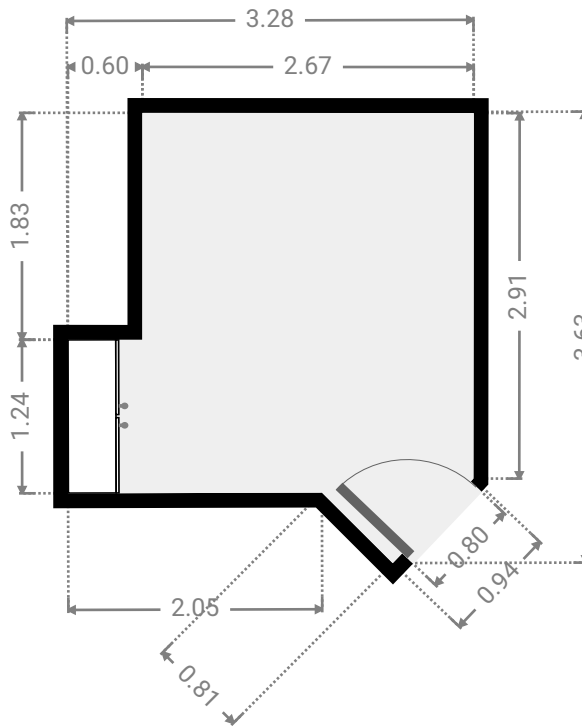
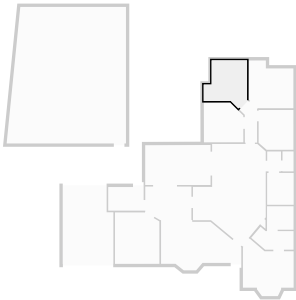

▼ **Bedroom**
Ground Floor

WIDTH: 3.38 m • LENGTH: 3.60 m
AREA: 10.67 m² • PERIMETER: 13.55 m

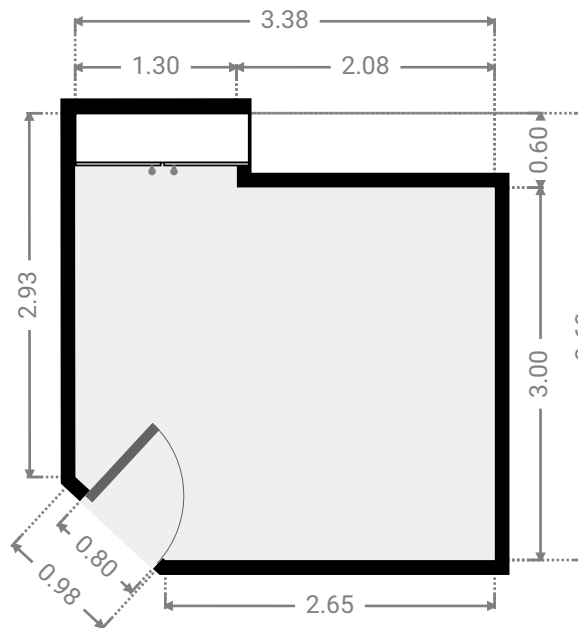
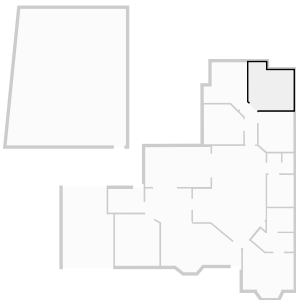

▼ **Bedroom**
Ground Floor

WIDTH: 2.63 m • LENGTH: 3.00 m
AREA: 7.71 m² • PERIMETER: 10.92 m

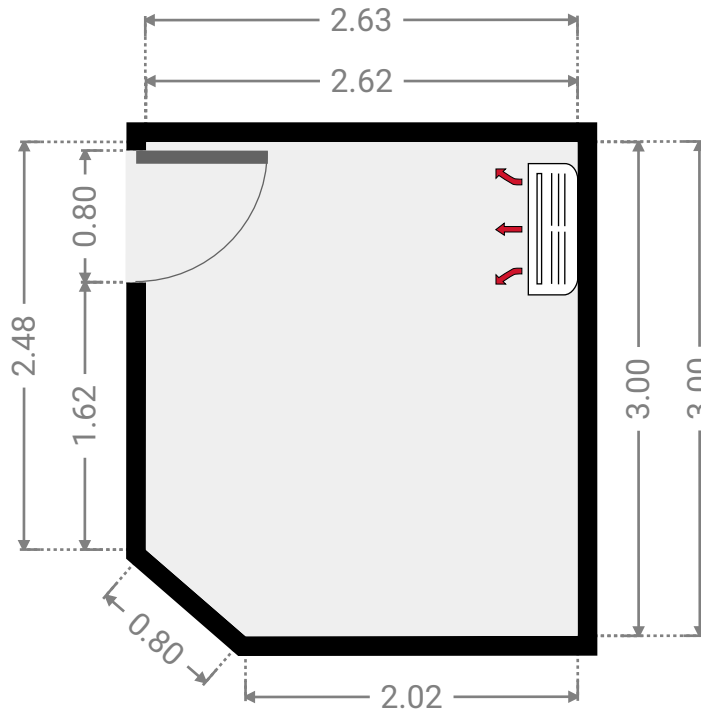
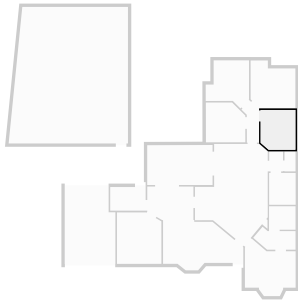

▼ **Bedroom**
Ground Floor

WIDTH: 2.97 m • LENGTH: 3.00 m
AREA: 8.42 m² • PERIMETER: 11.36 m

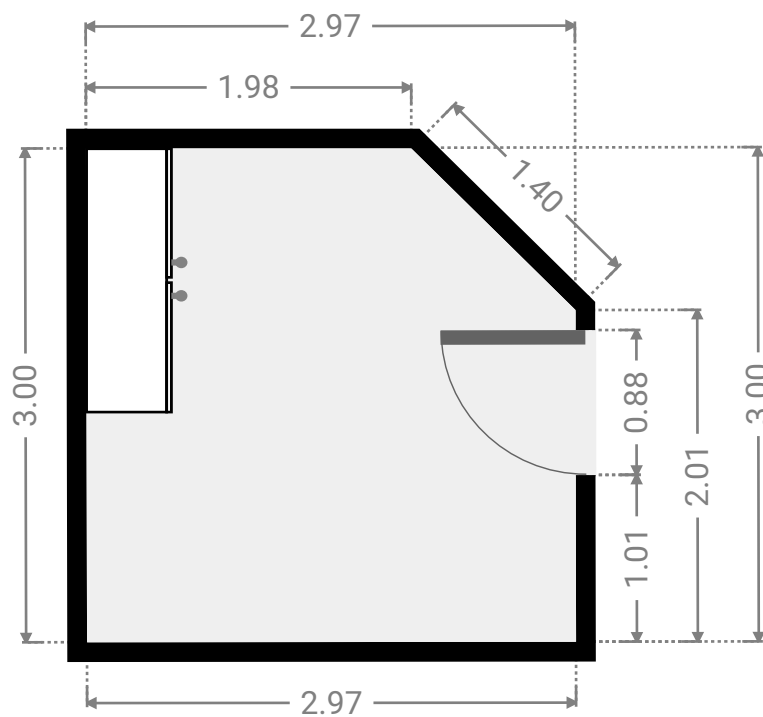
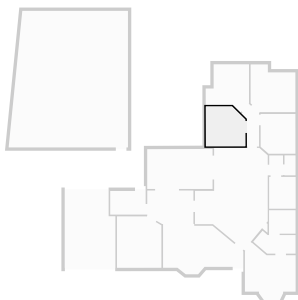

▼ Hall Ground Floor

WIDTH: 1.33 m • LENGTH: 3.16 m
AREA: 2.84 m² • PERIMETER: 7.97 m

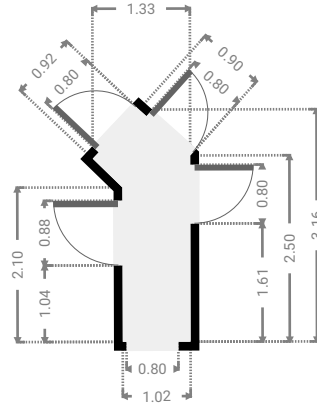
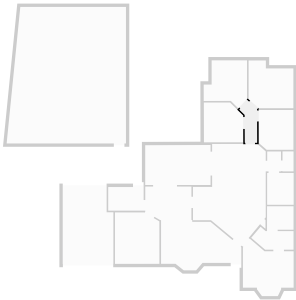

▼ Kitchen Ground Floor

WIDTH: 5.49 m • LENGTH: 7.69 m
AREA: 30.52 m² • PERIMETER: 23.63 m

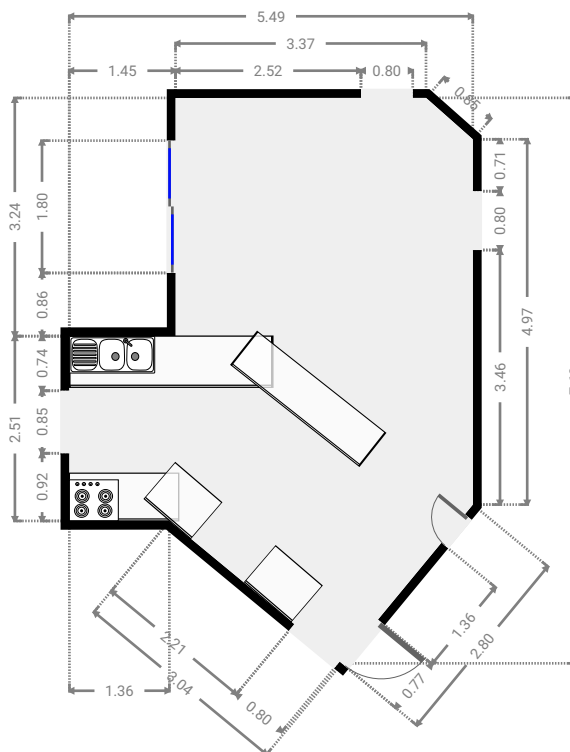
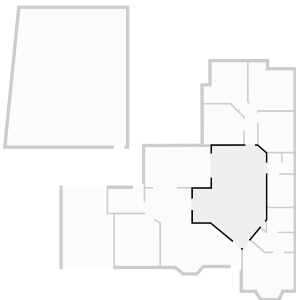

▼ **Laundry Room**
Ground Floor

WIDTH: 2.67 m • LENGTH: 1.78 m
AREA: 4.75 m² • PERIMETER: 8.90 m

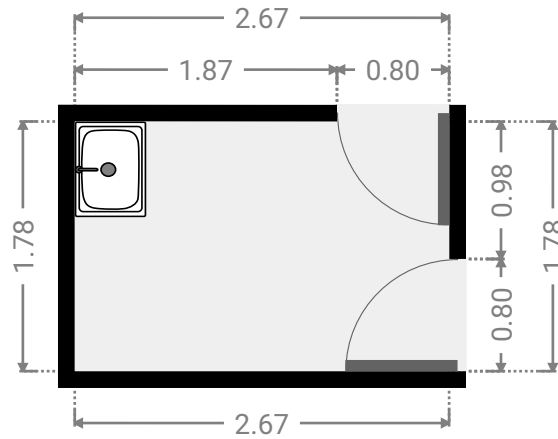
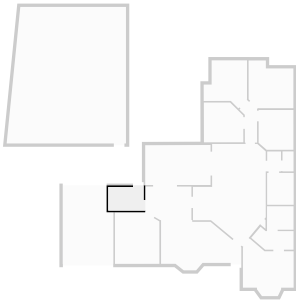

▼ **Bedroom**
Ground Floor

WIDTH: 3.35 m • LENGTH: 3.88 m
AREA: 12.60 m² • PERIMETER: 13.96 m

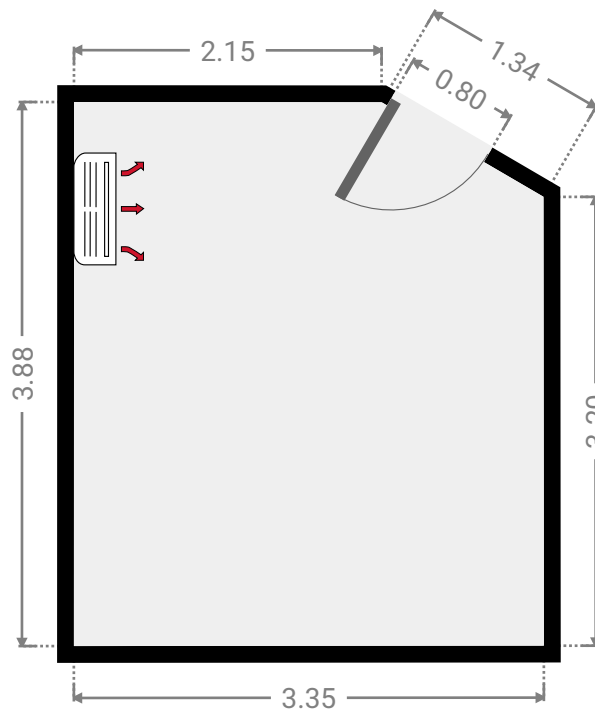
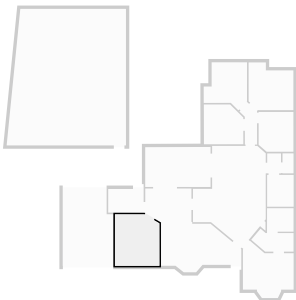

▼ Dining Room Ground Floor

WIDTH: 3.48 m • LENGTH: 2.53 m
AREA: 8.44 m² • PERIMETER: 11.55 m

