

31 Cowap Street

Ground Floor

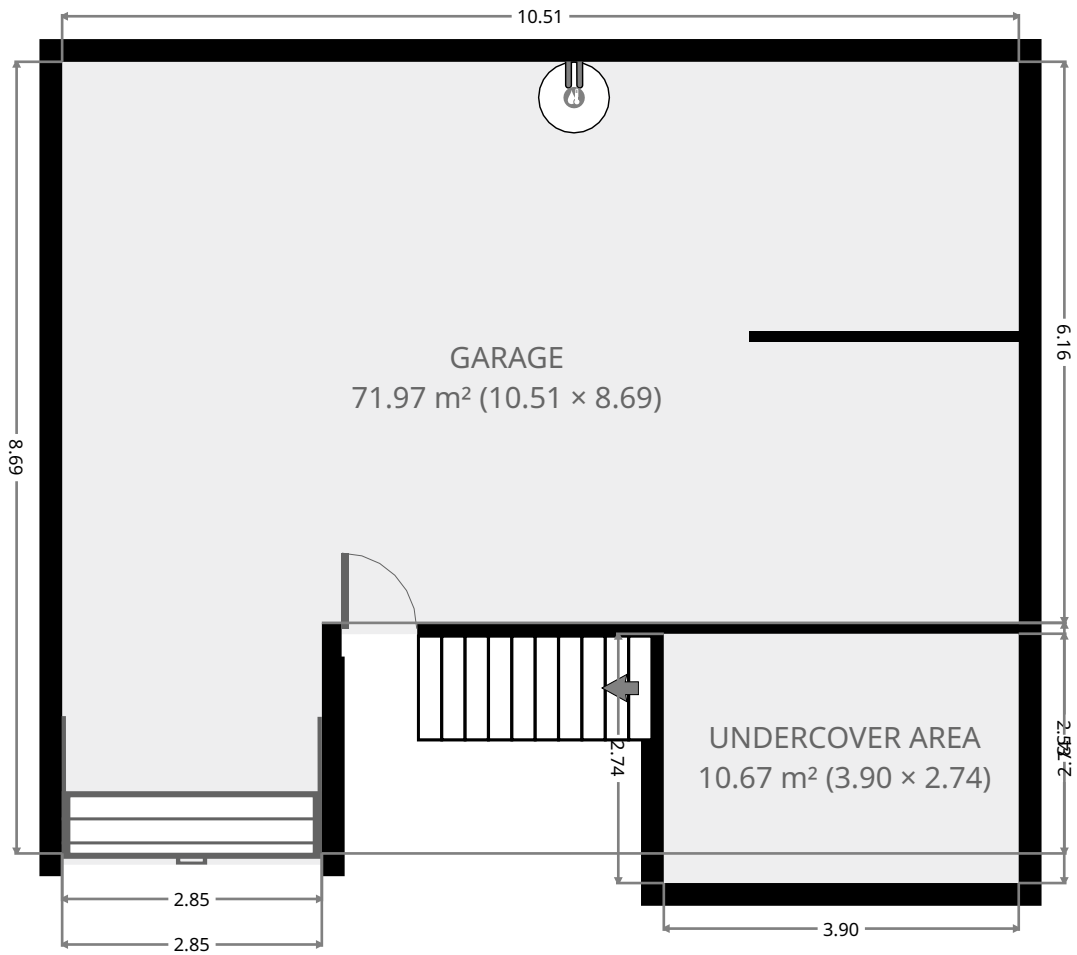

THIS FLOORPLAN IS PROVIDED WITHOUT WARRANTY OF ANY KIND. SENSOPIA DISCLAIMS ANY WARRANTY INCLUDING, WITHOUT LIMITATION, SATISFACTORY QUALITY OR ACCURACY OF DIMENSIONS.



31 Cowap Street

Garage

Width: 8.69 m
Length: 10.51 m
Area: 71.97 m²
Perimeter: 38.40 m

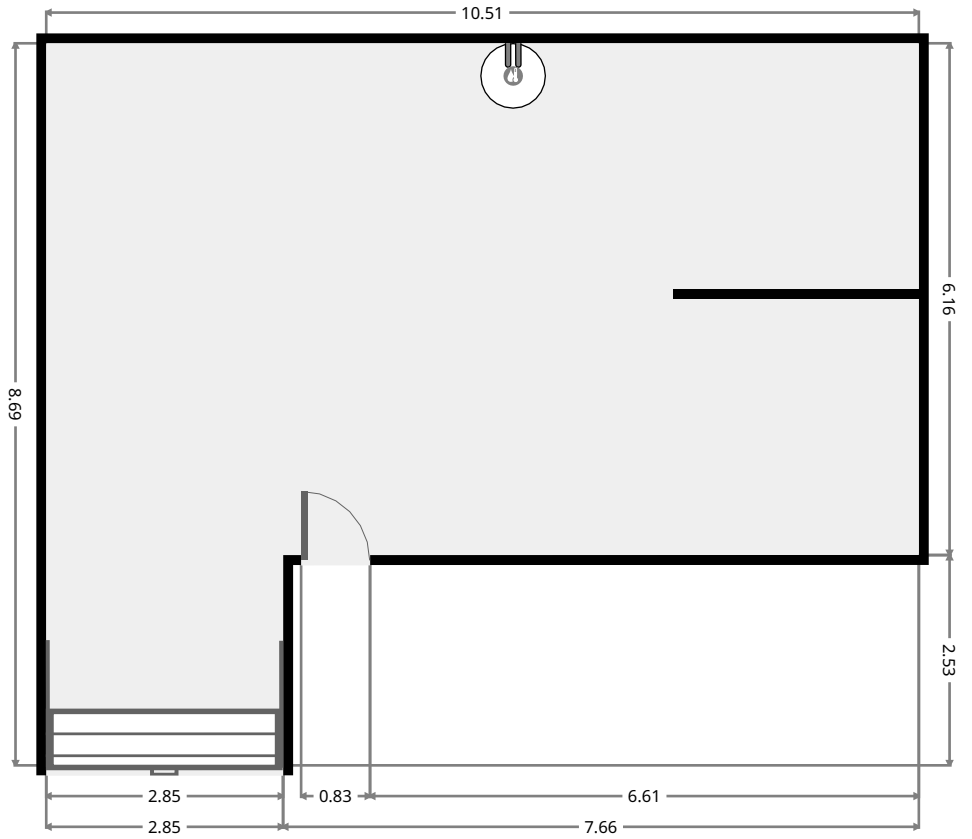
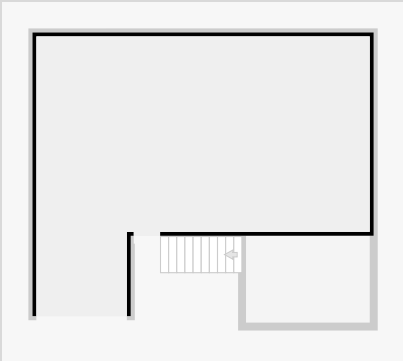

THIS FLOORPLAN IS PROVIDED WITHOUT WARRANTY OF ANY KIND. SENSOPIA DISCLAIMS ANY WARRANTY INCLUDING, WITHOUT LIMITATION, SATISFACTORY QUALITY OR ACCURACY OF DIMENSIONS.



31 Cowap Street

UnderCover Area

Width: 2.74 m
Length: 3.90 m
Area: 10.67 m²
Perimeter: 13.27 m

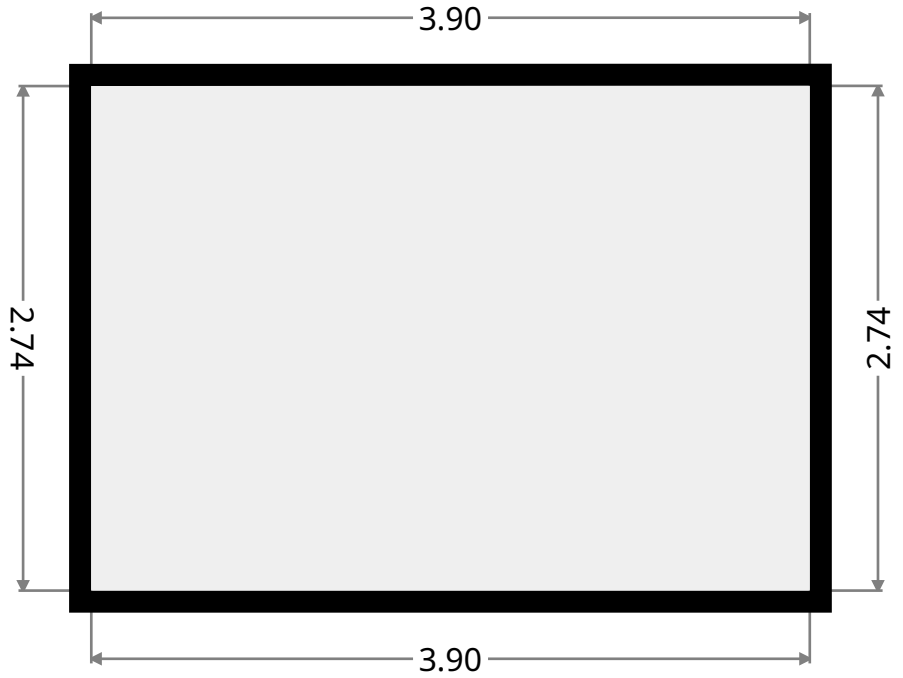
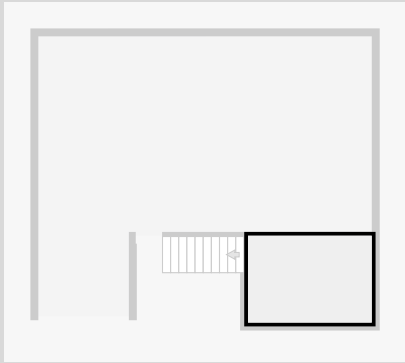

31 Cowap Street

1st Floor



THIS FLOORPLAN IS PROVIDED WITHOUT WARRANTY OF ANY KIND. SENSOPIA DISCLAIMS ANY WARRANTY INCLUDING, WITHOUT LIMITATION, SATISFACTORY QUALITY OR ACCURACY OF DIMENSIONS.

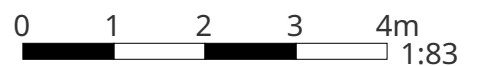

31 Cowap Street

Sunroom

Width: 2.05 m
 Length: 4.21 m
 Area: 8.63 m²
 Perimeter: 12.53 m

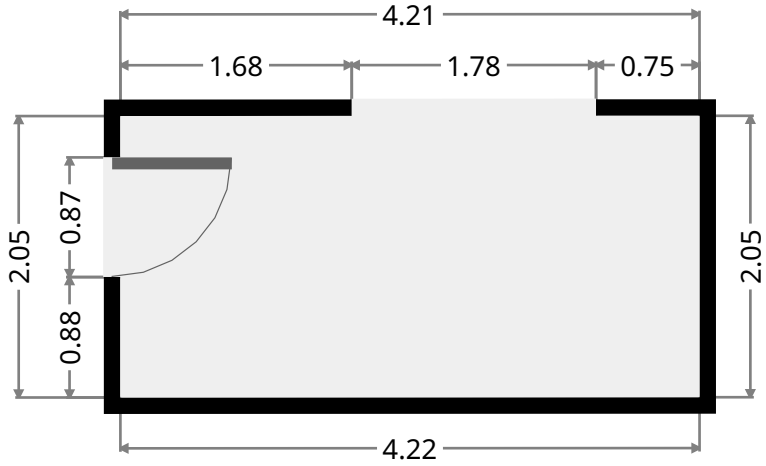
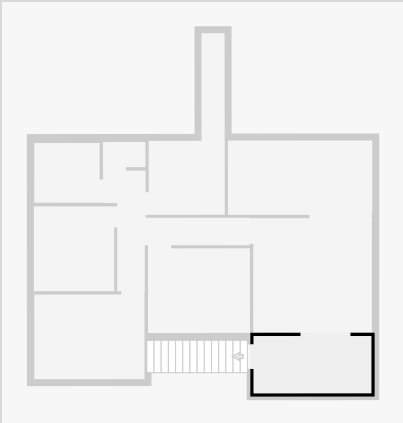

Living Room

Width: 4.10 m
 Length: 4.26 m
 Area: 17.44 m²
 Perimeter: 16.71 m

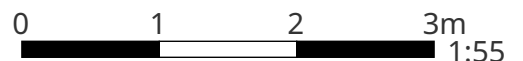
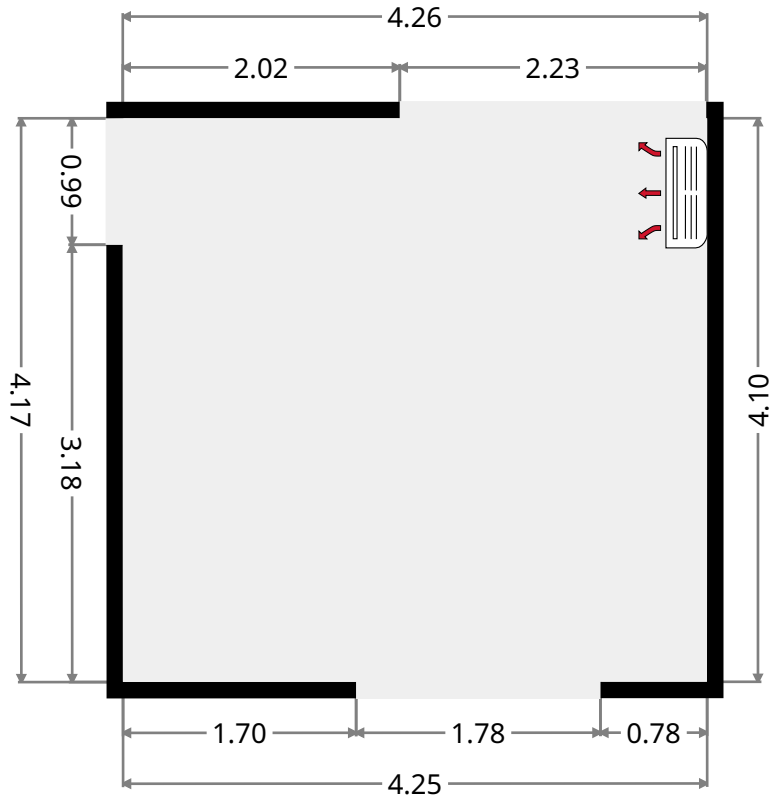
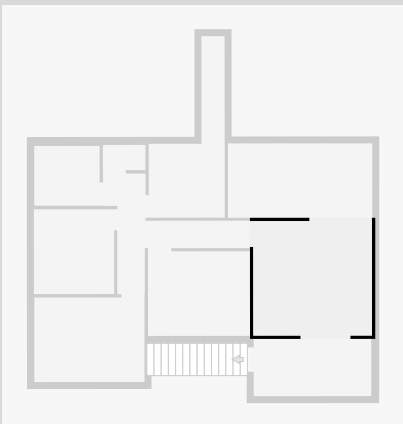

THIS FLOORPLAN IS PROVIDED WITHOUT WARRANTY OF ANY KIND. SENSOPIA DISCLAIMS ANY WARRANTY INCLUDING, WITHOUT LIMITATION, SATISFACTORY QUALITY OR ACCURACY OF DIMENSIONS.

31 Cowap Street

Kitchen/Dining

Width: 2.66 m
 Length: 5.18 m
 Area: 13.79 m²
 Perimeter: 15.68 m

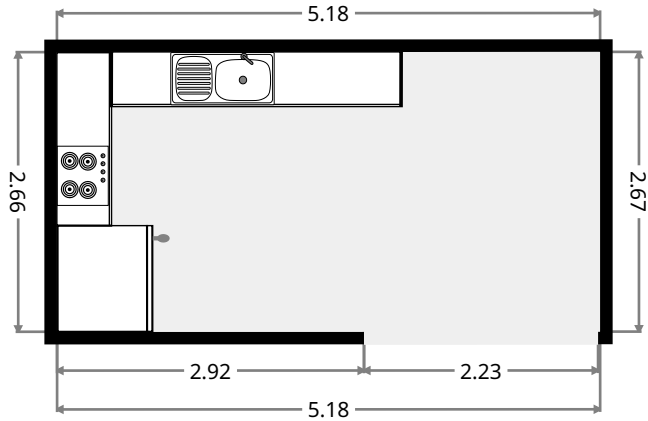
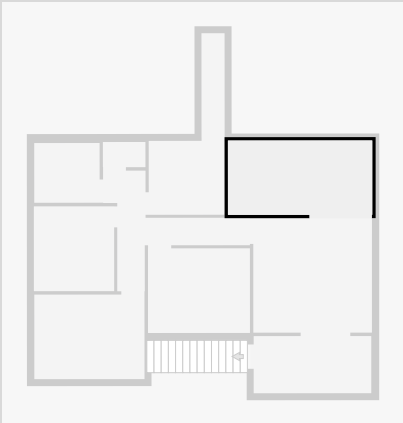

Hall

Width: 4.32 m
 Length: 5.26 m
 Area: 8.61 m²
 Perimeter: 19.17 m

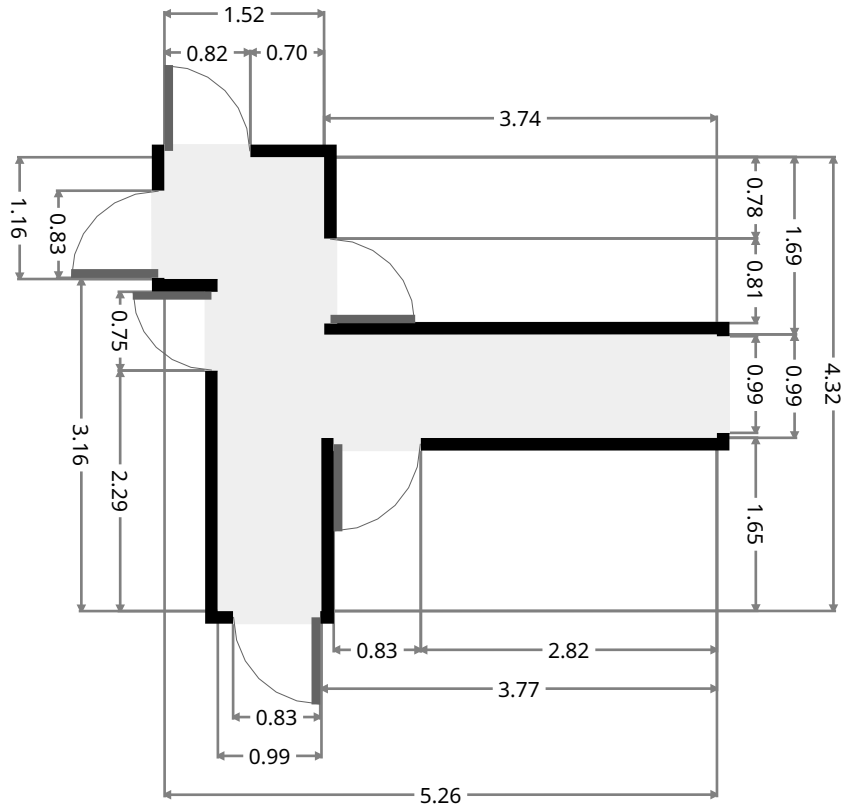
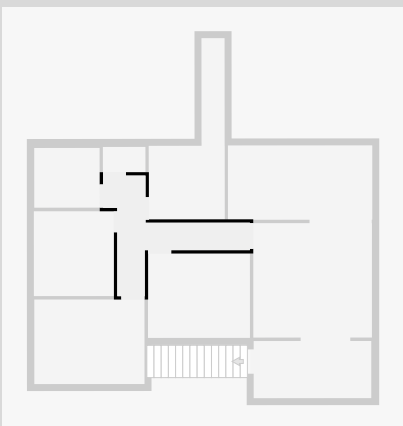

THIS FLOORPLAN IS PROVIDED WITHOUT WARRANTY OF ANY KIND. SENSOPIA DISCLAIMS ANY WARRANTY INCLUDING, WITHOUT LIMITATION, SATISFACTORY QUALITY OR ACCURACY OF DIMENSIONS.

31 Cowap Street

Bedroom

Width: 3.03 m
 Length: 3.65 m
 Area: 11.09 m²
 Perimeter: 13.38 m

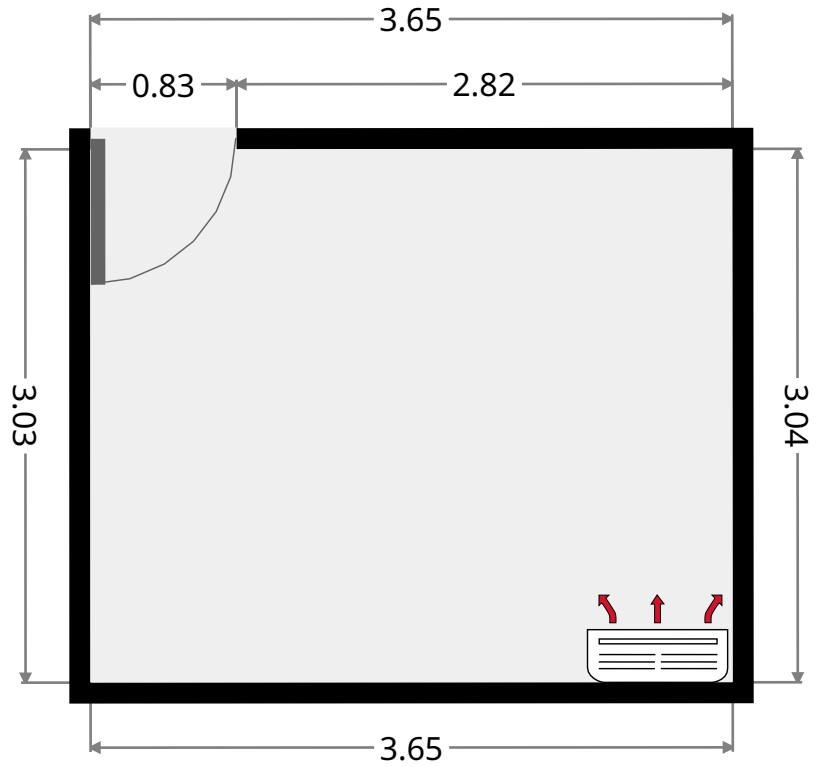
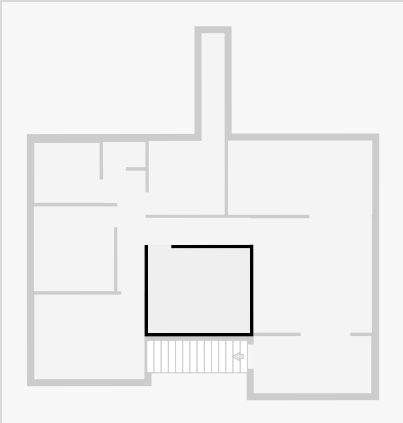

Bedroom

Width: 3.03 m
 Length: 3.95 m
 Area: 11.97 m²
 Perimeter: 13.96 m

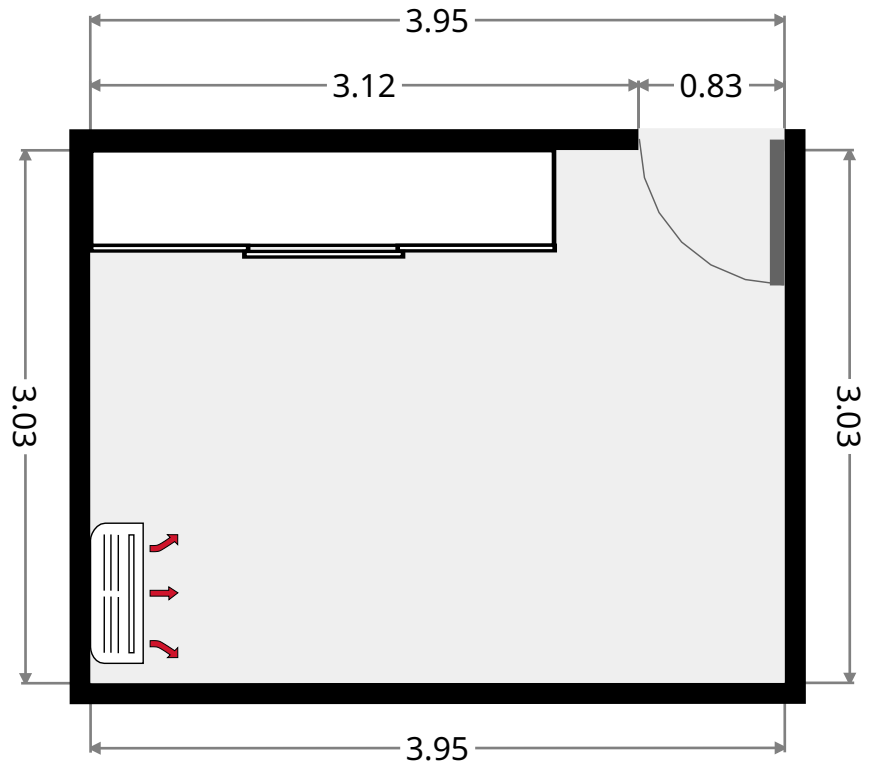
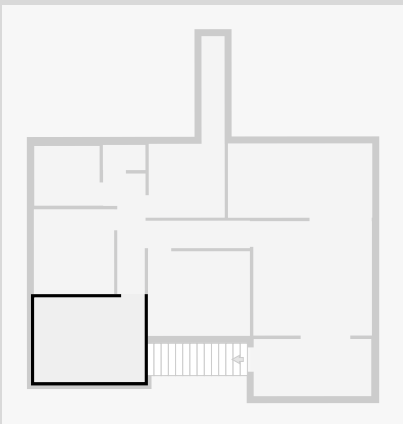

THIS FLOORPLAN IS PROVIDED WITHOUT WARRANTY OF ANY KIND. SENSOPIA DISCLAIMS ANY WARRANTY INCLUDING, WITHOUT LIMITATION, SATISFACTORY QUALITY OR ACCURACY OF DIMENSIONS.

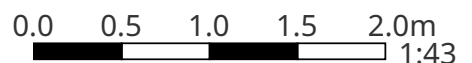

31 Cowap Street

Bedroom

Width: 2.89 m
Length: 3.04 m
Area: 8.75 m²
Perimeter: 11.84 m

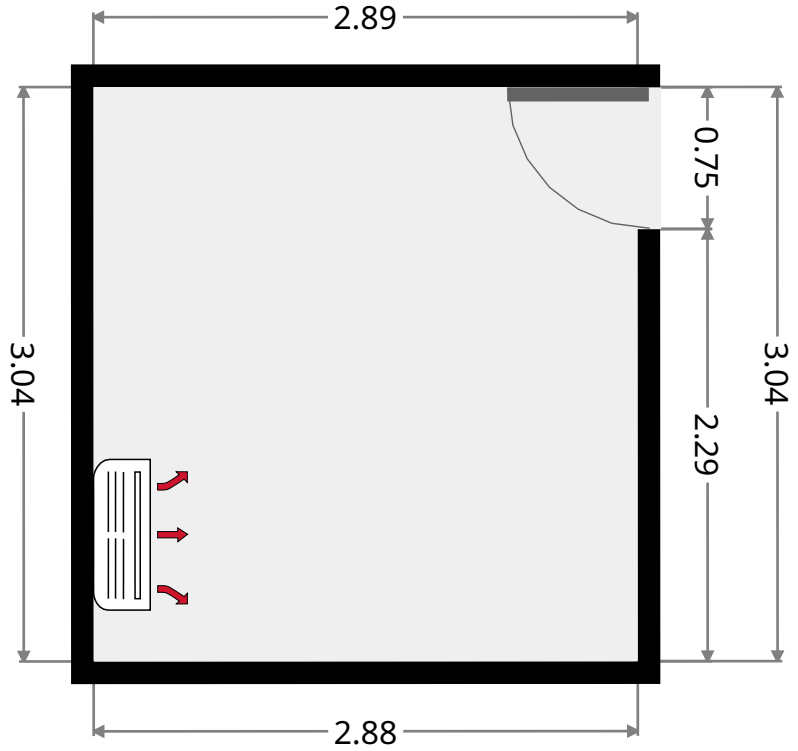
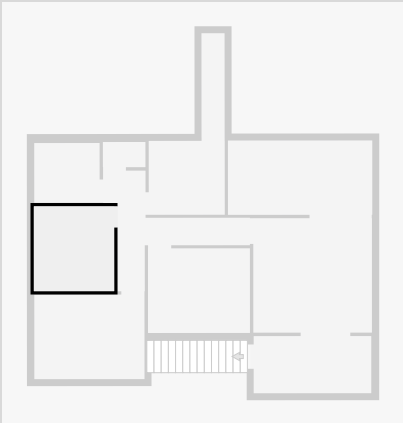

Bathroom

Width: 2.14 m
Length: 2.34 m
Area: 5.02 m²
Perimeter: 8.97 m

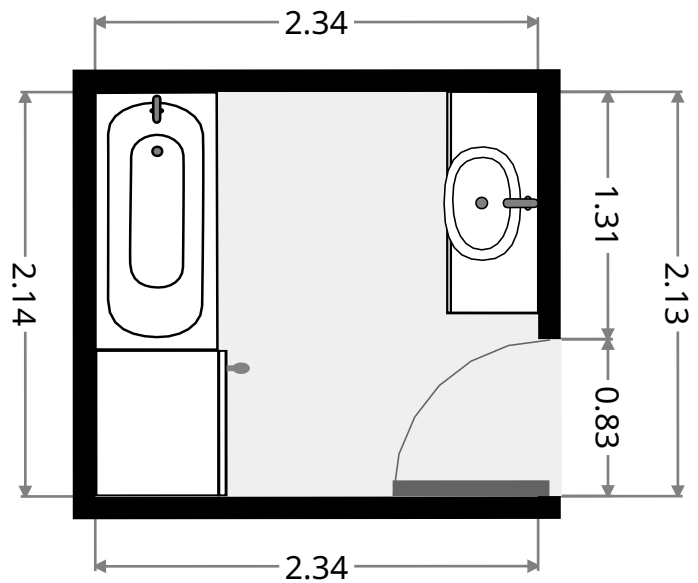
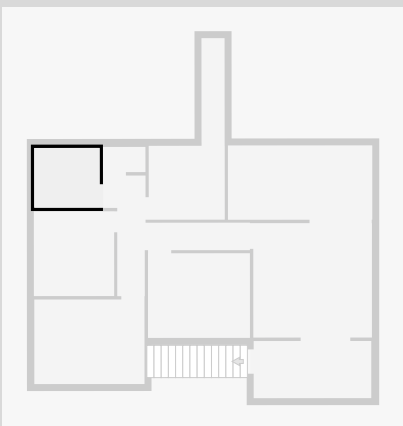

THIS FLOORPLAN IS PROVIDED WITHOUT WARRANTY OF ANY KIND. SENSOPIA DISCLAIMS ANY WARRANTY INCLUDING, WITHOUT LIMITATION, SATISFACTORY QUALITY OR ACCURACY OF DIMENSIONS.

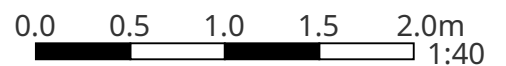

31 Cowap Street

Toilet

Width: 0.90 m
 Length: 1.53 m
 Area: 1.38 m²
 Perimeter: 4.86 m

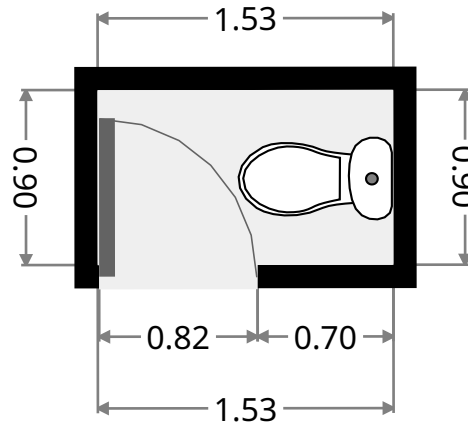
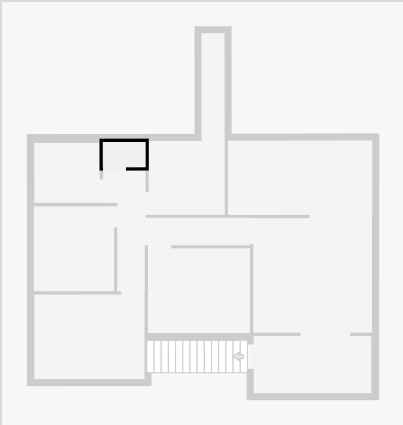

Laundry Room

Width: 2.65 m
 Length: 2.73 m
 Area: 7.21 m²
 Perimeter: 10.75 m

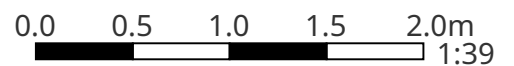
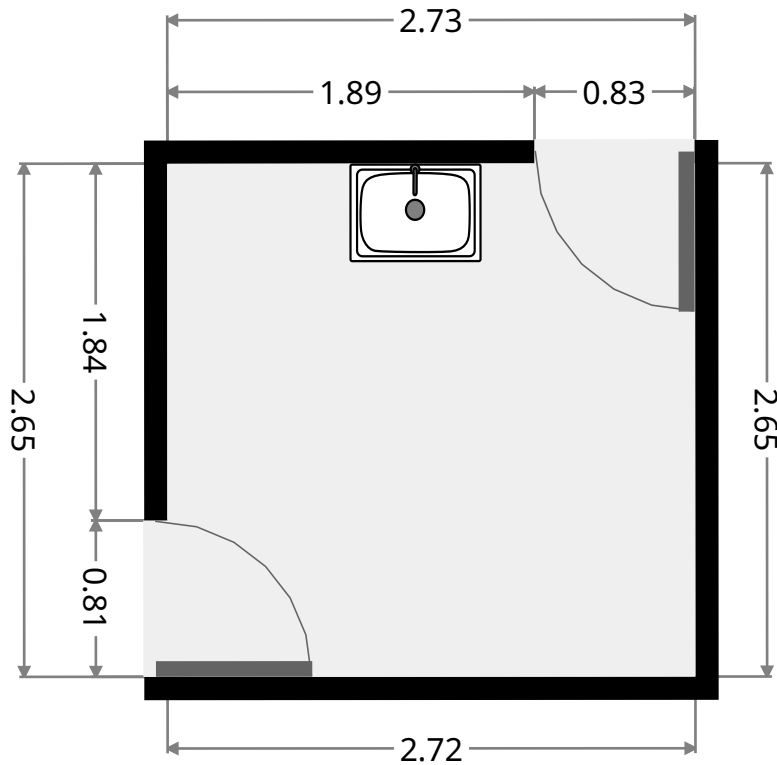
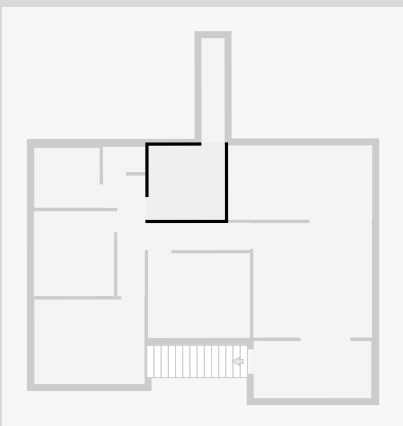

31 Cowap Street

Ramp

Width: 0.83 m
Length: 3.73 m
Area: 3.09 m²
Perimeter: 9.12 m

