

31 Bunya Road

Ground Floor

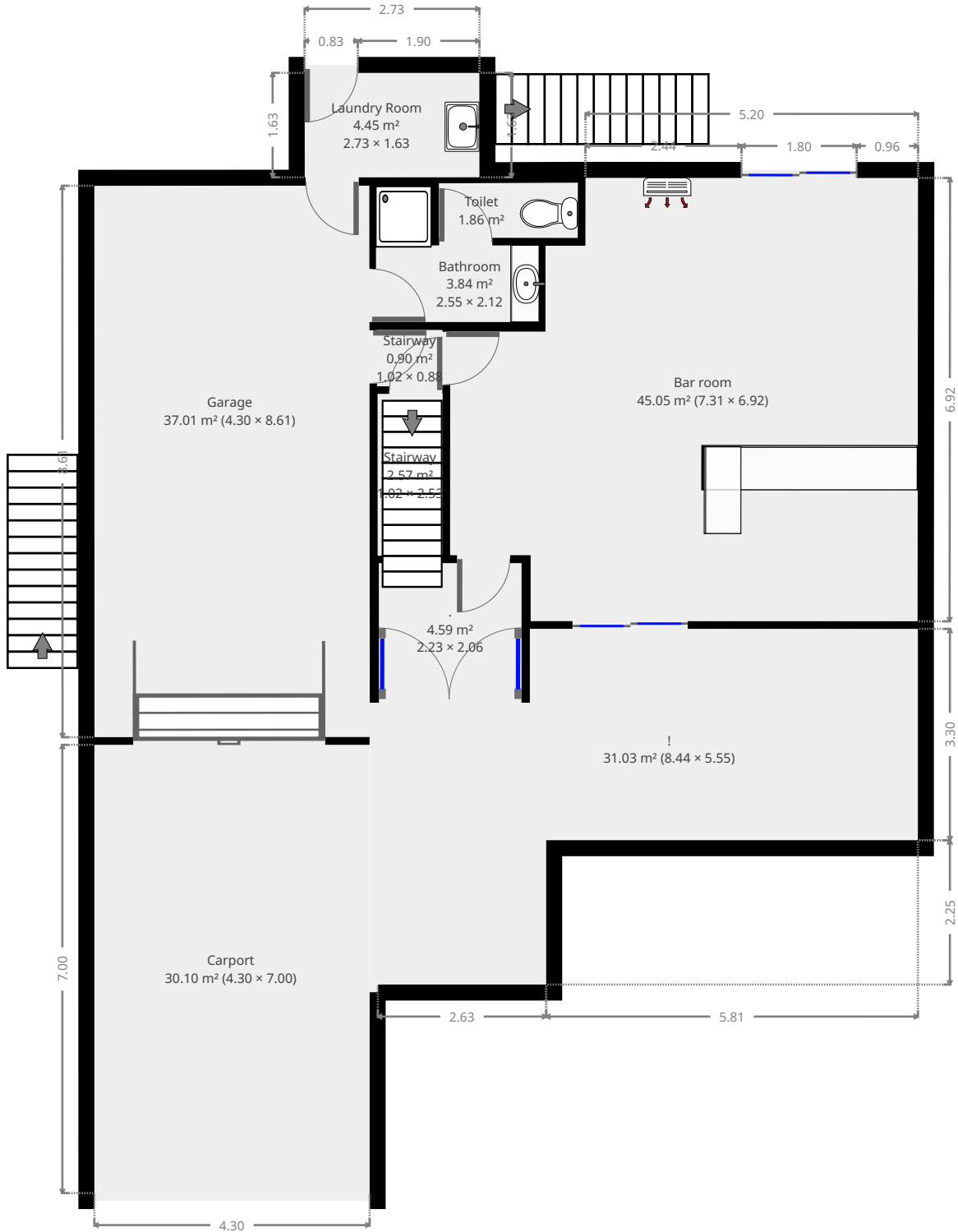

THIS FLOORPLAN IS PROVIDED WITHOUT WARRANTY OF ANY KIND. SENSOPIA DISCLAIMS ANY WARRANTY INCLUDING, WITHOUT LIMITATION, SATISFACTORY QUALITY OR ACCURACY OF DIMENSIONS.



31 Bunya Road

Bar room

Width: 6.92 m
 Length: 7.31 m
 Area: 45.05 m²
 Perimeter: 28.46 m

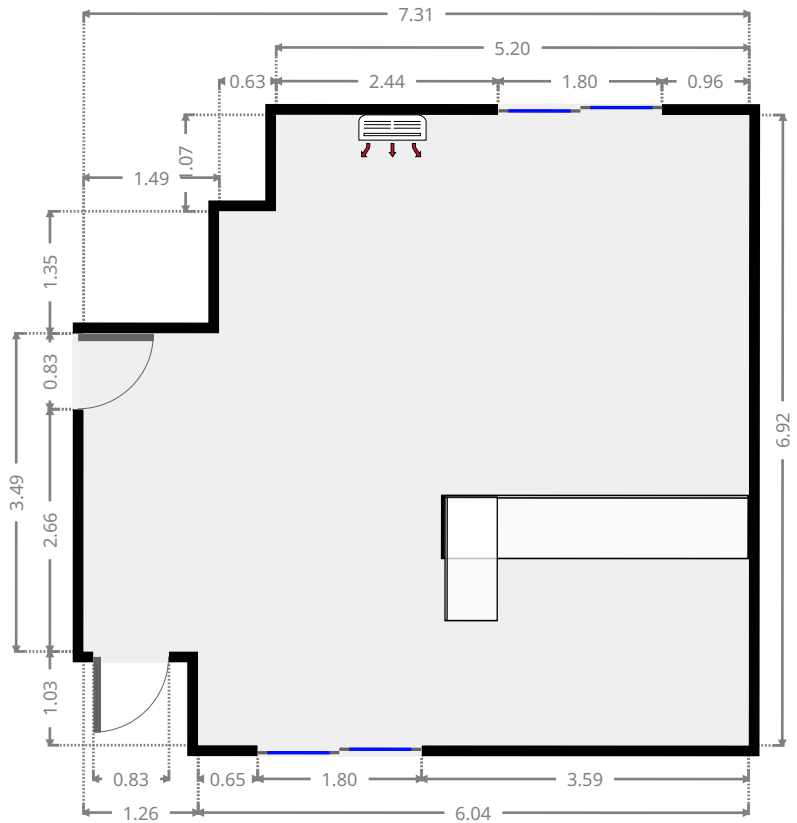
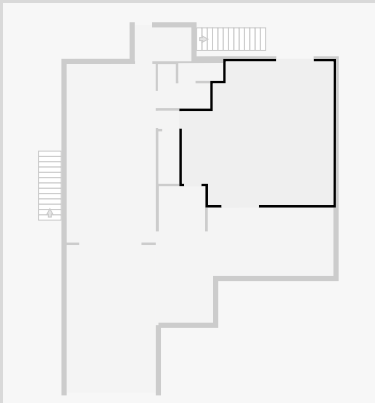

Stairway

Width: 0.88 m
 Length: 1.02 m
 Area: 0.90 m²
 Perimeter: 3.80 m

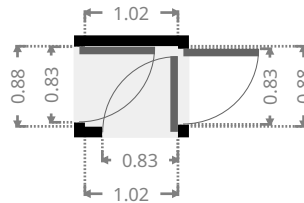
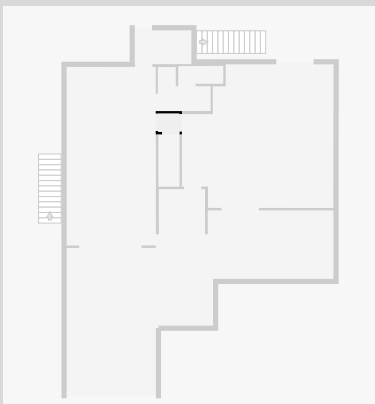

31 Bunya Road

Stairway

Width: 1.02 m
Length: 2.53 m
Area: 2.57 m²
Perimeter: 7.09 m

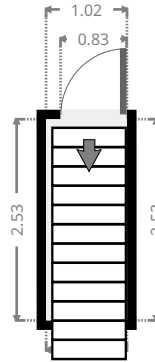
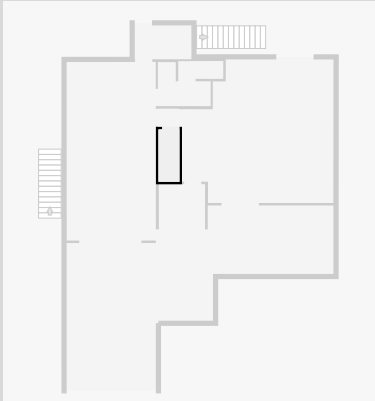

Garage

Width: 4.30 m
Length: 8.61 m
Area: 37.01 m²
Perimeter: 25.82 m

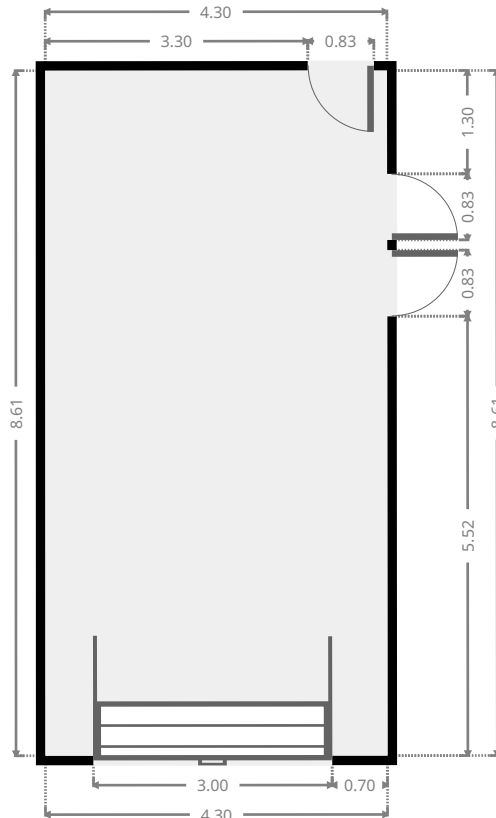
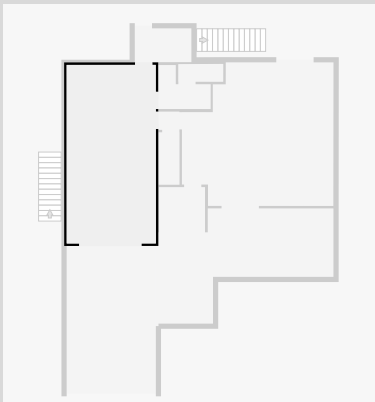

THIS FLOORPLAN IS PROVIDED WITHOUT WARRANTY OF ANY KIND. SENSOPIA DISCLAIMS ANY WARRANTY INCLUDING, WITHOUT LIMITATION, SATISFACTORY QUALITY OR ACCURACY OF DIMENSIONS.

31 Bunya Road

Bathroom

Width: 2.12 m
 Length: 2.55 m
 Area: 3.84 m²
 Perimeter: 9.33 m

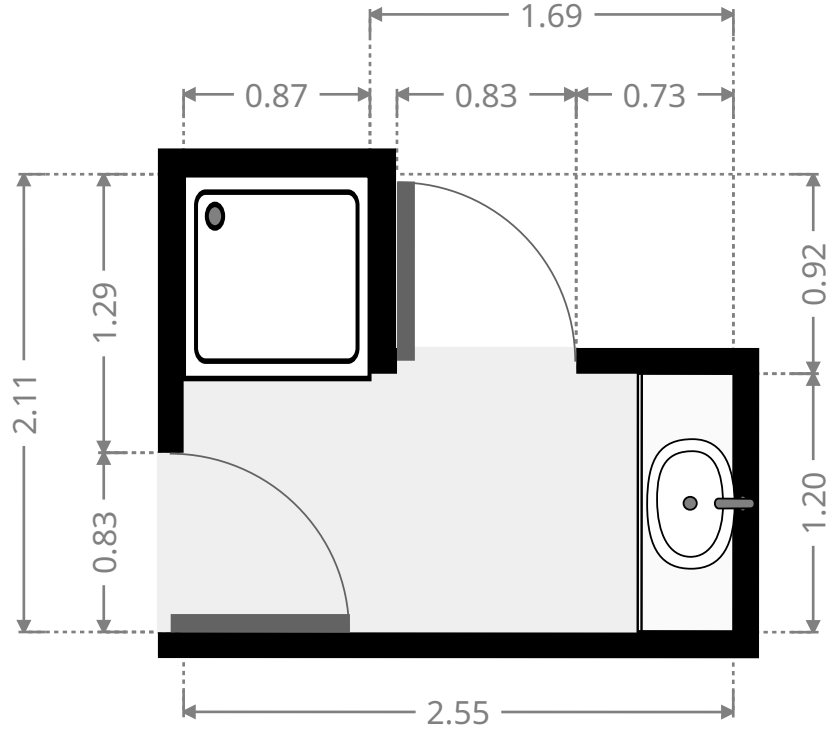
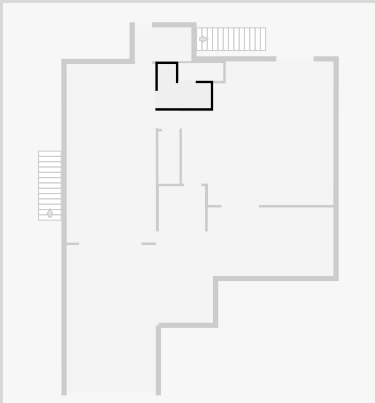

Toilet / Half Bath

Width: 0.86 m
 Length: 2.17 m
 Area: 1.86 m²
 Perimeter: 6.05 m

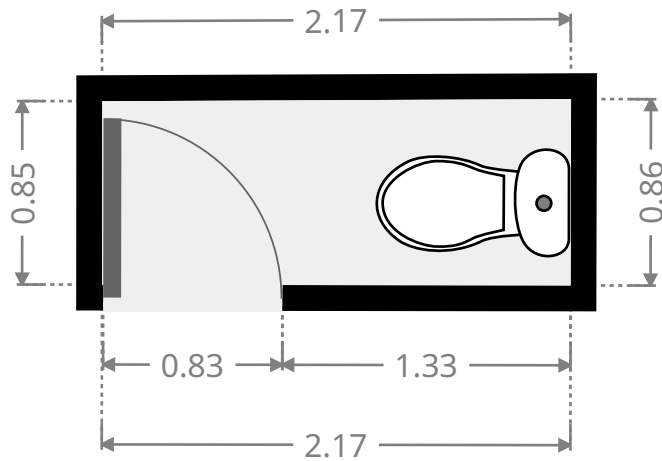
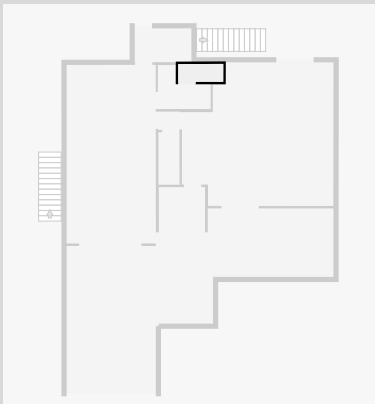

31 Bunya Road

Laundry Room

Width: 1.63 m
 Length: 2.73 m
 Area: 4.45 m²
 Perimeter: 8.72 m

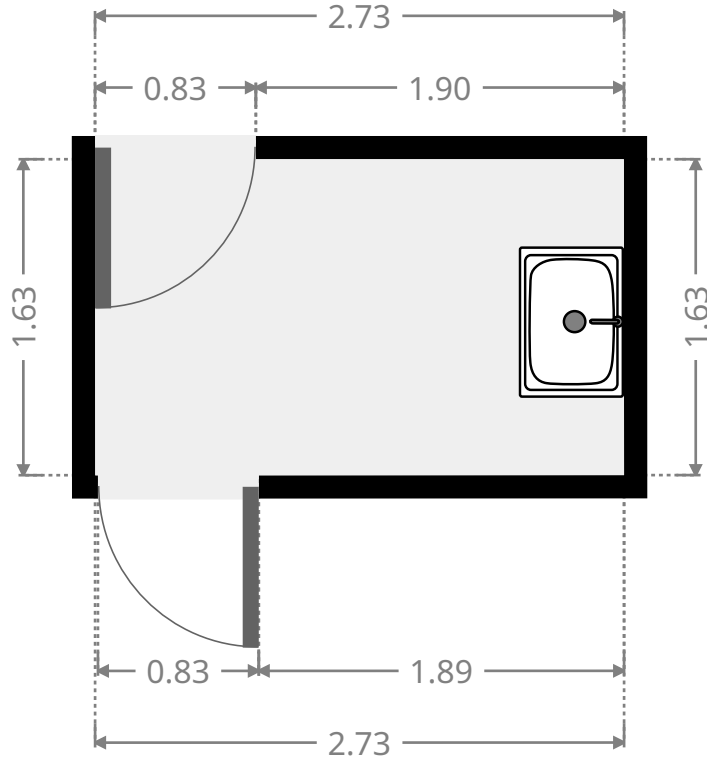
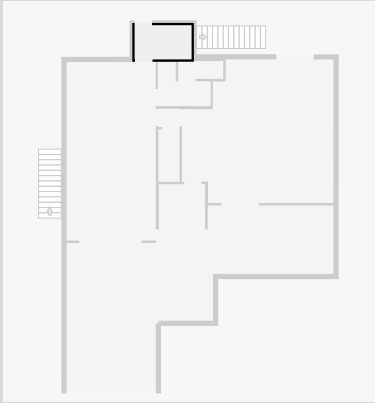

Width: 2.06 m
 Length: 2.23 m
 Area: 4.59 m²
 Perimeter: 8.58 m

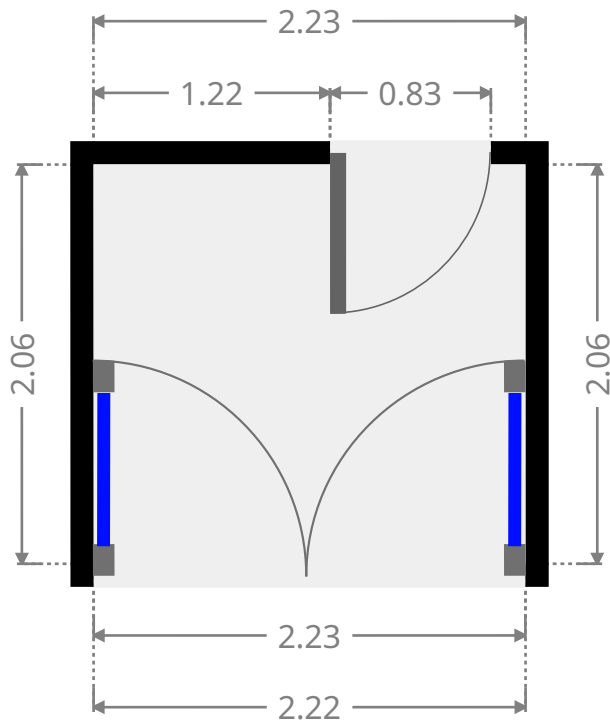
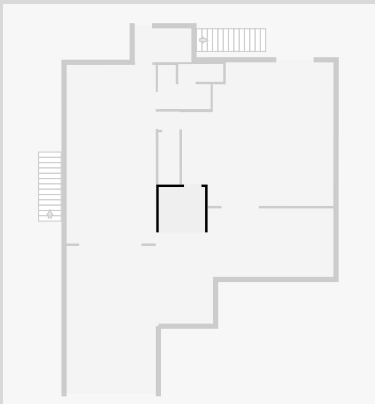

31 Bunya Road

Carport

Width: 4.30 m
 Length: 7.00 m
 Area: 30.10 m²
 Perimeter: 22.60 m

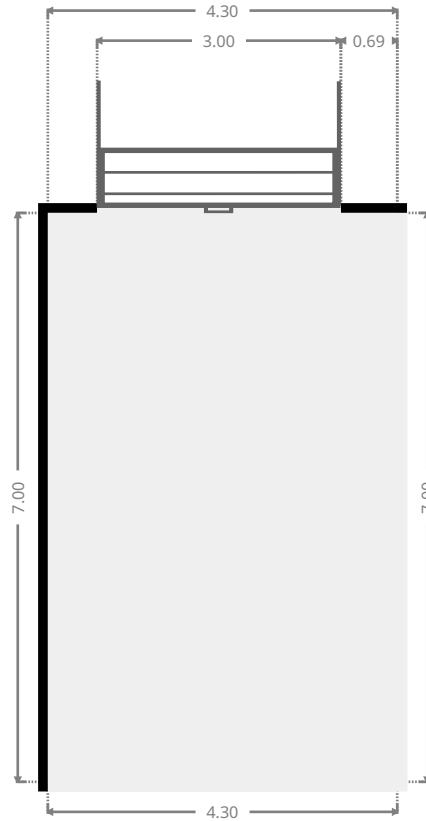
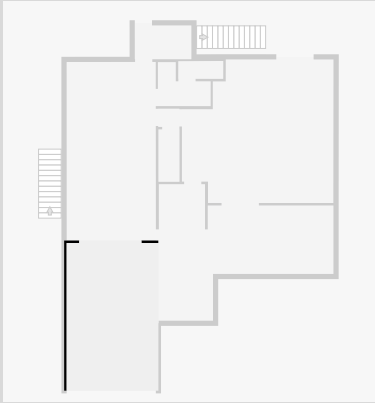

!

Width: 5.55 m
 Length: 8.44 m
 Area: 31.03 m²
 Perimeter: 27.98 m

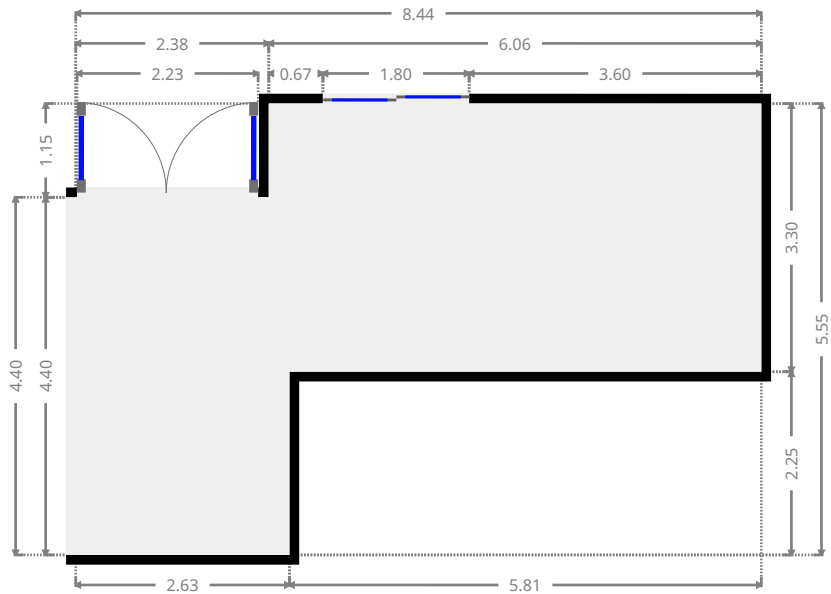
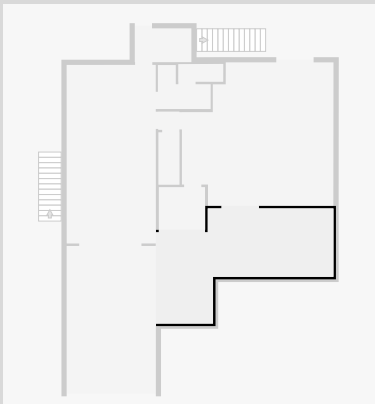

THIS FLOORPLAN IS PROVIDED WITHOUT WARRANTY OF ANY KIND. SENSOPIA DISCLAIMS ANY WARRANTY INCLUDING, WITHOUT LIMITATION, SATISFACTORY QUALITY OR ACCURACY OF DIMENSIONS.



31 Bunya Road

1st Floor

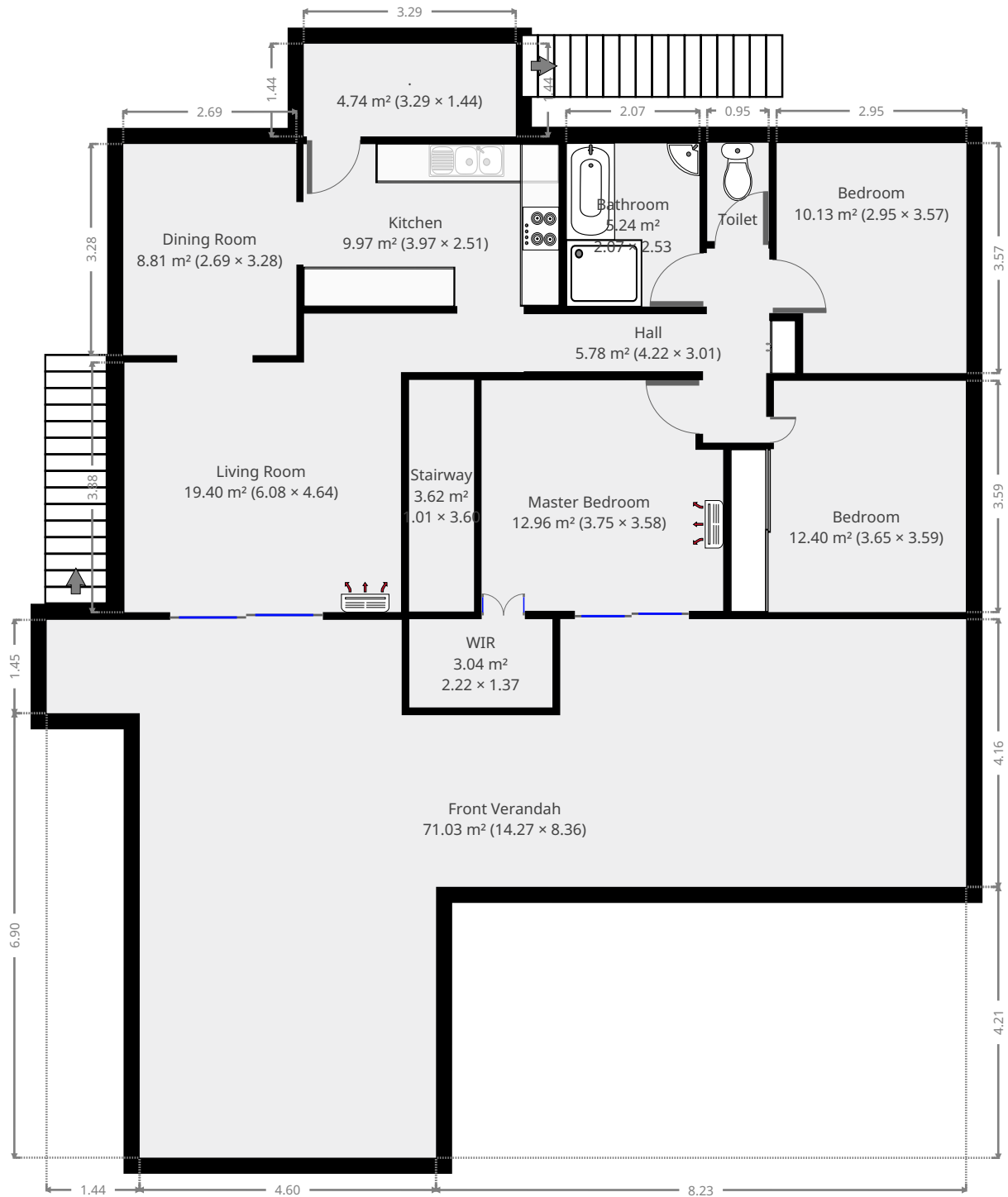

THIS FLOORPLAN IS PROVIDED WITHOUT WARRANTY OF ANY KIND. SENSOPIA DISCLAIMS ANY WARRANTY INCLUDING, WITHOUT LIMITATION, SATISFACTORY QUALITY OR ACCURACY OF DIMENSIONS.

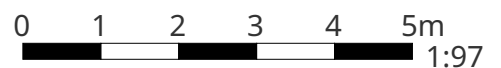

31 Bunya Road

Bedroom

Width: 3.59 m
 Length: 3.65 m
 Area: 12.40 m²
 Perimeter: 14.48 m

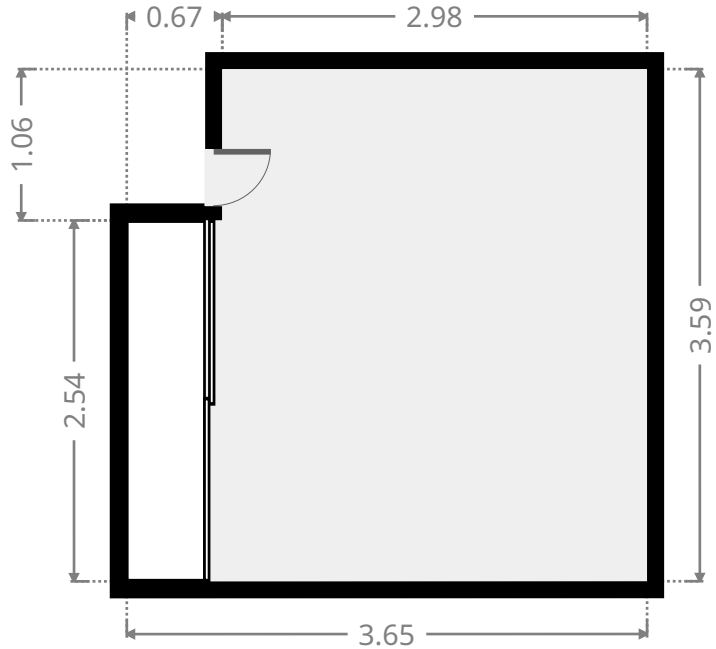
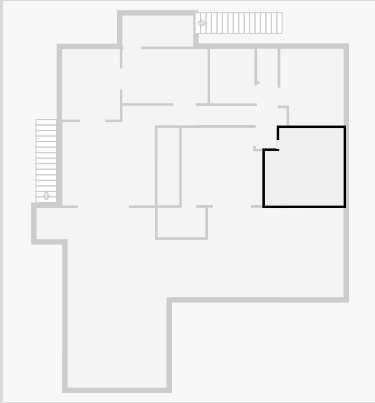

Hall

Width: 3.01 m
 Length: 4.22 m
 Area: 5.78 m²
 Perimeter: 14.47 m

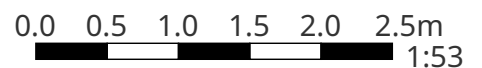
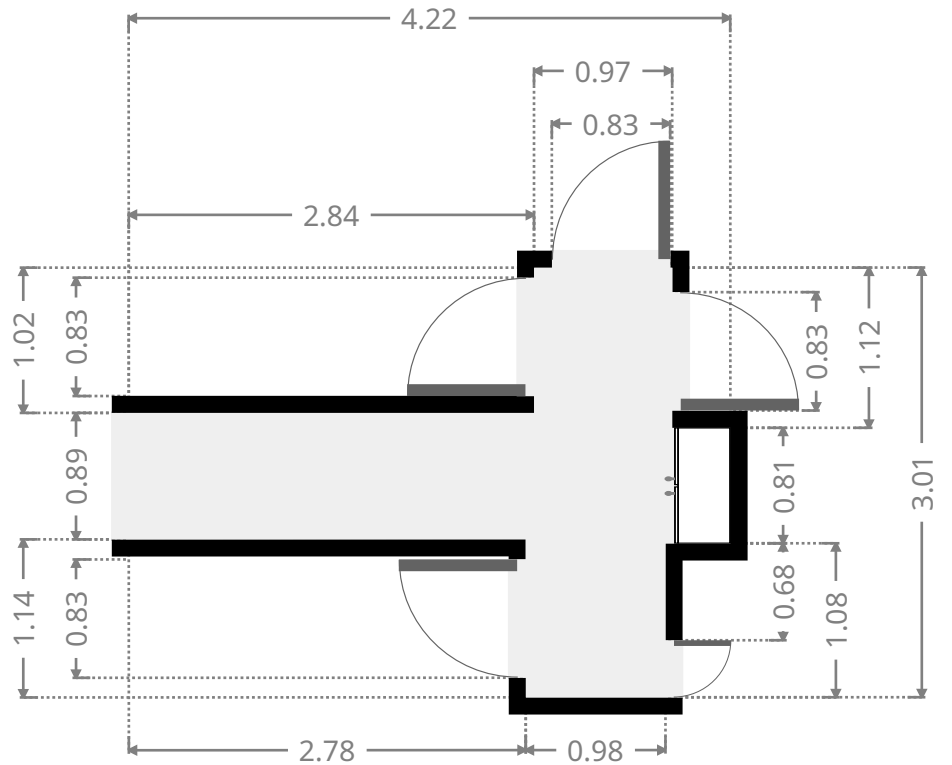
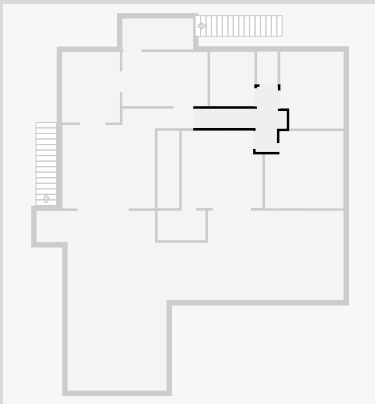

THIS FLOORPLAN IS PROVIDED WITHOUT WARRANTY OF ANY KIND. SENSOPIA DISCLAIMS ANY WARRANTY INCLUDING, WITHOUT LIMITATION, SATISFACTORY QUALITY OR ACCURACY OF DIMENSIONS.

31 Bunya Road

Master Bedroom

Width: 3.58 m
 Length: 3.75 m
 Area: 12.96 m²
 Perimeter: 14.66 m

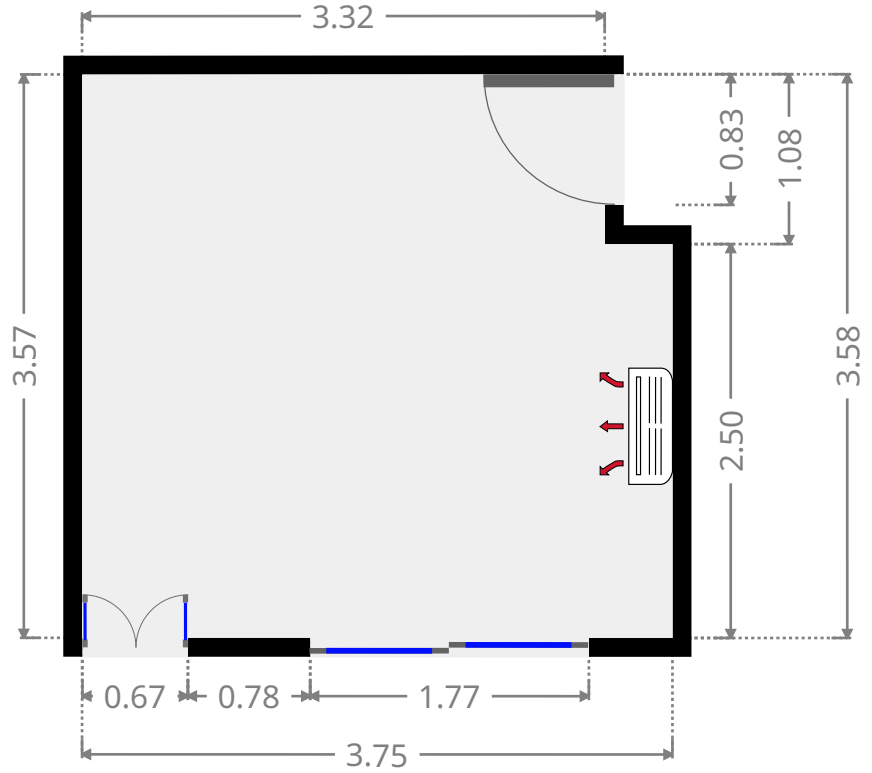
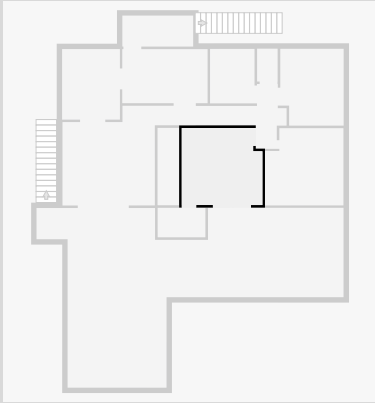

WIR

Width: 1.37 m
 Length: 2.22 m
 Area: 3.04 m²
 Perimeter: 7.18 m

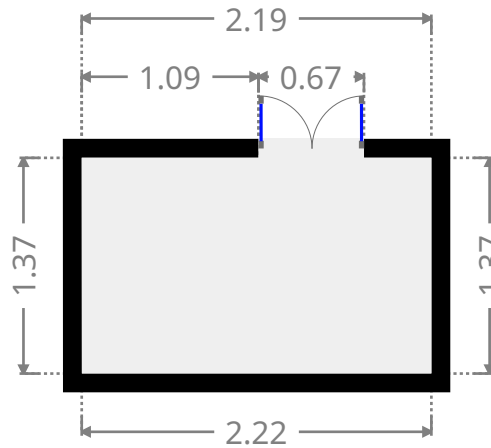
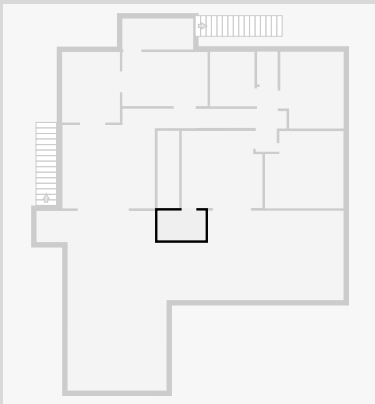

31 Bunya Road

Front Verandah

Width: 8.36 m
Length: 14.27 m
Area: 71.03 m²
Perimeter: 48.23 m

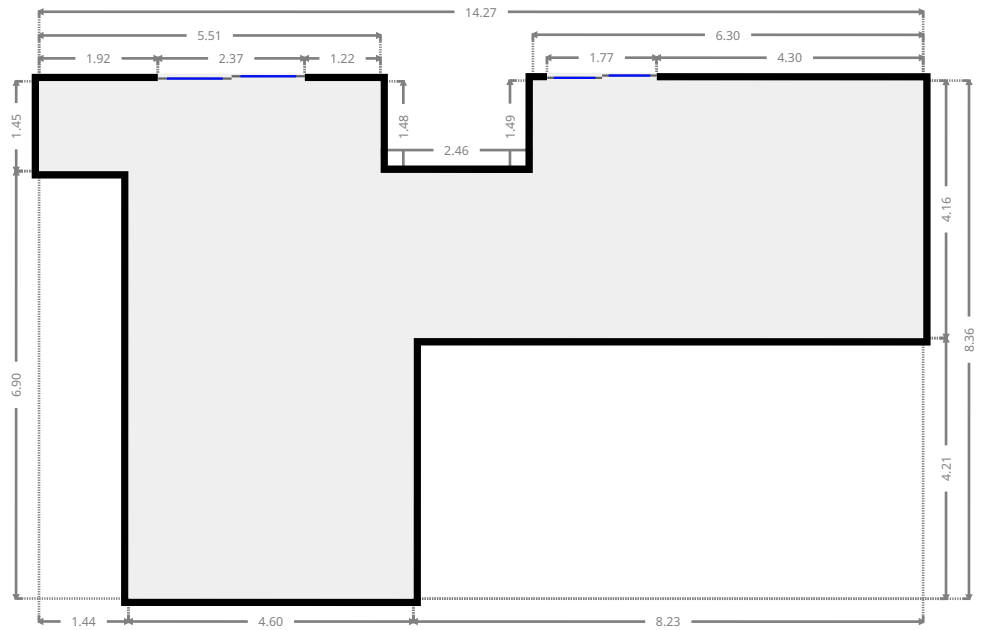
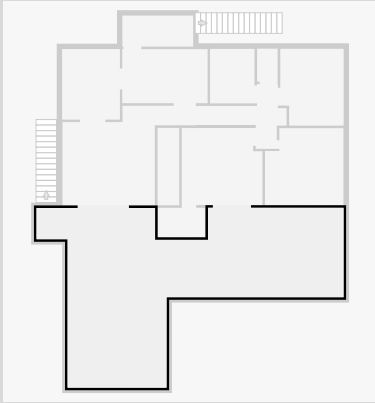

31 Bunya Road

Bedroom

Width: 2.95 m
Length: 3.57 m
Area: 10.13 m²
Perimeter: 13.03 m

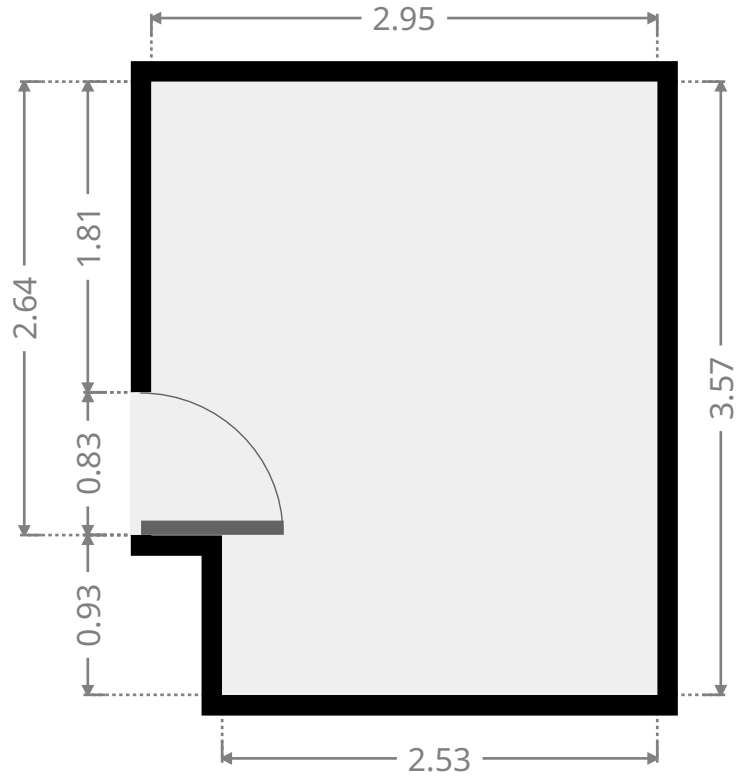
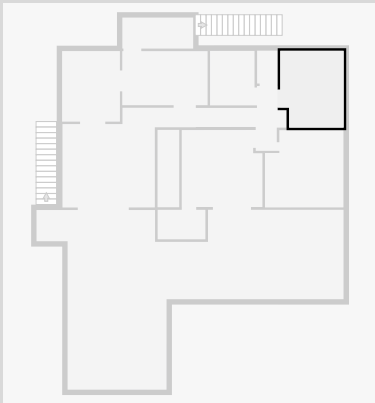

Toilet / Half Bath

Width: 0.95 m
Length: 1.53 m
Area: 1.46 m²
Perimeter: 4.96 m

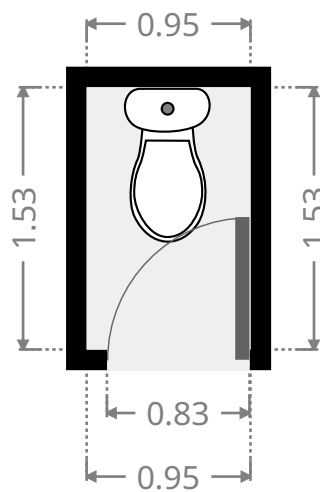
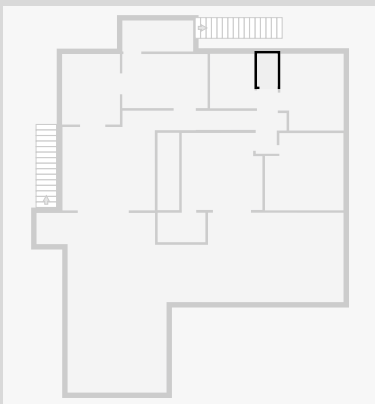

31 Bunya Road

Bathroom

Width: 2.07 m
 Length: 2.53 m
 Area: 5.24 m²
 Perimeter: 9.20 m

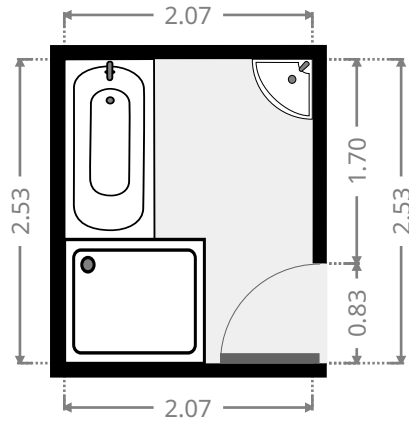
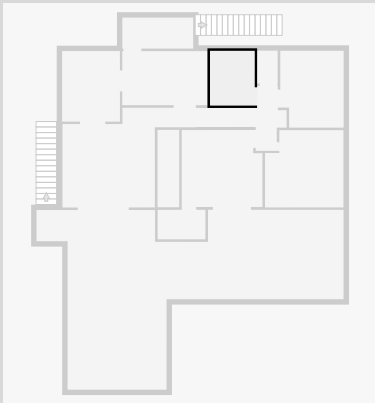

Living Room

Width: 4.64 m
 Length: 6.08 m
 Area: 19.40 m²
 Perimeter: 21.43 m

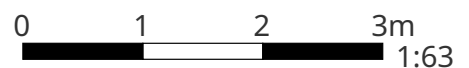
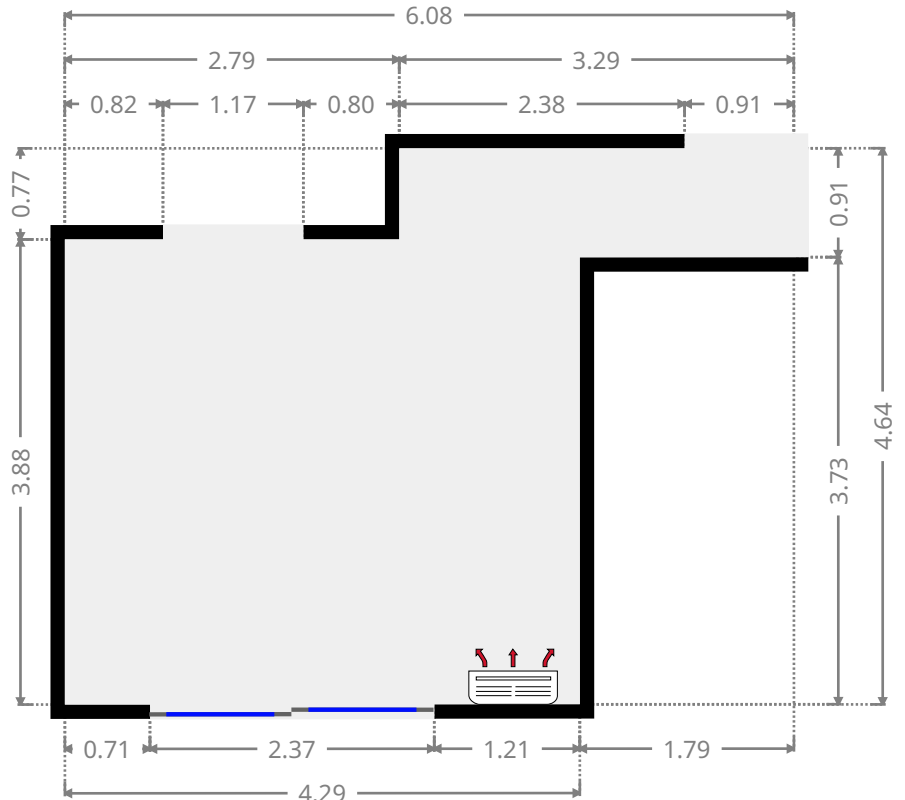
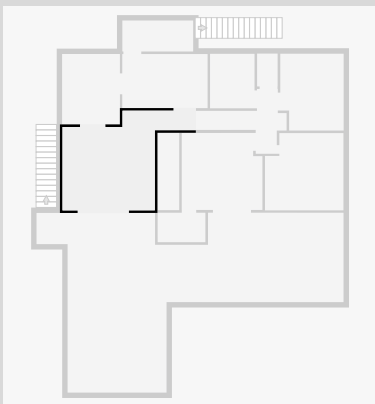

THIS FLOORPLAN IS PROVIDED WITHOUT WARRANTY OF ANY KIND. SENSOPIA DISCLAIMS ANY WARRANTY INCLUDING, WITHOUT LIMITATION, SATISFACTORY QUALITY OR ACCURACY OF DIMENSIONS.

31 Bunya Road

Dining Room

Width: 2.69 m
 Length: 3.28 m
 Area: 8.81 m²
 Perimeter: 11.93 m

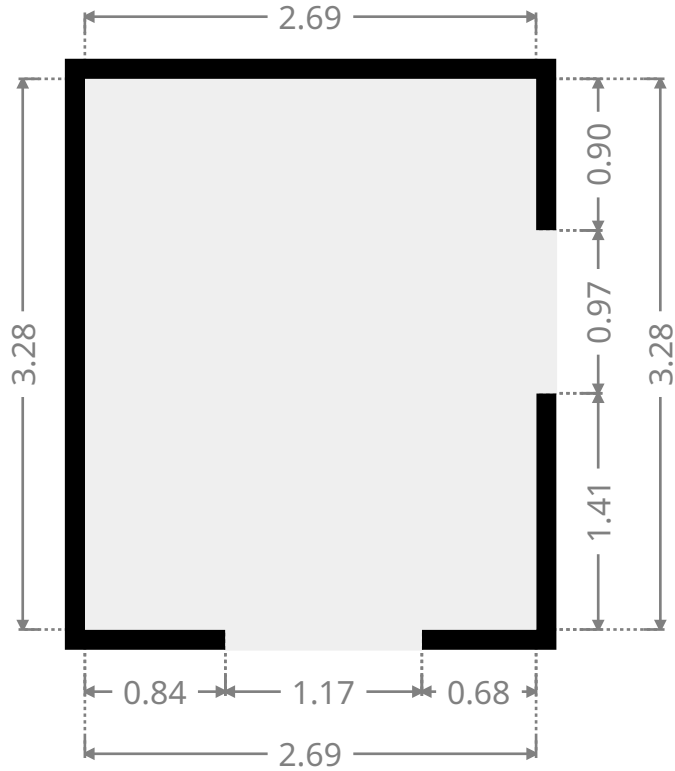
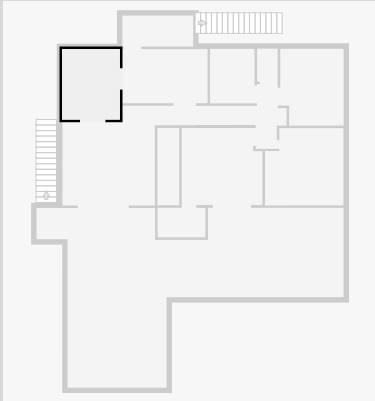

Kitchen

Width: 2.51 m
 Length: 3.97 m
 Area: 9.97 m²
 Perimeter: 12.96 m

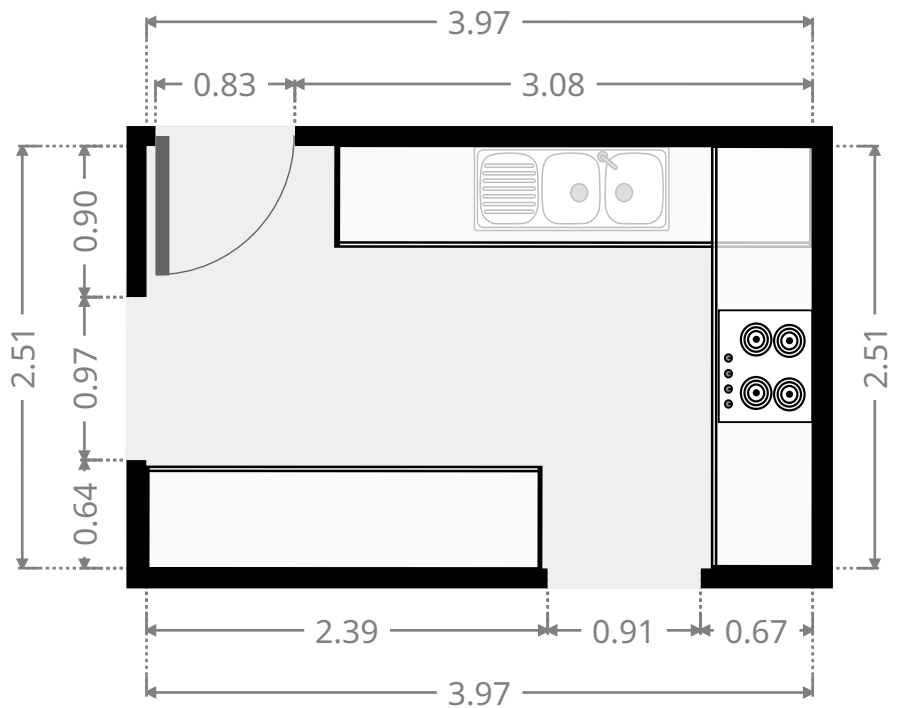
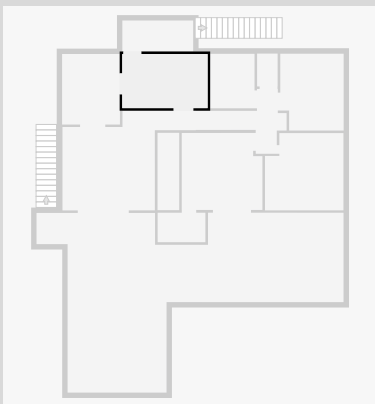

THIS FLOORPLAN IS PROVIDED WITHOUT WARRANTY OF ANY KIND. SENSOPIA DISCLAIMS ANY WARRANTY INCLUDING, WITHOUT LIMITATION, SATISFACTORY QUALITY OR ACCURACY OF DIMENSIONS.

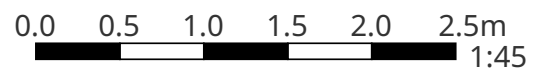

31 Bunya Road

Stairway

Width: 1.01 m
 Length: 3.60 m
 Area: 3.62 m²
 Perimeter: 9.21 m

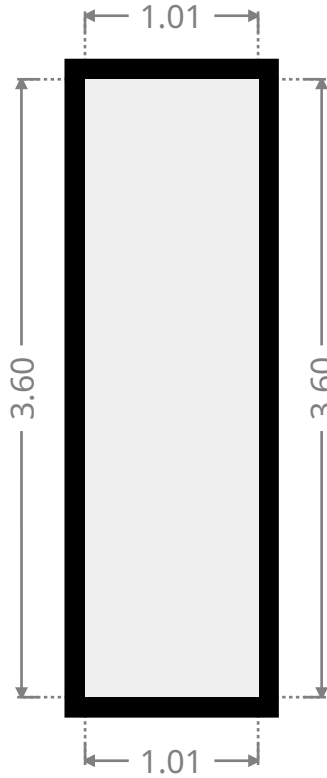
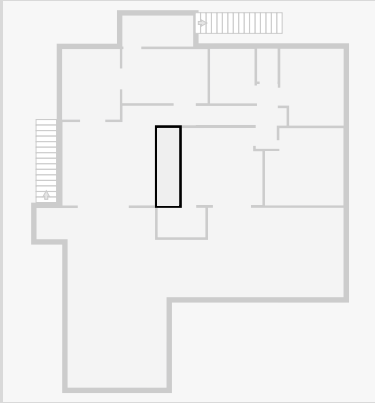

Width: 1.44 m
 Length: 3.29 m
 Area: 4.74 m²
 Perimeter: 9.46 m

