

30 Agnew Avenue

Created on
2021-04-22

Floors
1

▼ Ground Floor

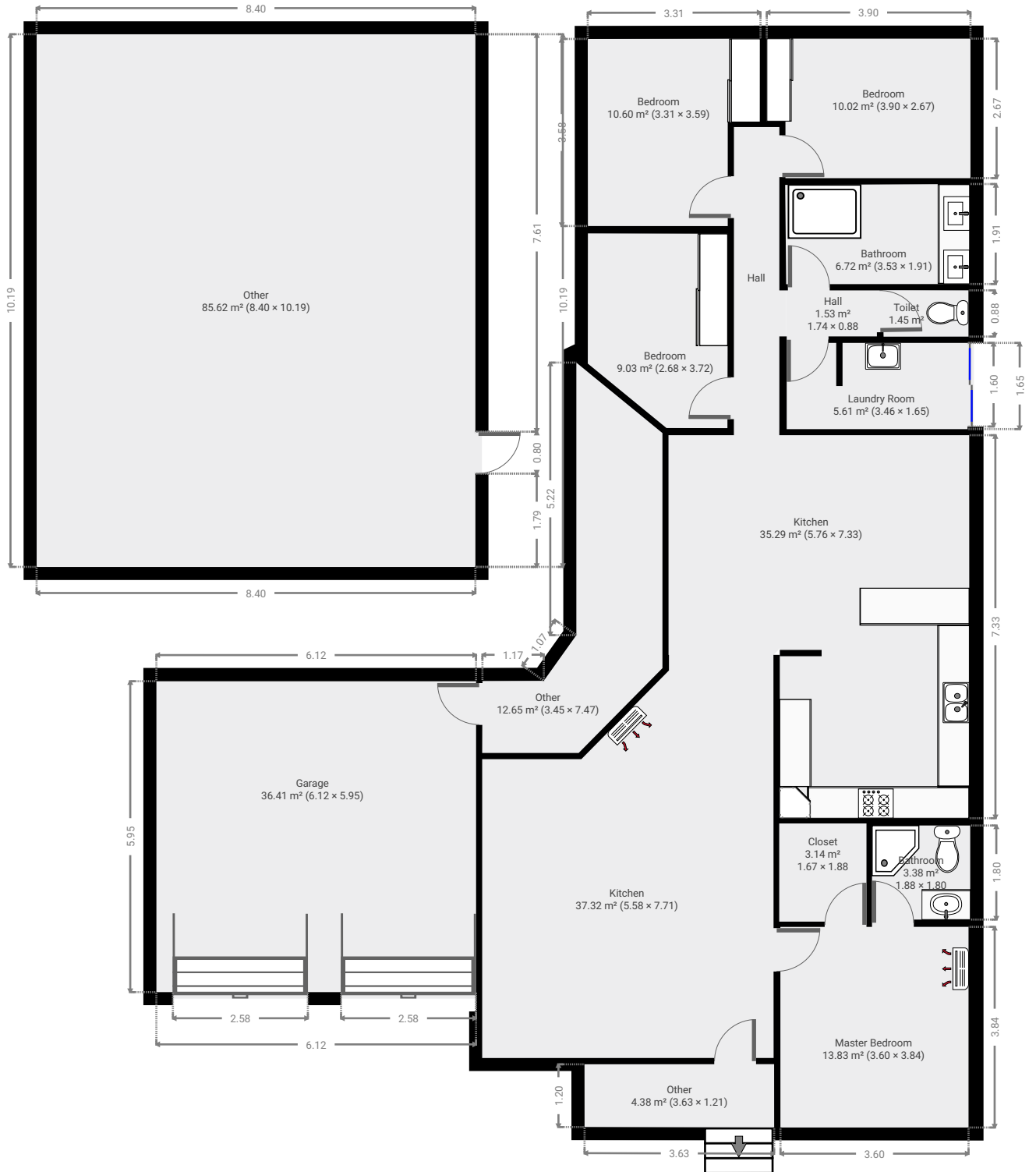

▼ **Bedroom**
Ground Floor

WIDTH: 3.90 m • LENGTH: 2.67 m
AREA: 10.02 m² • PERIMETER: 13.14 m

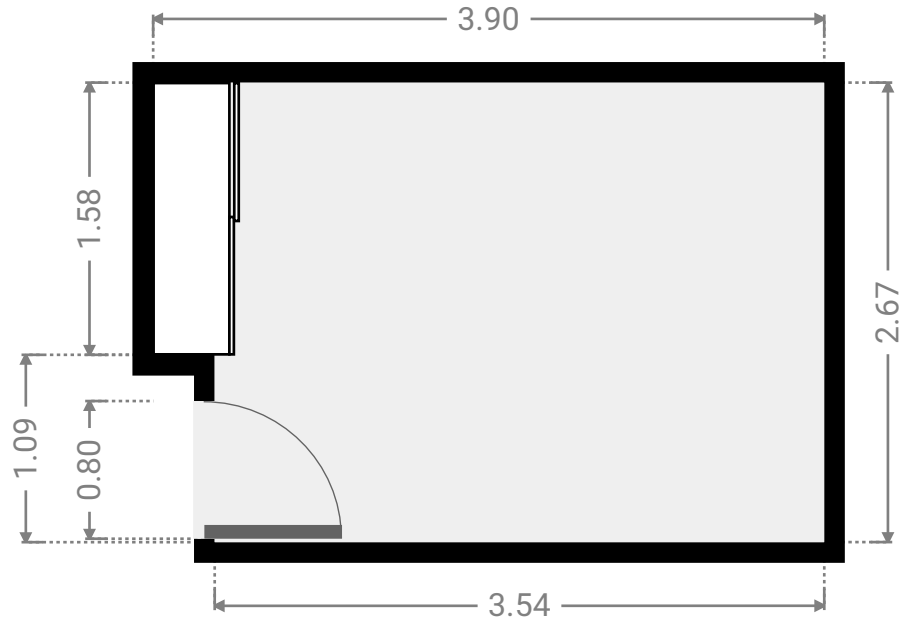
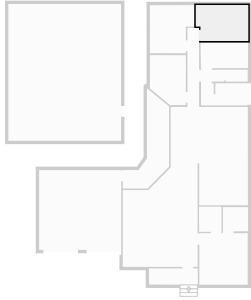

▼ **Other**
Ground Floor

WIDTH: 3.63 m • LENGTH: 1.21 m
AREA: 4.38 m² • PERIMETER: 9.67 m

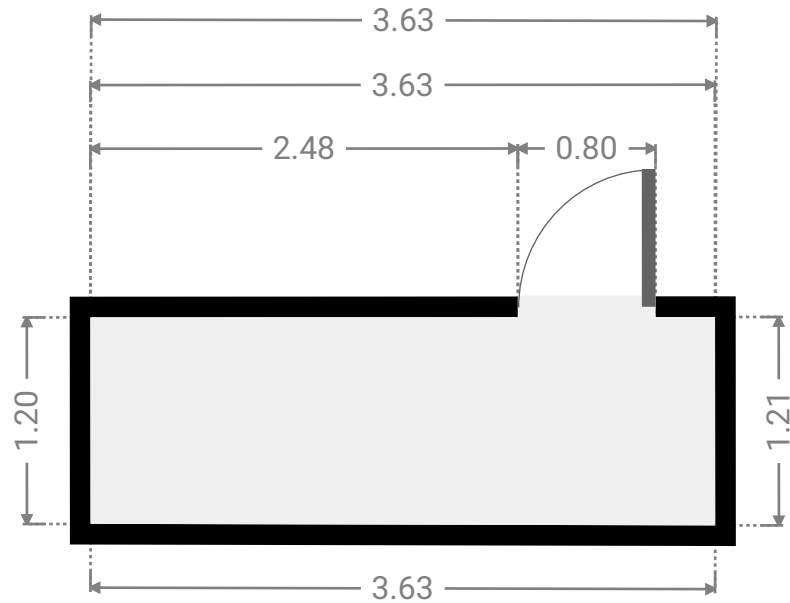
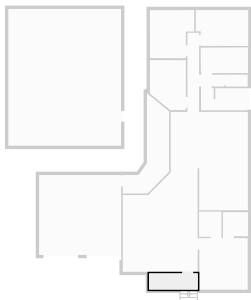

▼ Other
Ground Floor

WIDTH: 8.40 m • LENGTH: 10.19 m
AREA: 85.62 m² • PERIMETER: 37.19 m

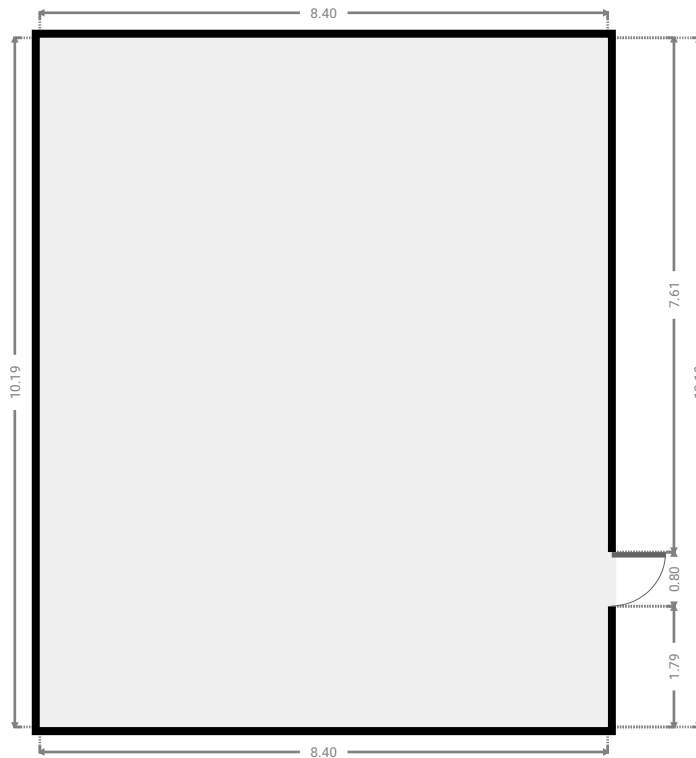
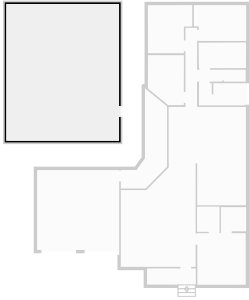

▼ Garage
Ground Floor

WIDTH: 6.12 m • LENGTH: 5.95 m
AREA: 36.41 m² • PERIMETER: 24.14 m

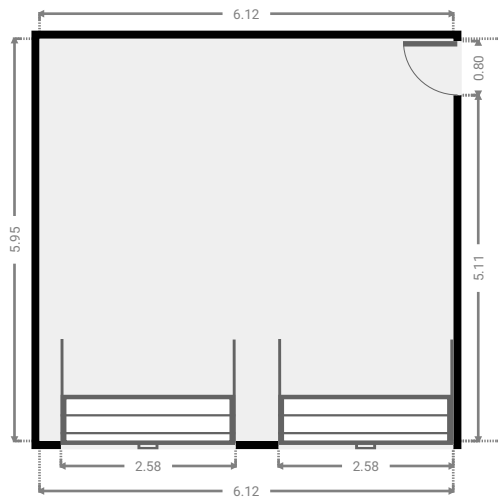
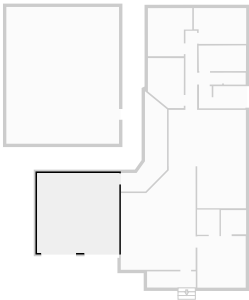

▼ Other
Ground Floor

WIDTH: 3.45 m • LENGTH: 7.47 m
AREA: 12.65 m² • PERIMETER: 19.60 m

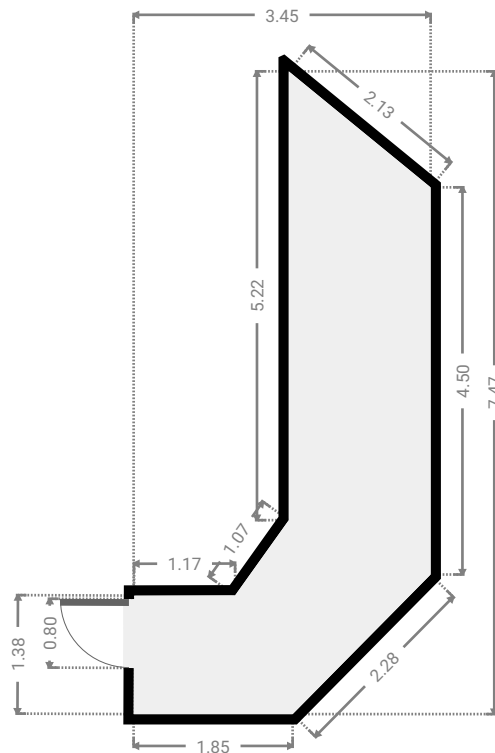
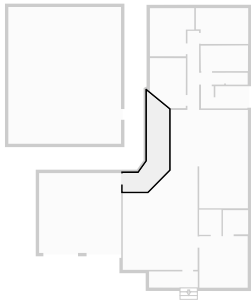

▼ Bathroom
Ground Floor

WIDTH: 3.53 m • LENGTH: 1.91 m
AREA: 6.72 m² • PERIMETER: 10.86 m

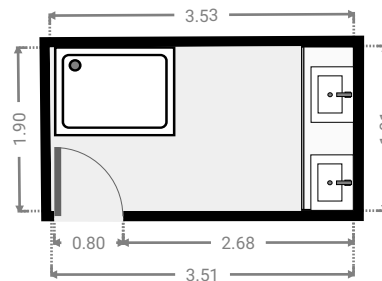
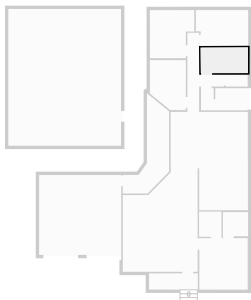

▼ **Toilet**
Ground Floor

WIDTH: 1.64 m • LENGTH: 0.89 m
AREA: 1.45 m² • PERIMETER: 5.04 m

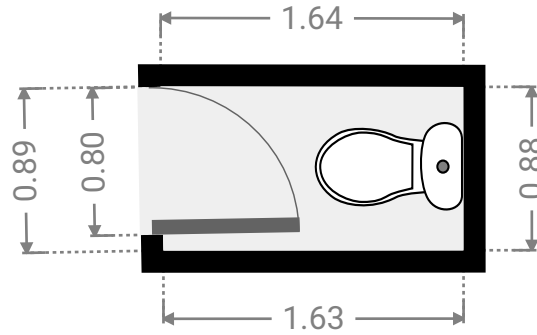

▼ **Hall**
Ground Floor

WIDTH: 1.74 m • LENGTH: 0.88 m
AREA: 1.53 m² • PERIMETER: 5.24 m

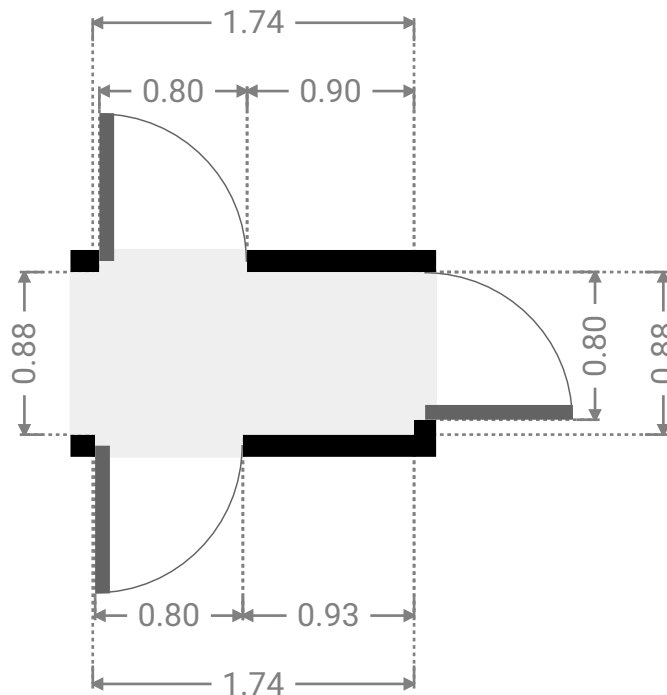
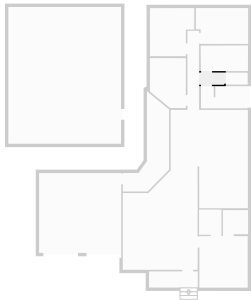

▼ **Laundry Room**
Ground Floor

WIDTH: 3.46 m • LENGTH: 1.65 m
AREA: 5.61 m² • PERIMETER: 11.87 m

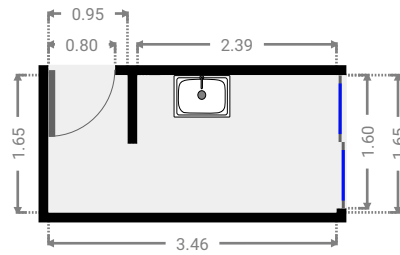
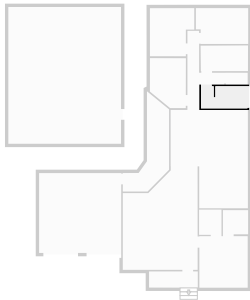

▼ **Kitchen**
Ground Floor

WIDTH: 5.58 m • LENGTH: 7.71 m
AREA: 37.32 m² • PERIMETER: 25.60 m

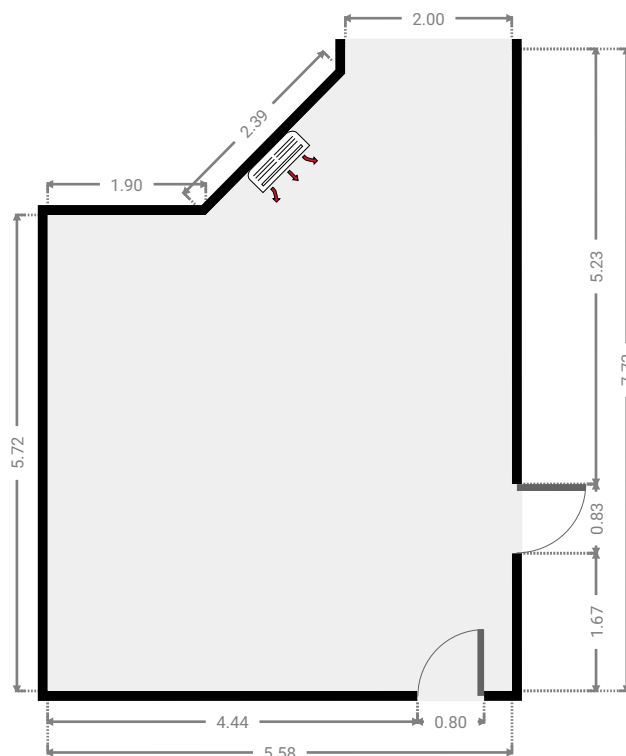
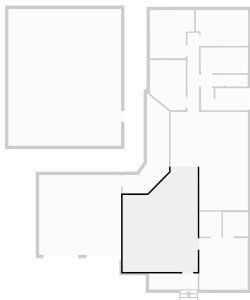

▼ **Bedroom**
Ground Floor

WIDTH: 3.31 m • LENGTH: 3.59 m
AREA: 10.60 m² • PERIMETER: 13.78 m

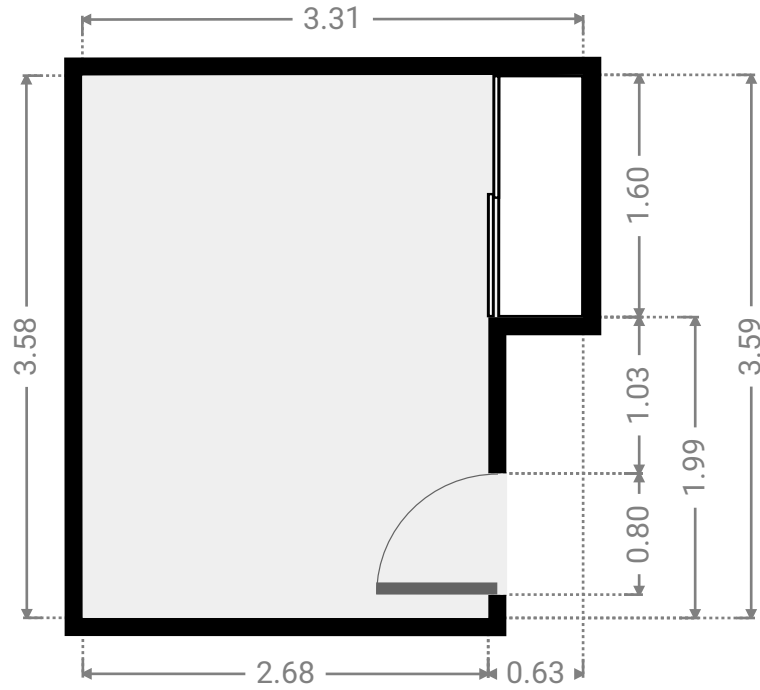
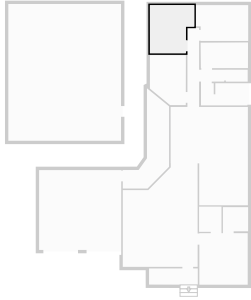

▼ **Bedroom**
Ground Floor

WIDTH: 2.68 m • LENGTH: 3.72 m
AREA: 9.03 m² • PERIMETER: 12.01 m

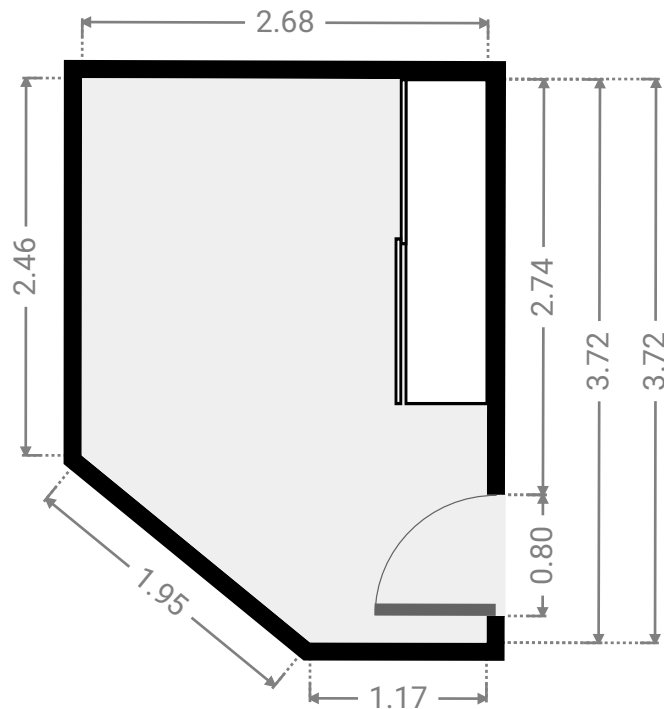
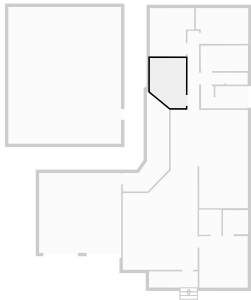

▼ **Hall**
Ground Floor

WIDTH: 0.87 m • LENGTH: 5.80 m
AREA: 5.04 m² • PERIMETER: 13.34 m

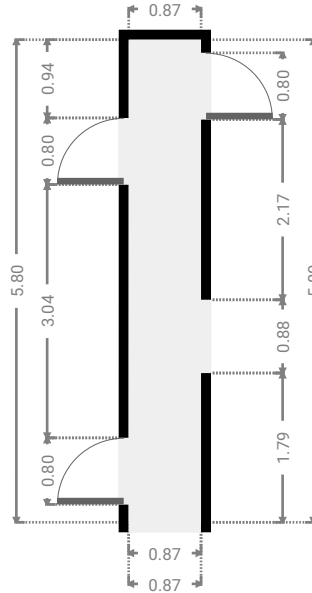
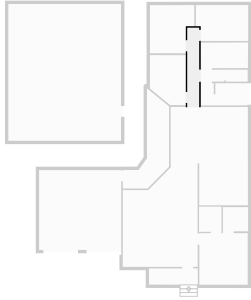

▼ **Kitchen**
Ground Floor

WIDTH: 5.76 m • LENGTH: 7.33 m
AREA: 35.29 m² • PERIMETER: 26.17 m

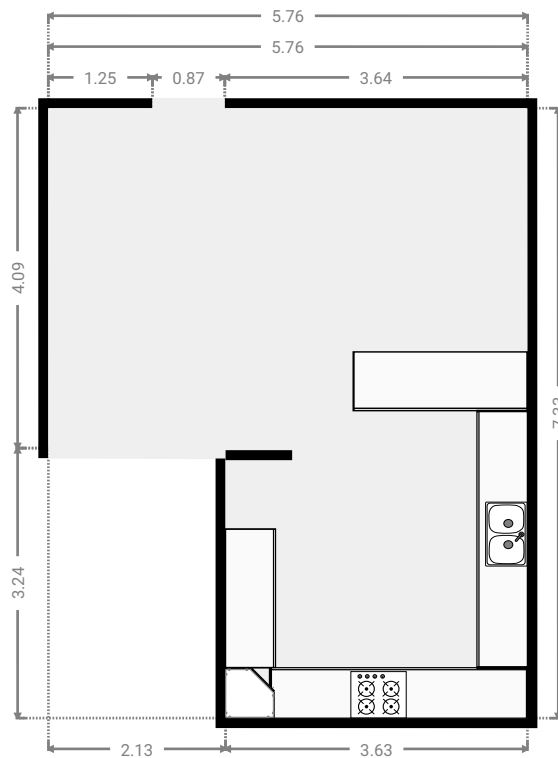
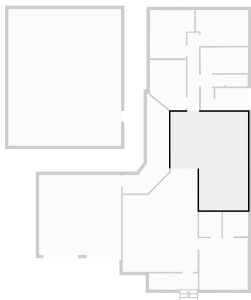

▼ **Bathroom**
Ground Floor

WIDTH: 1.88 m • LENGTH: 1.80 m
AREA: 3.38 m² • PERIMETER: 7.36 m

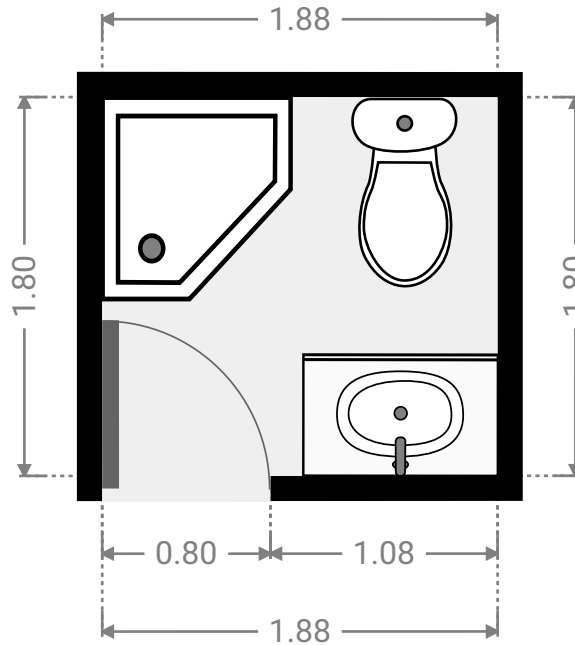
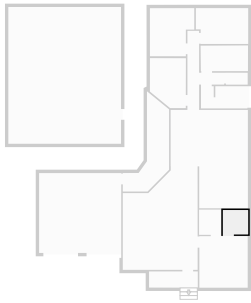

▼ **Closet**
Ground Floor

WIDTH: 1.67 m • LENGTH: 1.88 m
AREA: 3.14 m² • PERIMETER: 7.10 m

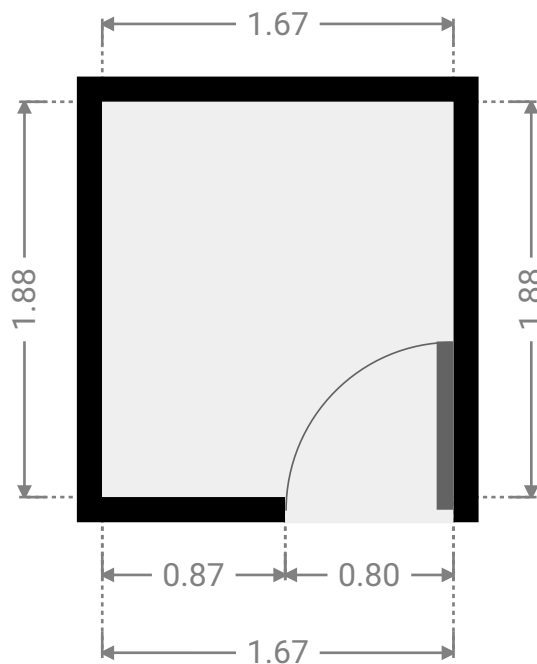
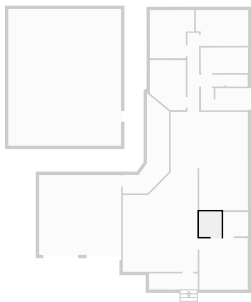

▼ Master Bedroom
Ground Floor

WIDTH: 3.60 m • LENGTH: 3.84 m
AREA: 13.83 m² • PERIMETER: 14.88 m

