

3 Walnut Avenue

Created on
2020-08-27

Floors

1

▼ Ground Floor



THIS FLOORPLAN IS PROVIDED WITHOUT WARRANTY OF ANY KIND. SENSOPIA DISCLAIMS ANY WARRANTY INCLUDING, WITHOUT LIMITATION, SATISFACTORY QUALITY OR ACCURACY OF DIMENSIONS.

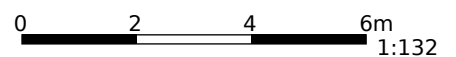

FLOORS: 1

▼ Bedroom Ground Floor

WIDTH: 3.17 m • LENGTH: 3.88 m
AREA: 12.30 m² • PERIMETER: 14.10 m

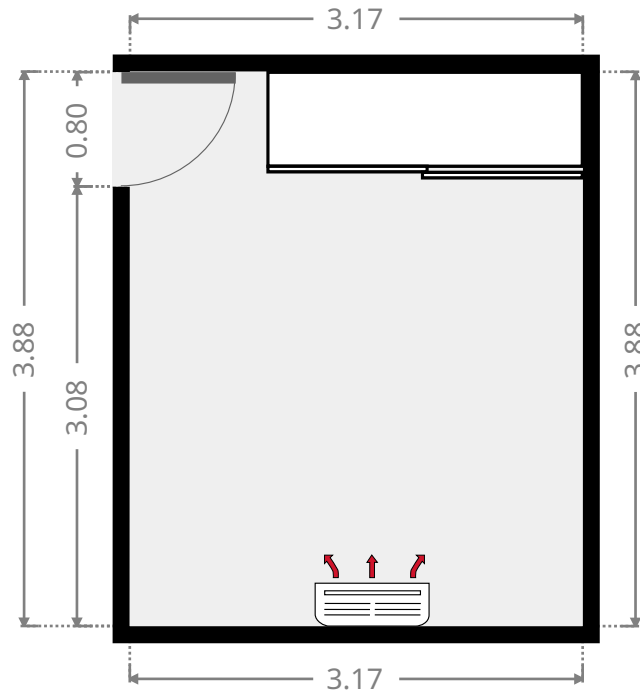
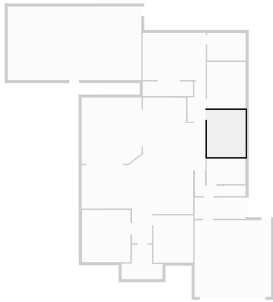

▼ Other Ground Floor

WIDTH: 3.36 m • LENGTH: 2.85 m
AREA: 6.87 m² • PERIMETER: 12.41 m

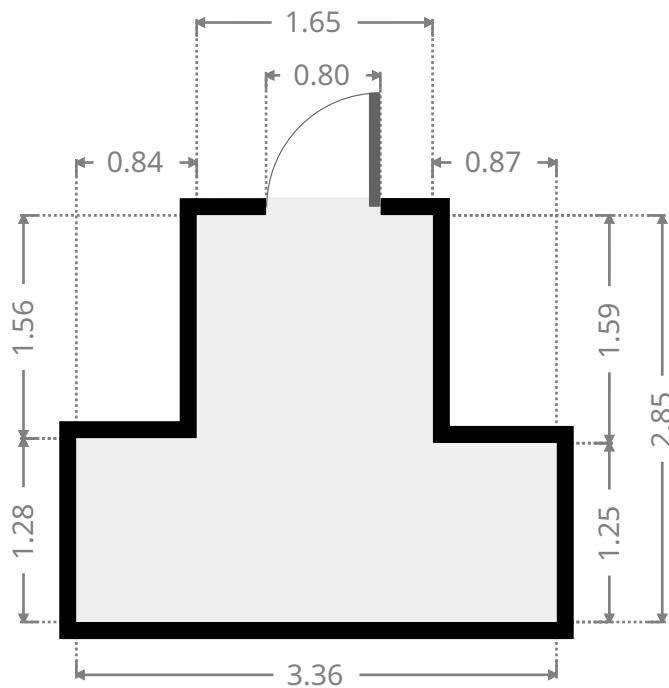
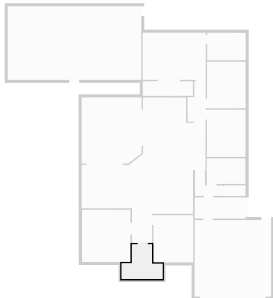

FLOORS: 1

▼ Other Ground Floor

WIDTH: 11.00 m • LENGTH: 6.06 m
AREA: 66.63 m² • PERIMETER: 34.11 m

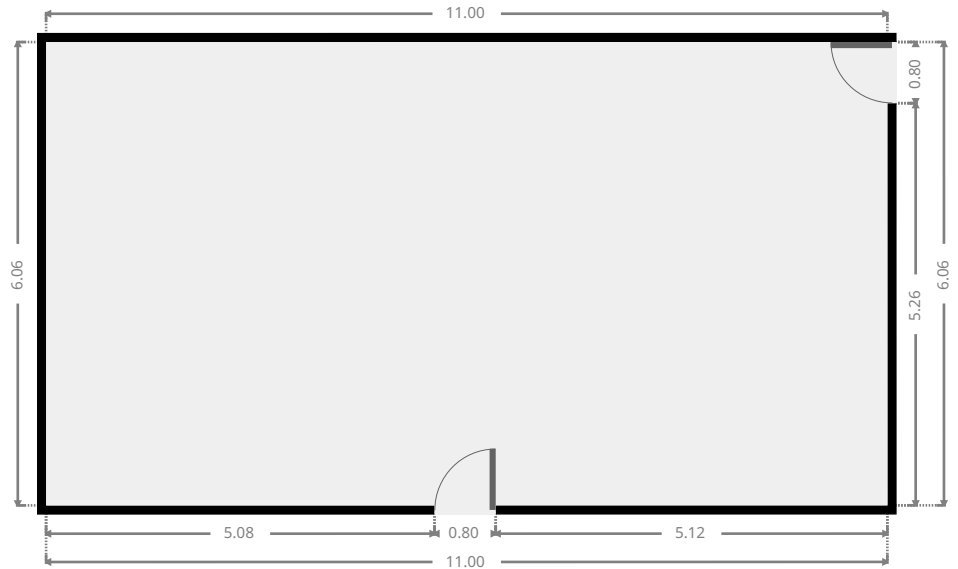
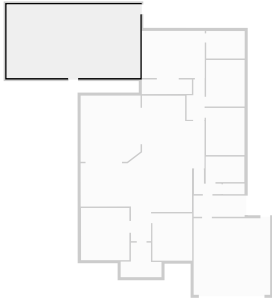

▼ Other Ground Floor

WIDTH: 4.93 m • LENGTH: 5.45 m
AREA: 26.42 m² • PERIMETER: 20.21 m

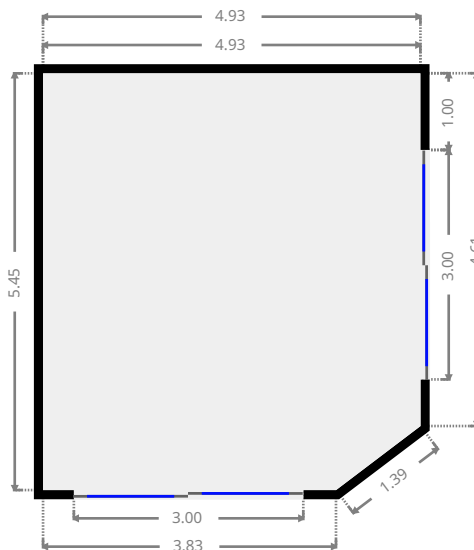
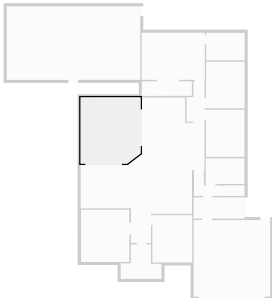

FLOORS: 1

▼ Garage Ground Floor

WIDTH: 6.30 m • LENGTH: 6.30 m
AREA: 39.69 m² • PERIMETER: 25.20 m

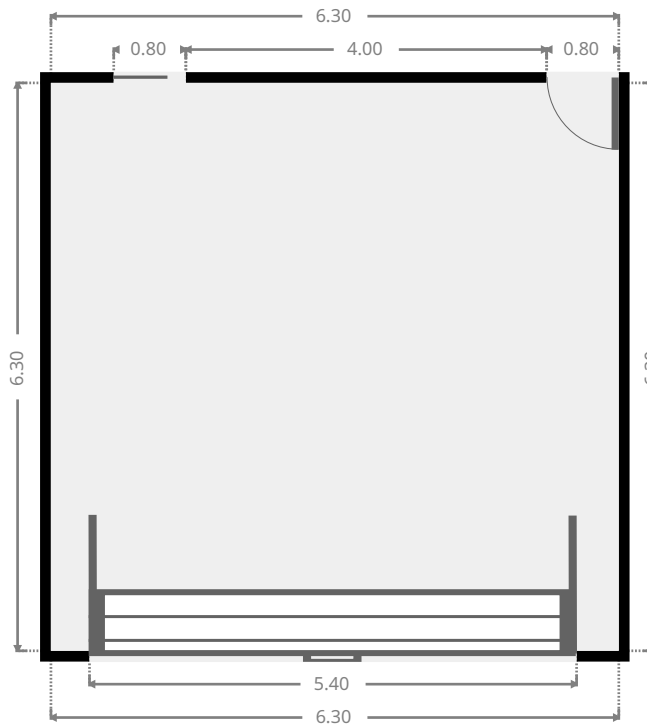
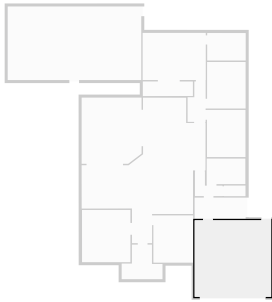

▼ Closet Ground Floor

WIDTH: 4.12 m • LENGTH: 1.20 m
AREA: 4.94 m² • PERIMETER: 10.64 m

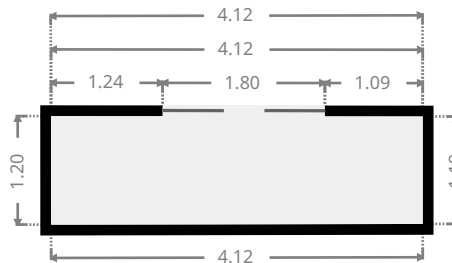
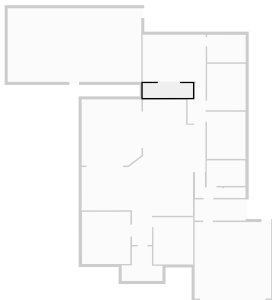

FLOORS: 1

▼ Bathroom Ground Floor

WIDTH: 3.17 m • LENGTH: 2.26 m
AREA: 7.17 m² • PERIMETER: 10.86 m

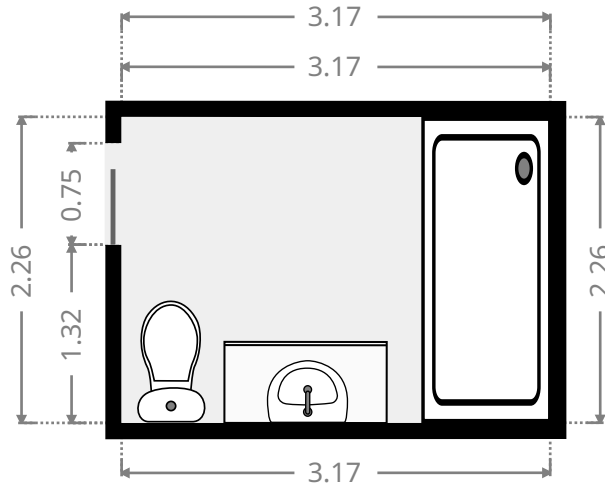
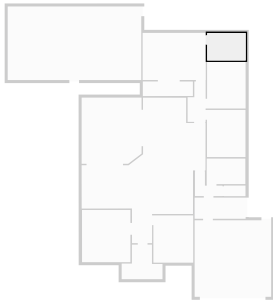

▼ Master Bedroom Ground Floor

WIDTH: 5.20 m • LENGTH: 3.88 m
AREA: 20.18 m² • PERIMETER: 18.16 m

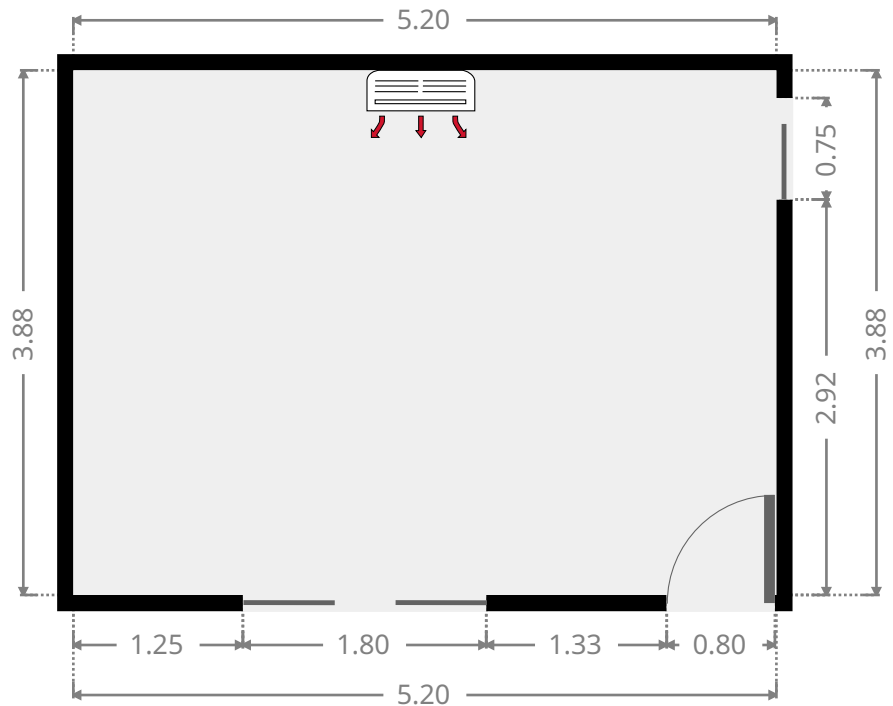
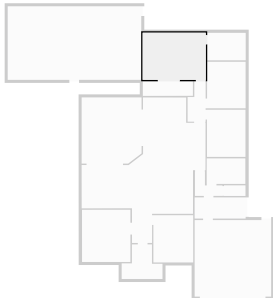

FLOORS: 1

▼ Bedroom Ground Floor

WIDTH: 3.17 m • LENGTH: 3.83 m
AREA: 12.14 m² • PERIMETER: 14.00 m

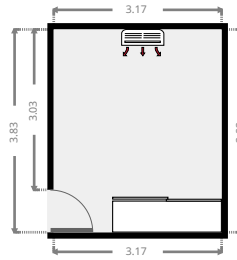
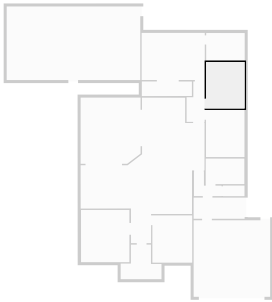

▼ Living Room Ground Floor

WIDTH: 10.20 m • LENGTH: 11.99 m
AREA: 65.20 m² • PERIMETER: 43.77 m

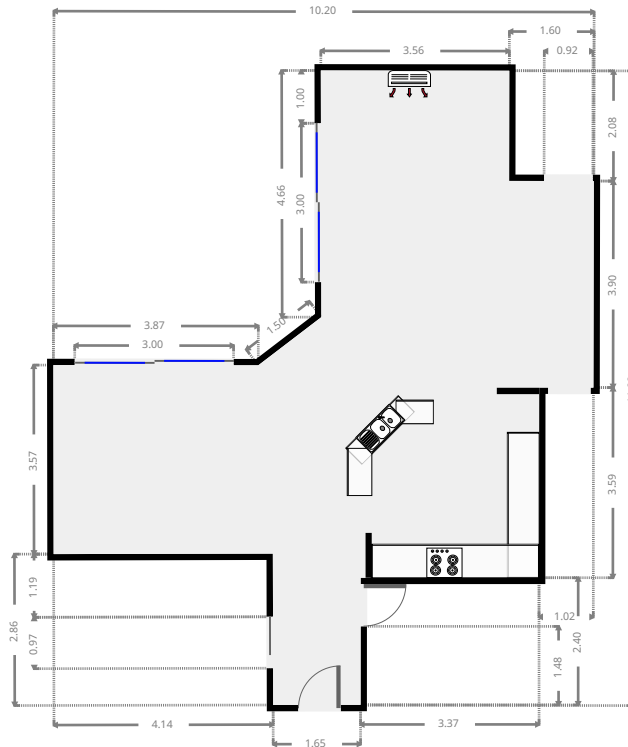
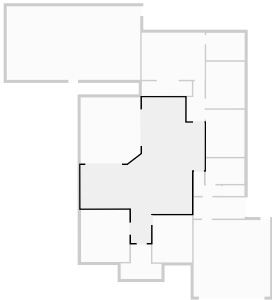

THIS FLOORPLAN IS PROVIDED WITHOUT WARRANTY OF ANY KIND. SENSOPIA DISCLAIMS ANY WARRANTY INCLUDING, WITHOUT LIMITATION, SATISFACTORY QUALITY OR ACCURACY OF DIMENSIONS.

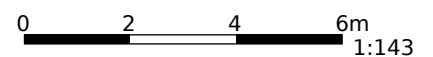

▼ Bathroom Ground Floor

WIDTH: 3.18 m • LENGTH: 2.10 m
AREA: 6.68 m² • PERIMETER: 10.56 m

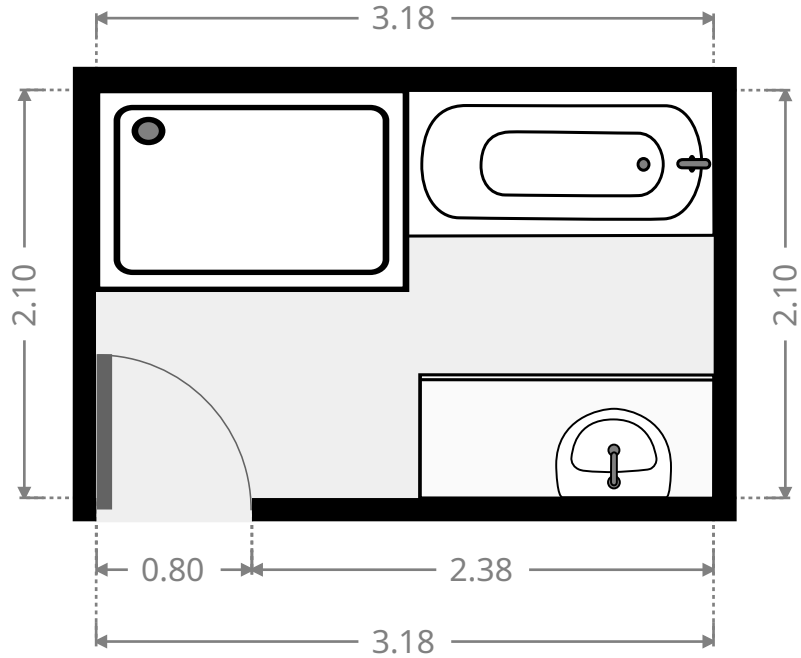
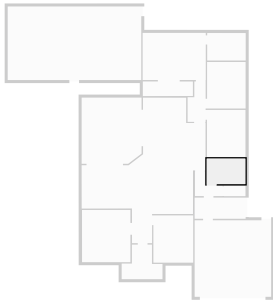

▼ Toilet Ground Floor

WIDTH: 1.77 m • LENGTH: 0.87 m
AREA: 1.55 m² • PERIMETER: 5.29 m

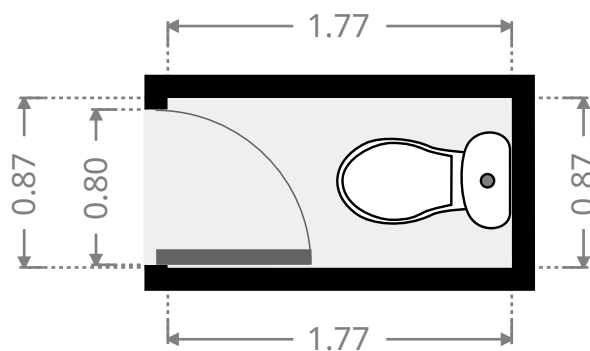
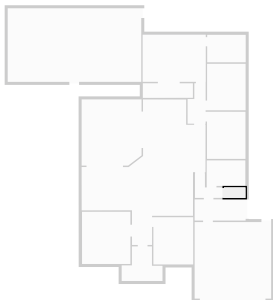

FLOORS: 1

▼ Laundry Room Ground Floor

WIDTH: 4.20 m • LENGTH: 1.74 m
AREA: 7.31 m² • PERIMETER: 11.88 m

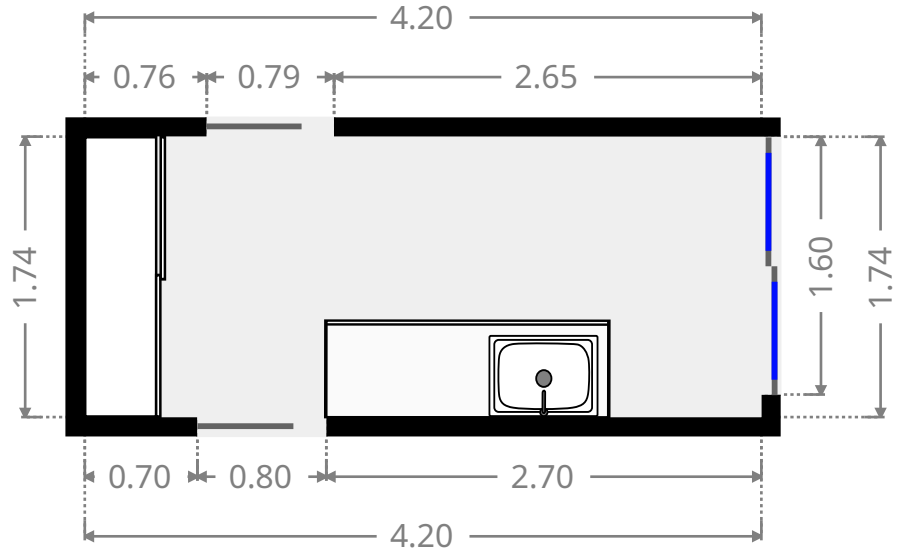
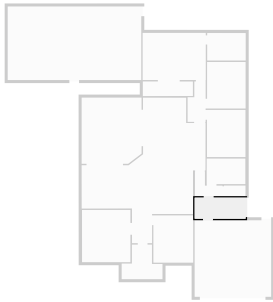

▼ Hall Ground Floor

WIDTH: 2.27 m • LENGTH: 2.00 m
AREA: 2.89 m² • PERIMETER: 8.54 m

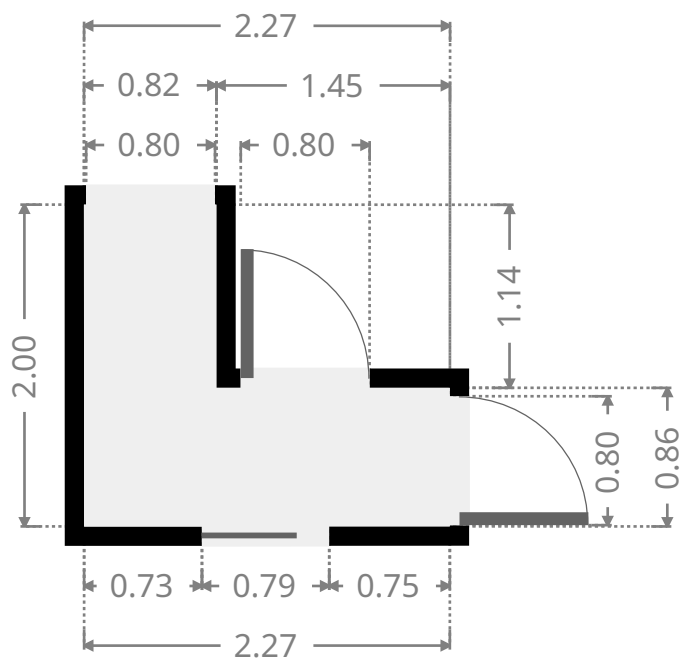
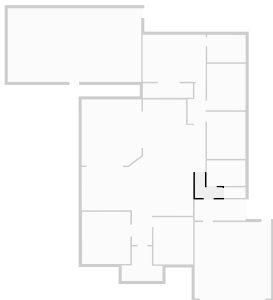

▼ Hallway Ground Floor

WIDTH: 1.48 m • LENGTH: 3.33 m
AREA: 4.22 m² • PERIMETER: 9.63 m

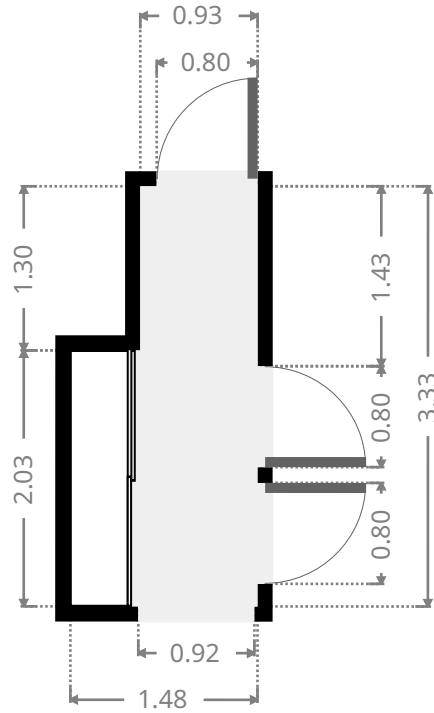
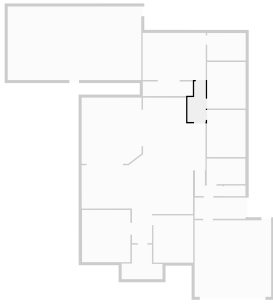

▼ Bedroom Ground Floor

WIDTH: 3.28 m • LENGTH: 3.89 m
AREA: 12.75 m² • PERIMETER: 14.34 m

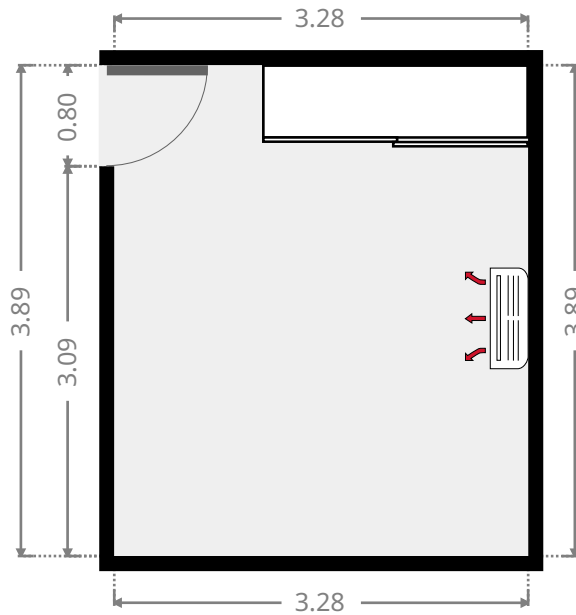
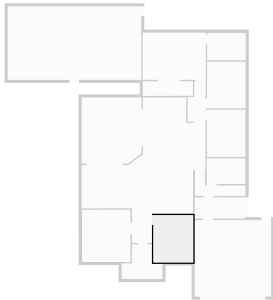

FLOORS: 1

▼ Living Room Ground Floor

WIDTH: 3.98 m • LENGTH: 4.30 m
AREA: 17.12 m² • PERIMETER: 16.56 m

